

omporro 

officine meccaniche porro



**ENRICO CASSINA**

MANUFACTURED BY OFFICINE MECCANICHE PORRO

MANIGLIERIA DI PREGIO DAL 1850



## ARTIGIANI DELL'ECCELLENZA

Nel 1946, dal laboratorio di Alfredo Porro, nasce Officine Meccaniche Porro e quello che era un laboratorio artigiano acquista le dimensioni di un'Azienda senza mai perdere la sua vocazione artigianale.

Negli anni '70 sarà il figlio Giuseppe, ad allargare la gamma di prodotti di grande qualità concepiti e creati con passione, esteticamente pregevoli e tecnologicamente sempre all'avanguardia.

Tutti valori che sono passati anche alla terza generazione della famiglia: Fabio, Donata e Paola che continuano ad offrire una produzione in cui qualità, passione artigianale, estetica e la miglior tecnologia disponibile ben rappresentano l'Eccellenza Italiana in oltre 80 Paesi nel mondo.

## EXCELLENCE IN CRAFTSMANSHIP

In 1946, Alfredo Porro transformed his workshop into Officine Meccaniche Porro, effectively turning a craft laboratory into a corporate endeavor that, however, never lost its artisanal roots.

In the 1970s, Alfredo's son, Giuseppe, broadened the range of high-quality, aesthetically valuable and technologically advanced products designed and created with passion.

These values have been passed on to the Porro Family's third generation: Fabio, Donata and Paola continue to offer today products whose quality, artisanal passion, aesthetics and state-of-the-art technology well represent Italian Excellence in more than 80 countries.

## ENRICO CASSINA

MANUFACTURED BY OFFICINE MECCANICHE PORRO

### MANIGLIERIA DI PREGIO DAL 1850

Il prestigioso marchio Enrico Cassina rappresenta l'apice della qualità e dello stile nella manigliera.

Veri «pezzi d'arte» artigianali nella purezza stilistica che va dal Barocco al Contemporaneo e che consente di completare coerentemente qualsiasi progetto architettonico o di interior design.

Prodotti unici e ricercati presenti nelle ville e negli hotel più prestigiosi in oltre 80 Paesi nel mondo e che, come tutta la produzione Officine Meccaniche Porro, sono garantiti 100% Made in Italy.

### PRESTIGIOUS DOOR HANDLES SINCE 1850

The prestigious Enrico Cassina brand represents the pinnacle of quality and style in door handles. True artisanal "art pieces" whose style ranges from the Baroque to Contemporary themes, and allows completing any architectural or interior design project. Unique and sophisticated products installed in the most prestigious villas and hotels in more than 80 countries, and which, like all Officine Meccaniche Porro production, are guaranteed, 100% Made-in-Italy creations.

## ALFREDO PORRO

MANUFACTURED BY OFFICINE MECCANICHE PORRO

### COMPLEMENTI D'ARREDO IN METALLO NOBILE

Il marchio, dedicato al nostro fondatore, contraddistingue la nostra produzione di complementi per mobili, tende e scale in cui la qualità delle materie prime, la funzionalità e l'aspetto decorativo raggiungono livelli estremamente elevati.

Oggetti curati nel dettaglio, solidi e destinati a durare nel tempo e un gran numero di referenze, di stili, di materiali e di finiture che possono soddisfare ogni esigenza e completare, coerentemente, la nostra offerta di maniglie.

### NOBLE METAL ACCESSORIES

Our brand, dedicated to our founder, defines our production of accessories for furniture, curtains and stairs whose raw material quality, functionality and decorative aspect reach extremely high levels. Solid, durable and carefully detailed items, as well as a large number of references, styles, materials and finishes that can meet any expectation and complete our range of handles.



IL PERFETTO  
INCONTRO  
TRA INDUSTRIA  
E DESIGN

THE PERFECT  
MATCH BETWEEN  
MANUFACTURING  
AND DESIGN

# ENRICO CASSINA

MANUFACTURED BY OFFICINE MECCANICHE PORRO

Fino alla metà dell'Ottocento le belle maniglie erano prerogativa di palazzi nobiliari o ricche dimore; è **Enrico Cassina**, a metà del secolo, ad intuire l'esigenza diffusa di disporre di **maniglie esteticamente pregevoli**.

Inizia così la sua produzione che, grazie a stampi opportunamente creati, può riproporre **maniglie di pregio** a costi più abbordabili, maniglie d'arte e di stile che, oggi, coprono un arco temporale dal **Barocco** al **Contemporaneo**.

È nel 2005 che **Officine Meccaniche Porro** rileva lo storico marchio **Enrico Cassina** avendo così accesso all'ampio **archivio di stampi** che costituisce «un tesoro» per chi ancora produce con passione e molta artigianalità.

Con un certosino lavoro di catalogazione **Officine Meccaniche Porro** ha reso utilizzabile questo storico archivio che - integrato da rivisitazioni e creazioni contemporanee - consente di disporre di una scelta di **maniglie stilisticamente coerenti a tutte le epoche** ed a tutti gli **stili architettonici**.

Splendide maniglie con un **ventaglio di scelta unico e incomparabile** di cui non esistono uguali sul mercato.

**Materie prime nobili e tecnologie meccaniche avanzate**, unite a **finiture artigianali** e manuali, come solo le botteghe artigiane sanno ancora fare, contraddistinguono la produzione **Enrico Cassina**.

Le maniglie e gli accessori per porta del marchio **Enrico Cassina** rappresentano, oggi, il perfetto connubio tra **arte, artigianalità e tecnologia**, tutto rigorosamente **100% Made in Italy**.

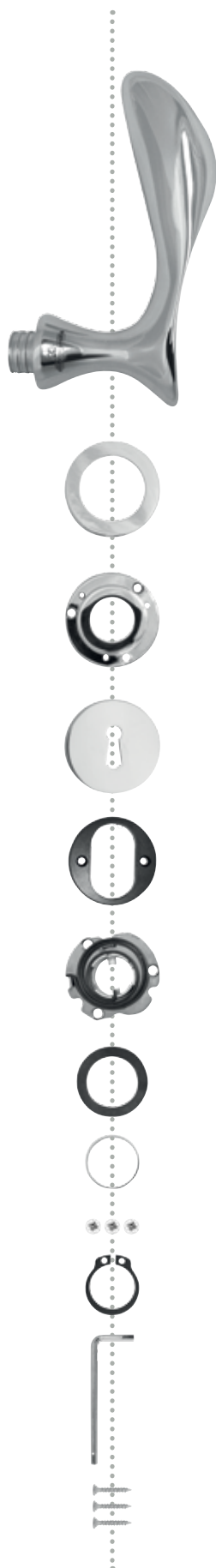

Until the middle of the nineteenth century, beautiful door handles only belonged in noble palaces or stately homes; by then, **Enrico Cassina** well understood the increasing need to produce **aesthetically pleasant handles**.

That is how he began reproducing **exquisite door handles**, which, thanks to the use of casts, were more affordable. Over time, the styles offered covered a broad temporal arch, stretching from the **Baroque** to more **Contemporary** periods.

**Officine Meccaniche Porro** acquired the renowned **Enrico Cassina brand** in 2005, thus gaining access to a **rich inventory of molds** that are nothing short of a treasure for a manufacturer that still produces with passion and craftsmanship.

After painstaking cataloging, **Officine Meccaniche Porro** has made this inventory accessible for use, also enriching it with contemporary creations and adaptations. This precious repertoire inspires the production of **handles that are stylistically consistent with the reference epoch** and all offered **architectural styles**.

They are exquisite products that can be chosen from an **incomparable range** with no rivals on the market.

The **Enrico Cassina** handles marry **noble raw materials** and **mechanically advanced technology** to precious **manual finishes**, just like artisan workshops can do.

**Enrico Cassina** door handles and accessories represent today the perfect marriage among **100% Made-in-Italy art, craftsmanship and technology**.

QUANDO  
LO STILE  
DIVENTA  
ARTE



WHEN  
STYLE  
BECOMES  
ART



Le maniglie **Enrico Cassina** sono **pezzi d'arte** che racchiudono, con estrema maestria, lo **stile dell'epoca** che rappresentano e l'abilità artigianale che porta a particolari finissimi e **finiture manuali di alto valore**, maniglie uniche sul mercato.

La loro realizzazione è resa possibile grazie alle **Officine Meccaniche Porro** che mantiene in essere un **sistema produttivo** altrettanto unico: non «in linea» ma composto da più **botteghe artigianali** che lavorano in sinergia tra loro.

Questa organizzazione del lavoro permette di curare con passione artigianale ogni singola maniglia a cui si applicano i migliori meccanismi disponibili, molti brevettati ed unici sul mercato, per farne oggetti oltre che **stilisticamente perfetti meccanicamente all'avanguardia**.

La produzione di maniglie Enrico Cassina si fonda su una storia di **ricerca stilistica**, lunga 150 anni, che va dal Barocco al Contemporaneo, permettendo ad Architetti ed Interior Designer, così come ai **Clienti più esigenti**, di disporre di maniglie coerenti con il proprio progetto o con la propria **abitazione di prestigio**.

Ogni maniglia Enrico Cassina, prodotta solo con **materie prime di elevatissima qualità**, viene **manualmente rifinita** da esperti artigiani che con passione producono veri e propri pezzi d'arte, unici e 100% Made in Italy.

The **Enrico Cassina handles** are **unique works of art** that embody, with great mastery, **the style of the times** they represent, as well as the craftsmanship that ensures great attention to detail and **highly valuable manual finishes**.

Their production is made possible by **Officine Meccaniche Porro** and its unique **manufacture system**, one that is not linear, but comprising a series of **artisan workshops** that operate in synergy with one another.

This work organization allows producing every single handle with utmost attention and the use of mechanisms, many of which are patented and thus unique on the market, that enable the creation of **stylistically and mechanically perfect objects**.

The production of Enrico Cassina handles leverages a more than 150-year long **search for style** encompassing art periods stretching from the Baroque to the Contemporary age, thus allowing Architects and Interior Designers, as well as the **most demanding customers**, to have handles that meet their specifications or are perfect complement of their **elegant homes**.

Every Enrico Cassina handle, produced only with **raw materials of the highest quality**, is **manually finished** by skilled craftsmen who passionately produce real pieces of unique and 100% Made-in-Italy art.

# LA PUREZZA DELLO STILE DAL BAROCCO AL CONTEMPORANEO



Fare una maniglia «in stile» è un esercizio che riesce a molti, fare delle maniglie rispettando la **purezza dello stile** riesce solo ad **Enrico Cassina**.

Non solo perché Enrico Cassina può contare su un archivio di stampi storico e ineguagliabile, ma anche perché la «purezza dello stile» si coglie nei **particolari più minuti** che richiedono, oggi come 150 anni fa, **l'intervento manuale** di **esperti artigiani** che Officine Meccaniche Porro è in grado di garantire.



# PURITY OF STYLE FROM BAROQUE TO CONTEMPORARY THEMES

BAROCCO ITALIANO  
ITALIAN BAROQUE



LUIGI XV  
LOUIS XV



LUIGI XVI  
LOUIS XVI

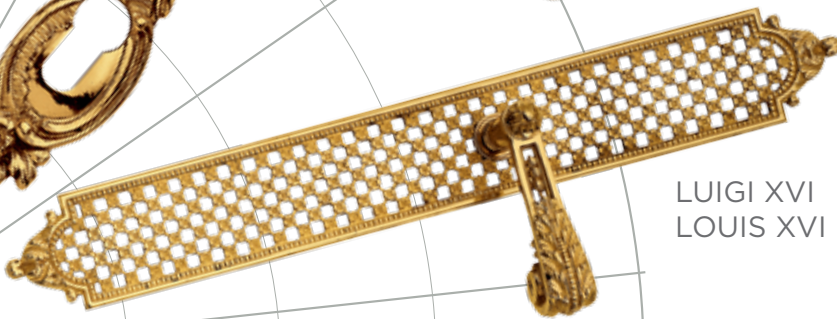

PRIMO IMPERO  
FIRST EMPIRE

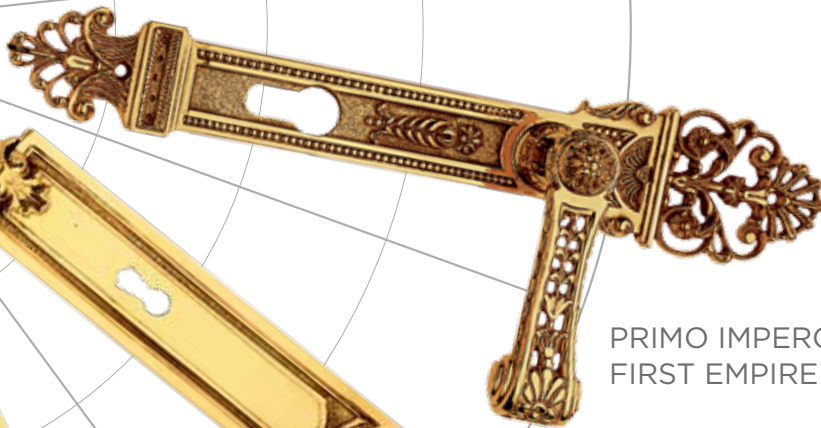

SECONDO IMPERO  
SECOND EMPIRE



COLONIALE  
COLONIAL

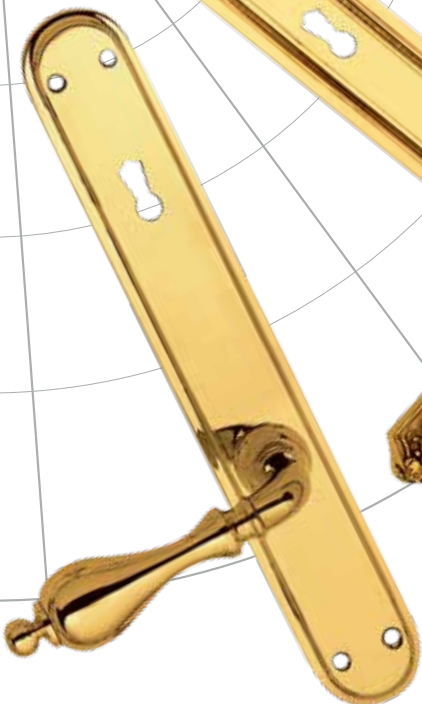

Many can make a stylish handle; making handles that respect **purity of style** is, however, something that only **Enrico Cassina** can do.

Not only because Enrico Cassina can count on a rich and unrivalled inventory of historical and unique molds, but also because “purity of style” is achieved through the **smallest details** that, today like 150 years ago, require **experienced craftsmen** that only Officine Meccaniche Porro can provide.

# INDICE

---

## MODERNO/MODERN

ART NOUVEAU ..... pag 10



NOVECENTO/XX CENTURY ..... pag 16



ART DÉCO ..... pag 50



TRENTA/THIRTIES ..... pag 56



CINQUANTA/FIFTIES ..... pag 78



THE SIGN PROJECT ..... pag 96



## COLOR TRENDS

ROCOCÒPOP ..... pag 104



POP GUM ..... pag 108



# INDEX

## CLASSICO/CLASSIC

BAROCCO ITALIANO/ITALIAN BAROQUE ..... pag 112



LUIGI XV/LOUIS XV ..... pag 126



LUIGI XVI/LOUIS XVI ..... pag 136



PRIMO IMPERO/FIRST EMPIRE ..... pag 144

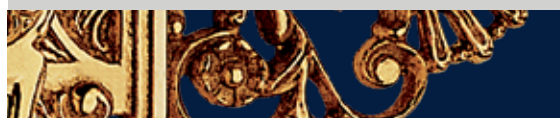

SECONDO IMPERO/SECOND EMPIRE ..... pag 166



COLONIALE/COLONIAL ..... pag 176



## MATERIE PREZIOSE/PRECIOUS MATERIALS

MURRINA/MURANO GLASS ..... pag 190



MOSAICO/MOSAIC ..... pag 194

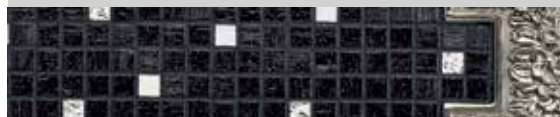

MADREPERLA/MOTHER OF PEARL ..... pag 198



CRISTALLI/CRYSTALS ..... pag 202



## PERSONALIZZAZIONI/BESPOKE SERVICE

..... pag 206

## ACCESSORI PORTA/DOOR ACCESSORIES

..... pag 208



# INDICE

<b>CODICE CODE</b>	<b>PAGINA PAGE</b>	<b>NOME NAME</b>	<b>COLLEZIONE COLLECTION</b>
<b>169M/MQ</b>	192	Murrina/Murano Glass	Precious Materials
<b>716</b>	160	Ortensia	Primo Impero/First Empire
<b>722</b>	164	Carlotta	Primo Impero/First Empire
<b>3000</b>	74	Ada	Trenta/Thirties
<b>4800</b>	184	Emanuela	Coloniale/Colonial
<b>4801</b>	76	Anja	Trenta/Thirties
<b>4802</b>	28	Susanne	Novecento/XX Century
<b>4803</b>	90	Kazuyo	Cinquanta/Fifties
<b>4806</b>	186	Indira	Coloniale/Colonial
<b>4807</b>	92	Odile	Cinquanta/Fifties
<b>4809</b>	20	Eileen	Novecento/XX Century
<b>C007</b>	170	Eleonore	Secondo Impero/Second Empire
<b>C012</b>	120	Elisabetta	Barocco Italiano/Italian Baroque
<b>C016</b>	138	Marie-Antoinette	Luigi XVI/Louis XVI
<b>C018</b>	140	Gabrielle	Luigi XVI/Louis XVI
<b>C019</b>	118	Artemisia	Barocco Italiano/Italian Baroque
<b>C020</b>	154	Letizia	Primo Impero/First Empire
<b>C024</b>	64	Marisa	Trenta/Thirties
<b>C029</b>	58	Maya	Trenta/Thirties
<b>C030</b>	200	Madreperla	Madreperla/Mother of Pearl
<b>C030 SW</b>	204	Cristalli	Cristalli/Crystals
<b>C043</b>	122	Barbara	Barocco Italiano/Italian Baroque
<b>C044</b>	66	Elena	Trenta/Thirties
<b>C050</b>	152	Paolina	Primo Impero/First Empire
<b>C051</b>	142	Sofia	Luigi XVI/Louis XVI
<b>C054</b>	62	Dorotea	Trenta/Thirties
<b>C066</b>	80	Wijdan	Cinquanta/Fifties
<b>C067</b>	134	Adelaide	Luigi XV/Louis XV
<b>C068</b>	84	Gae	Cinquanta/Fifties
<b>C069</b>	82	Anna	Cinquanta/Fifties
<b>C070</b>	86	Afra	Cinquanta/Fifties
<b>C078</b>	34	Niky	Novecento/XX Century
<b>C079</b>	88	Huang	Cinquanta/Fifties
<b>C082</b>	68	Carla-Maria	Trenta/Thirties
<b>C083</b>	158	Stefania	Primo Impero/First Empire
<b>C087</b>	168	Eugenie	Secondo Impero/Second Empire

## INDEX

<b>CODICE CODE</b>	<b>PAGINA PAGE</b>	<b>NOME NAME</b>	<b>COLLEZIONE COLLECTION</b>
<b>C090</b>	156	Carolina	Primo Impero/First Empire
<b>C091</b>	132	Du Barry	Luigi XV/Louis XV
<b>C092</b>	70	Elvira	Trenta/Thirties
<b>C093</b>	72	Topazia	Trenta/Thirties
<b>C094</b>	12	Franca	Art Nouveau
<b>C095</b>	54	Annelise	Art Déco
<b>C096</b>	14	Tamara	Art Nouveau
<b>C099</b>	36	Lina	Novecento/XX Century
<b>C101</b>	24	Jeanne	Novecento/XX Century
<b>C110</b>	150	Elisa	Primo Impero/First Empire
<b>C119</b>	130	Pompadour	Luigi XV/Louis XV
<b>C120</b>	114	Lavinia	Barocco Italiano/Italian Baroque
<b>C121</b>	178	Vittoria	Coloniale/Colonial
<b>C122</b>	174	Virginia	Secondo Impero/Second Empire
<b>C12510</b>	148	Marie-Louise	Primo Impero/First Empire
<b>C12512</b>	146	Giuseppina	Primo Impero/First Empire
<b>C126</b>	38	Liisi	Novecento/XX Century
<b>C127</b>	182	Menen	Coloniale/Colonial
<b>C128</b>	128	Marie	Luigi XV/Louis XV
<b>C128 POP</b>	106	Rococòpop	Rococòpop
<b>C130</b>	18	Margherita	Novecento/XX Century
<b>C135</b>	172	Matilde	Secondo Impero/Second Empire
<b>C138</b>	44	Melanie	Novecento/XX Century
<b>C140</b>	180	Clementina	Coloniale/Colonial
<b>C142</b>	48	Aleksandra	Novecento/XX Century
<b>C151</b>	32	Signe	Novecento/XX Century
<b>C162</b>	46	Dora	Novecento/XX Century
<b>C173</b>	30	Lilly	Novecento/XX Century
<b>C175</b>	98	Filobì	The Sign Project
<b>C176</b>	100	Baricò	The Sign Project
<b>C177</b>	102	Soberal	The Sign Project
<b>C178</b>	52	Marianne	Art Déco
<b>C192</b>	42	Jing	Novecento/XX Century
<b>C193</b>	40	Marion	Novecento/XX Century
<b>C195</b>	110	Pop Gum	Pop Gum
<b>C471/2/3</b>	196	Mosaico	Mosaico/Mosaic



ART  
**NOUVEAU**

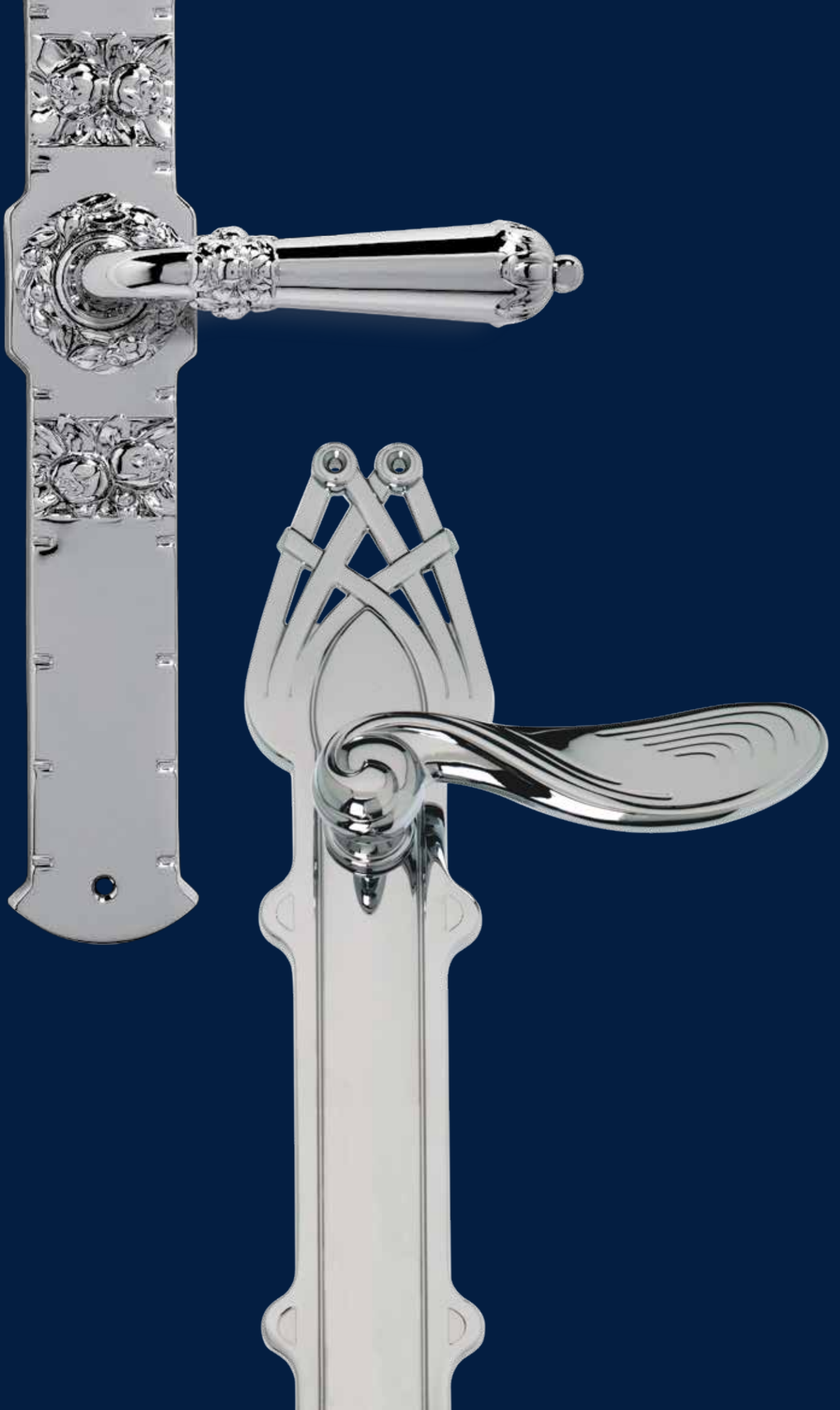

ART NOUVEAU

FRANCA

C09410





# Mod. FRANCA

## C09410

Designed by ENRICO CASSINA



**C09410**  
141x325

Privacy  
**C09410/5**  
141x325



**C09411**  
131x84



**C09411/5**  
131x84



**C54500**  
75x34



**C09411 DK**  
30x141



**C09420**  
45x195



**C29400**  
48x118

Disponibile  
versione  
girevole **C29400 Q**  
(abbinabile con  
bocchetta **CB1384**)  
Revolving version  
available **C29400 Q**  
(matching escutcheon  
article **CB1384**)



**C09450**  
48x333

ART NOUVEAU

TAMARA

C09610



# Mod. TAMARA

## C09610

Designed by ENRICO CASSINA



**C09610**  
132x250

Privacy  
**C09610/5**  
132x250



**C09611**  
133x50



**C09611/5**  
133x50



**C54900**  
88x30



**C09620**  
38x160



**C09611 DK**  
30x141



**C09650**  
48x360



**NOVECENTO**

**XX CENTURY**



NOVECENTO/XX CENTURY

# MARGHERITA

C13010



# Mod. MARGHERITA

## C13010

Designed by ENRICO CASSINA



**C13010**  
133x247

Privacy  
**C13010/5**  
133x247



**C13011**  
136x45



**C13011/5**  
136x45



Con la rosetta Ø45mm non è possibile utilizzare la molla e il foro cilindro. With the 45mmØ rose the spring and the yale keyhole can not be used.



**C54500**  
75x34



**C13070**  
44x242



**C13020**  
38x145



**C13011 DK**  
30x146



**C13050**  
45x275

NOVECENTO/XX CENTURY

EILEEN

4809





# Mod. EILEEN

## 4809

Designed by ENRICO CASSINA

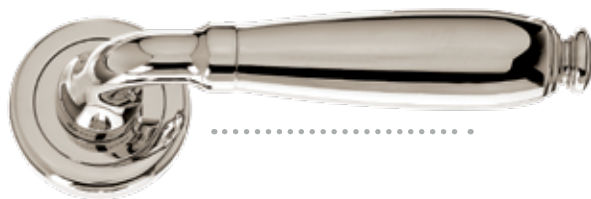

**480901**  
139x223

Privacy  
**480901/5**  
139x223



**480990**  
145x50



**480990/5**  
145x50



**C54500**  
75x34



**4809 DK**  
30x152

# Mod. EILEEN

**4809**

Designed by ENRICO CASSINA

ENTRANCE SET

.....



**830057\_AC**  
**830000**  
70x503  
155x340



**830157\_AC**  
**830100**  
70x495  
155x340



**831057\_AC**  
**831000**  
70x503  
70x340



**831157\_AC**  
**831100**  
70x495  
70x340

# Mod. EILEEN

## 4809

Designed by ENRICO CASSINA

### INTERIOR SET

---



**480992**

153x66

**CPR** - Privacy  
**CPA** - Passage  
**CDU** - Dummy



**485392**

Ø66

**CPR** - Privacy  
**CPA** - Passage  
**CDU** - Dummy

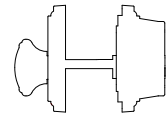

**8300DR**

Ø66

**SC** - Single Cylinder  
**DC** - Double Cylinder

---

### INSIDE SET

---



**8300EP**

155x340

**CPR** - Privacy  
**CPA** - Passage  
**CAC** - Cylinder  
**C5** - Privacy EUROPEAN  
**CPE** - Passage EUROPEAN  
**C2** - Cylinder EUROPEAN



**8310EP**

70x340

**CPR** - Privacy  
**CPA** - Passage  
**CAC** - Cylinder  
**C5** - Privacy EUROPEAN  
**CPE** - Passage EUROPEAN  
**C2** - Cylinder EUROPEAN

---

### MULTIPOINT

---



**480920**

140x240

**C25** - Double Cylinder  
**C05** - Passage  
**C26** - Patio

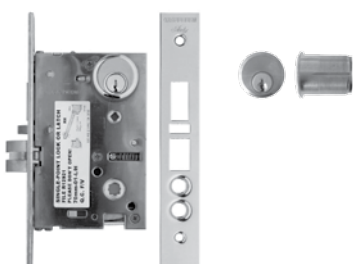

**C400S**

**29**  
**32**  
**35**  
**38**

Disponibile serratura  
Mortise lock available

NOVECENTO/XX CENTURY

JEANNE

C10110



# Mod. JEANNE

## C10110

Designed by ENRICO CASSINA



**C10110**  
130x238  
**C10116**  
149x238

Privacy  
**C10110/5**  
130x238  
**C10116/5**  
149x238



**C10111**  
137x58  
**C10117**  
156x58



**C10111/5**  
137x58  
**C10117/5**  
156x58

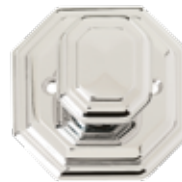

**C54300**  
86x33



**C10170**  
50x229



**C10120**  
38x158



**C10110 DK**  
39x148



**C10150**  
58x272

# Mod. JEANNE

## C10110

Designed by ENRICO CASSINA

## ENTRANCE SET



**C32100**

**Asta C319AS non inclusa  
nella confezione**

Rod C319AS is not  
included in the package

**C30500**

- 25** (Asta/Rod L 250 mm)
- 30** (Asta/Rod L 300 mm)
- 35** (Asta/Rod L 350 mm)
- 40** (Asta/Rod L 400 mm)



**C41000\_AC**

70x523  
70x143

**C41000\_00**

70x523  
70x143



**C20100**

58x58xh64

Disponibile  
versione  
girevole **C20100 Q**  
(abbinabile con  
bocchetta **CB1558**)  
Revolving version  
available **C20100 Q**  
(matching escutcheon  
article **CB1558**)



NOVECENTO/XX CENTURY

# SUSANNE

4802





# Mod. SUSANNE

**4802**

Designed by ENRICO CASSINA



**480291**  
126x50



**480291/5**  
126x50



**C54300**  
86x33



**4802 DK**  
30x133

NOVECENTO/XX CENTURY

LILLY

C17310



# Mod. LILLY

## C17310

Designed by ENRICO CASSINA



**C17310**  
126x246

Privacy  
**C17310/5**  
126x246



**C17311**  
129x45



**C17311/5**  
129x45

Con la rosetta Ø45mm non è possibile utilizzare la molla e il foro cilindro. With the 45mmØ rose the spring and the yale keyhole can not be used.



**C54500**  
75x34



**C17370**  
44x265



**C17320**  
38x145



**C17311 DK**  
30x139



**C17350**  
45x251

NOVECENTO/XX CENTURY

SIGNE

C15110



# Mod. SIGNE

## C15110

Designed by ENRICO CASSINA



**C15110**  
142x224

Privacy  
**C15110/5**  
142x224



**C15170**  
44x267



**C15120**  
39x153



**C15111 DK**  
30x155

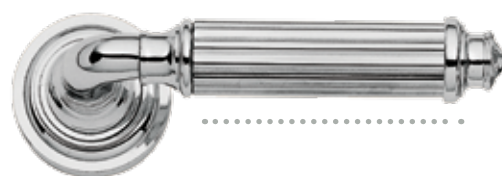

**C15111**  
145x45



**C15111/5**  
145x45

Con la rosetta Ø45mm non è possibile utilizzare la molla e il foro cilindro.

With the 45mmØ rose the spring and the yale keyhole can not be used.



**C54500**  
75x34



**CB1968**  
Ø68



**C48800**  
**400** (68x513)  
**600** (68x713)  
**800** (68x913)

NOVECENTO/XX CENTURY

NIKY

C07810



Mod. NIKY

**C07810**

Designed by ENRICO CASSINA



**C07810**  
120x247

Privacy  
**C07810/5**  
120x247



**C07811**  
122x45



**C07811/5**  
122x45

Con la rosetta Ø45mm non è possibile utilizzare la molla e il foro cilindro.

With the 45mmØ rose the spring and the yale keyhole can not be used.



**C54500**  
75x34



**C07820**  
39x152



**C07811 DK**  
30x133

NOVECENTO/XX CENTURY

LINA

C09910





# Mod. LINA

## C09910

Designed by ENRICO CASSINA



**C09910**  
120x244

Privacy  
**C09910/5**  
120x244



**C09911**  
120x45



**C09911/5**  
120x45

Con la rosetta Ø45mm non è possibile utilizzare la molla e il foro cilindro.



With the 45mmØ rose the spring and the yale keyhole can not be used.



**C54500**  
75x34



**C09920**  
36x158



**C09911 DK**  
30x133



**C09950**  
237x45

NOVECENTO/XX CENTURY

LIISI

C12610



# Mod. LIISI

## C12610

Designed by ENRICO CASSINA



### C12610

141x246

### C12614

161x246

Privacy

### C12610/5

141x246

### C12614/5

161x246



### C12611

146x50

### C12615

166x50



### C12611/5

146x50

### C12615/5

166x50



### C54400

81x28



### C12620

38x144



### C12611 DK

30x153

NOVECENTO/XX CENTURY

# MARION

C19310



# Mod. MARION

## C19310

Designed by ENRICO CASSINA



**C19310**  
130x247

Privacy  
**C19310/5**  
130x247



**C19311**  
136x50



**C19311/5**  
136x50



**C54400**  
81x28



**C19311 DK**  
30x143

NOVECENTO/XX CENTURY

JING

C19210



# Mod. JING

## C19210

Designed by ENRICO CASSINA



**C19211**  
122x50



**C19211/5**  
122x50



**C19210**  
116x247

Privacy  
**C19210/5**  
116x247



**C54400**  
81x28



**C19211 DK**  
30x129

NOVECENTO/XX CENTURY

# MELANIE

C13810





# Mod. MELANIE

## C13810

Designed by ENRICO CASSINA



**C13810**  
140x246

Privacy  
**C13810/5**  
140x246



**C13811**  
143x45



**C13811/5**  
143x45

Con la rosetta Ø45mm non è possibile utilizzare la molla e il foro cilindro.



With the 45mmØ rose the spring and the yale keyhole can not be used.



**C55000**  
94x33



**C13820**  
38x145



**C13811 DK**  
30x153



**C13850**  
45x209

NOVECENTO/XX CENTURY

DORA

C16210



# Mod. DORA

## C16210

Designed by ENRICO CASSINA



**C16210**  
122x247

Privacy  
**C16210/5**  
122x247



**C16211**  
124x45



**C16211/5**  
124x45

Con la rosetta Ø45mm non è possibile utilizzare la molla e il foro cilindro.



With the 45mmØ rose the spring and the yale keyhole can not be used.



**C54400**  
81x28



**C16220**  
39x152



**C16211 DK**  
30x134



**C16250**  
45x237

NOVECENTO/XX CENTURY

# ALEKSANDRA

C14210



# Mod. ALEKSANDRA

## C14210

Designed by ENRICO CASSINA



**C14210**  
118x247

Privacy  
**C14210/5**  
118x247



**C14211**  
121x45



**C14211/5**  
121x45

Con la rosetta Ø45mm non è possibile utilizzare la molla e il foro cilindro.

With the 45mmØ rose the spring and the yale keyhole can not be used.



**C54400**  
81x28



**C14220**  
39x152



**C14211 DK**  
30x131



ART  
DÉCO



ART DÉCO

# MARIANNE

C17810





# Mod. MARIANNE

## C17810

Designed by ENRICO CASSINA



**C17810**  
124x290

Privacy  
**C17810/5**  
124x290



**C17820**  
45x160

**C17810DK**  
39x139



**C2780Q**  
60x60xh55

Disponibile  
versione  
girevole **C2780Q**  
(abbinabile con  
bocchetta **CB1860**)  
Revolving version  
available **C2780Q**  
(matching escutcheon  
article **CB1860**)



**C17811**  
124x60

**C17811/5**  
124x60



**C55100**  
75x28

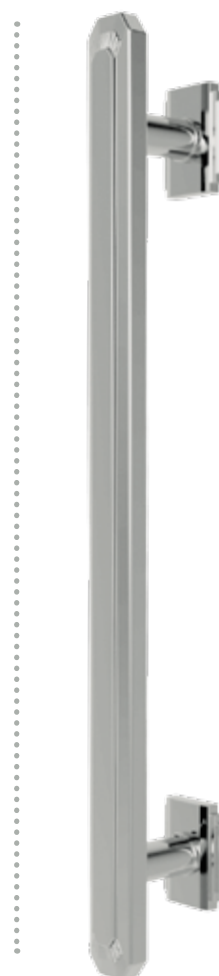

**C47800**  
**400** (45x520)  
**600** (45x720)  
**800** (45x920)

ART DÉCO

# ANNELISE

C09510



# Mod. ANNELISE

## C09510

Designed by ENRICO CASSINA



**C09510**  
133x240

Privacy  
**C09510/5**  
133x240



**C09511**  
132x89



**C09511/5**  
132x89



**C55100**  
75x28



**C09520**  
38x195



**C09511 DK**  
30x145



**C29500**  
50x50xh65

Disponibile  
versione  
girevole **C29500 Q**  
(abbinabile con  
bocchetta **CB2150**)  
Revolving version  
available **C29500 Q**  
(matching escutcheon  
article **CB2150**)



**C09550**  
38x368



**TRENTA**

**THIRTIES**



TRENTA/THIRTIES

MAYA

C02910



Mod. **MAYA**  
**C02910**  
Designed by ENRICO CASSINA



**C02910**  
124x232

Privacy  
**C02910/5**  
124x232



**C02911**  
130x50



**C02911/5**  
130x50



**C55100**  
75x28



**C02920**  
39x152



**C02910 DK**  
39x181



**C02950**  
23x290

Mod. **MAYA**  
**C02910**

Designed by ENRICO CASSINA



**C32200**  
**Asta C319AS non inclusa  
nella confezione**  
Rod C319AS is not  
included in the package

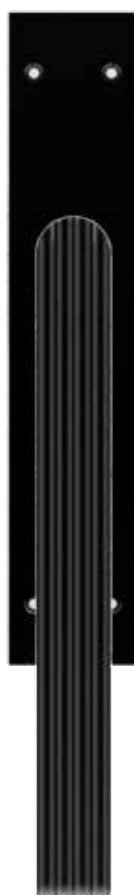

**C02970**  
44x280



**C23100**  
50x50xh59

Disponibile  
versione  
girevole **C23100 Q**  
(abbinabile con  
bocchetta **CB3350**)  
Revolving version  
available **C23100 Q**  
(matching escutcheon  
article **CB3350**)





much  
believe  
her  
tural  
me  
ins  
imals  
ants  
see

plants  
intermediate  
certain  
organic  
vibrantly  
offant  
select  
case  
facts  
nature  
NOW  
birds

TRENTA/THIRTIES

# DOROTEA

C05410



# Mod. DOROTEA

## C05410

Designed by ENRICO CASSINA



**C05410**  
129x232

Privacy  
**C05410/5**  
129x232



**C05411**  
134x50



**C05411/5**  
134x50



**C55100**  
75x28



**C32300**  
**Asta C319AS non inclusa  
nella confezione**  
Rod C319AS is not  
included in the package



**C05450**  
250 (28x271)



**C05470**  
44x228



**C05420**  
39x152



**C05410 DK**  
39x186

TRENTA/THIRTIES

# MARISA

C02411



# Mod. MARISA

## C02411

Designed by ENRICO CASSINA



**C02411**  
133x50



**C02411/5**  
133x50



**C02470**  
44x256



**C55100**  
75x28



**C02420**  
39x145



**C02411 DK**  
30x141

TRENTA/THIRTIES

ELENA

C04411



Mod. ELENA  
**C0441**  
Designed by ENRICO CASSINA



**C0441**  
136x45



**C0441/5**  
136x45



**C55100**  
75x28



**C04420**  
39x145



**C0441 DK**  
35x146

TRENTA/THIRTIES

# CARLA-MARIA

C08211





# Mod. CARLA-MARIA

## C08211

Designed by ENRICO CASSINA

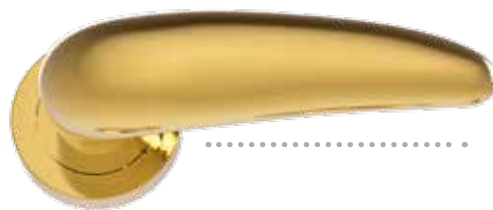

**C08211**  
137x50



**C08211/5**  
137x50



**C54400**  
81x28



**C08270**  
44x229



**C08220**  
39x145



**C08211 DK**  
35x145

TRENTA/THIRTIES

ELVIRA

C09210



# Mod. ELVIRA

## C09210

Designed by ENRICO CASSINA



**C09210**  
87x232

Privacy  
**C09210/5**  
87x232



**C09211**  
91x45



**C09211/5**  
91x45



**C54400**  
81x28



**C09270**  
44x229



**C09220**  
39x152



**C09211 DK**  
30x101

TRENTA/THIRTIES

# TOPAZIA

C09310



# Mod. TOPAZIA

## C09310

Designed by ENRICO CASSINA



**C09310**  
71x232

Privacy  
**C09310/5**  
71x232



**C09311**  
77x50



**C09311/5**  
77x50



**C54400**  
81x28



**C09320**  
39x152



**C09311 DK**  
30x84

TRENTA/THIRTIES

ADA

3000 - 3000 BO



# Mod. ADA

## 3000

Designed by ENRICO CASSINA



**3000**  
82x50



**3000 C**  
82x50



**3000 S**  
82x50



**352**  
Ø50



**C54400**  
81x28



**3000 BO**  
74x62



**3000 BO C**  
74x62



**359 O**  
32x62



**359 C**  
32x62

TRENTA/THIRTIES

ANJA

4801





Mod. ANJA  
**4801**  
Designed by ENRICO CASSINA

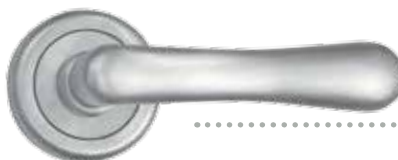

**480190**  
120x50



**480190/5**  
120x50



**C54400**  
81x28



**5700**  
28x88



**4801 DK**  
30x127

A woman wearing a white hijab and sunglasses is driving a classic car. The image is overlaid with a blue tint. The text 'CINQUANTA' is written in white, bold, uppercase letters across the center of the image.

**CINQUANTA**

**FIFTIES**



CINQUANTA/FIFTIES

# WIJDAN

C06611



# Mod. WIJDAN

## C06611

Designed by SERGIO ASTI



**C06611**  
131x45



**C06611/5**  
131x45



**C55100**  
75x28



**C06620**  
39x145

**C06610 DK**  
39x182

CINQUANTA/FIFTIES

ANNA

C06911



Mod. ANNA

**C06911**

Designed by SERGIO ASTI



**C06911**  
125x85



**C06911/5**  
125x85

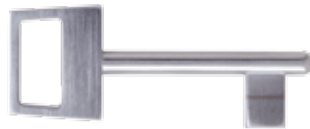

**C55100**  
75x28



**C06620**  
39x145

**C06910 DK**  
39x185

CINQUANTA/FIFTIES

GAE

C06811





# Mod. GAE

## C06811

Designed by ENRICO CASSINA



**C06811**  
135x45



**C06811/5**  
135x45



**C55100**  
28x75



**C06870**  
44x256



**C06820**  
39x145



**C06811 DK**  
30x145



**C06850**  
250 (31x275)

CINQUANTA/FIFTIES

AFRA

C07011



# Mod. AFRA

## C07011

Designed by SERGIO ASTI



**C07011**  
134x45



**C07011/5**  
134x45



**C55100**  
75x28



**C07020**  
39x145

**C07011 DK**  
30x144

CINQUANTA/FIFTIES

HUANG

C07911



# Mod. HUANG

## C07911

Designed by ENRICO CASSINA



**C07911**  
132x45



**C07911/5**  
132x45



**C55100**  
75x28



**C07970**  
44x256



**C07920**  
39x145



**C07911 DK**  
30x142



**C07950**  
250 (25x275)

CINQUANTA/FIFTIES

KAZUYO

4803



Mod. KAZUYO

**4803**

Designed by ENRICO CASSINA



**480390**  
134x50



**480390/5**  
134x50



**C55100**  
75x28



**5701**  
34x70

CINQUANTA/FIFTIES

# ODILE

4807





# Mod. ODILE

## 4807

Designed by ENRICO CASSINA



**480791**  
137x50



**480791/5**  
137x50



**C55100**  
75x28



**4807 DK**  
30x145



**732**  
**250** (30x283)  
**400** (30x430)

# Mod. ODILE

**4807**

Designed by ENRICO CASSINA

ENTRANCE SET

.....



**820057\_AC**  
**820000**  
70x523  
147x340



**820157\_AC**  
**820100**  
70x520  
147x340



**821057\_AC**  
**821000**  
70x523  
70x340



**821157\_AC**  
**821100**  
70x520  
70x340

# Mod. ODILE

## 4807

Designed by ENRICO CASSINA

### INSIDE SET

---



**480792**

145x66

**CPR** - Privacy  
**CPA** - Passage  
**CDU** - Dummy



**485192**

Ø66

**CPR** - Privacy  
**CPA** - Passage  
**CDU** - Dummy

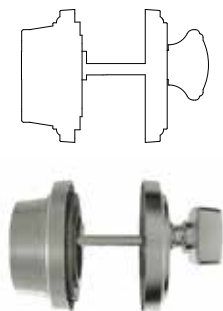

**8200DR**

Ø66

**SC** - Single Cylinder  
**DC** - Double Cylinder

---

### INSIDE SET

---



**8200EP**

147x340

**CPR** - Privacy  
**CPA** - Passage  
**CAC** - Cylinder  
**C5** - Privacy EUROPEAN  
**CPE** - Passage EUROPEAN  
**C2** - Cylinder EUROPEAN



**8210EP**

70x340

**CPR** - Privacy  
**CPA** - Passage  
**CAC** - Cylinder  
**C5** - Privacy EUROPEAN  
**CPE** - Passage EUROPEAN  
**C2** - Cylinder EUROPEAN

---

### MULTIPOINT

---



**480710**

132x240

**C25** - Double Cylinder  
**C05** - Passage  
**C26** - Patio

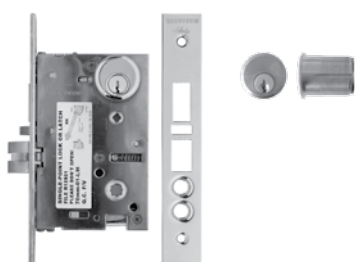

**C400S**

**29**  
**32**  
**35**  
**38**

Disponibile serratura  
Mortise lock available



THE SIGN  
**PROJECT**

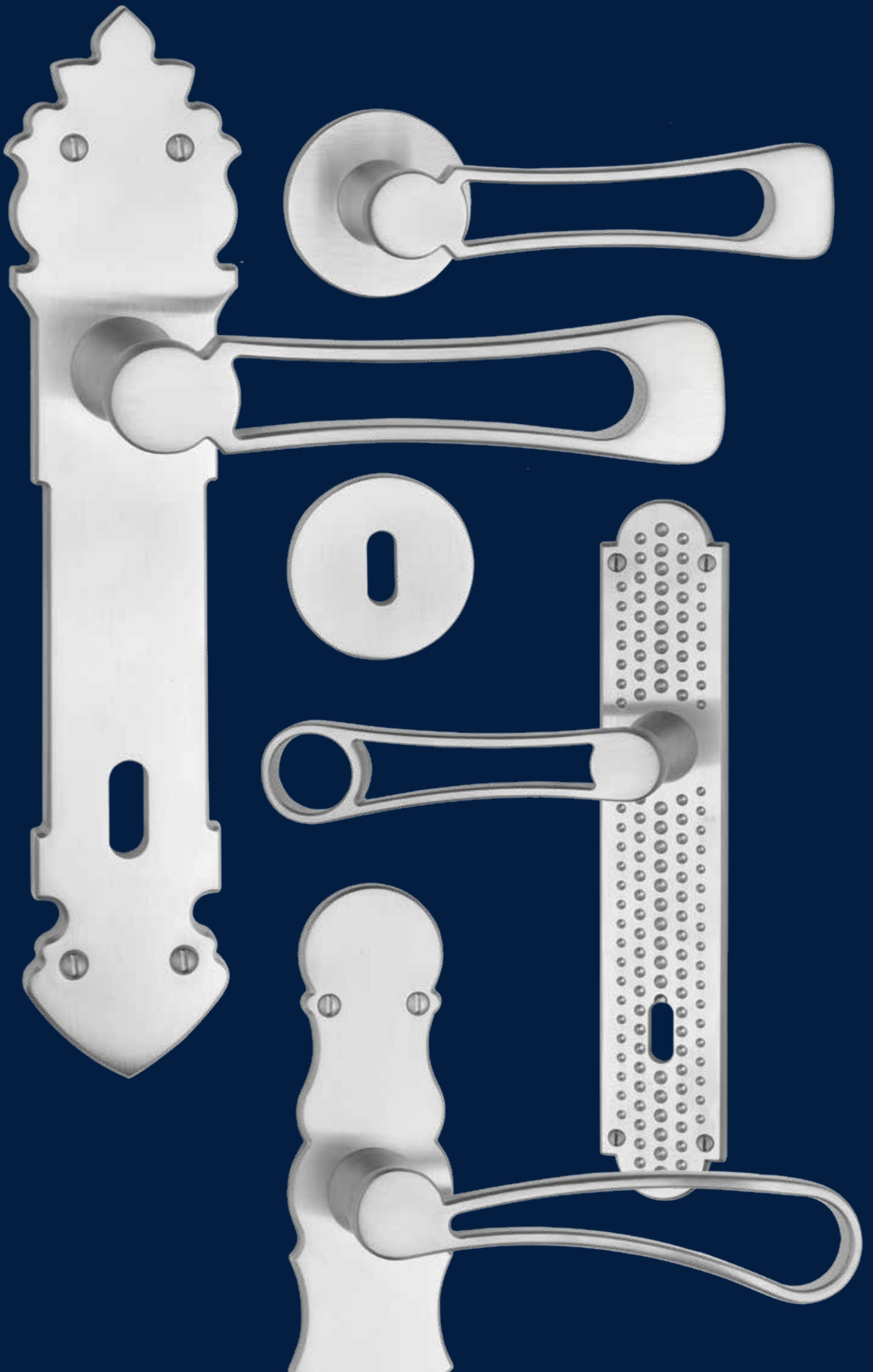

THE SIGN PROJECT

FILOBÌ

C17510



# Mod. FILOBÌ

**C17510**

Designed by MAADE

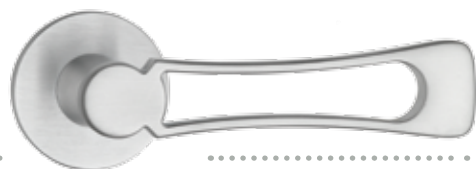

**C17511**  
134x50



**C17511/5**  
134x50



**C17510**  
133x224

Privacy  
**C17510/5**  
133x224



**C54400**  
81x28

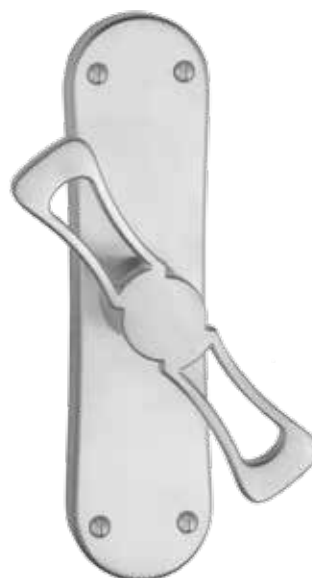

**C17520**  
40x157



**C17510 DK**  
40x188

THE SIGN PROJECT

BARICÒ

C17610





# Mod. BARICÒ

**C17610**

Designed by MAADE

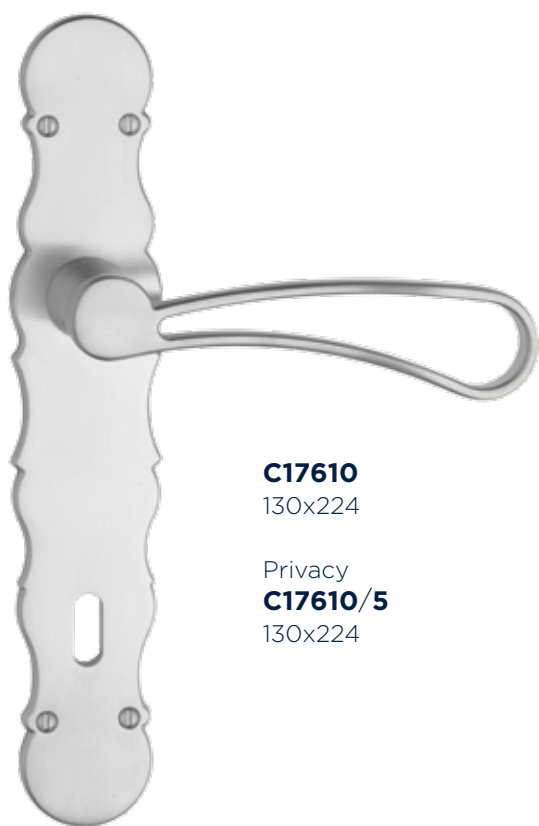

**C17610**  
130x224

Privacy  
**C17610/5**  
130x224



**C17611**  
134x50



**C17611/5**  
134x50



**C54400**  
81x28



**C17620**  
40x157



**C17610 DK**  
40x188

THE SIGN PROJECT

# SOBERAL

C17710



# Mod. SOBERAL

## C17710

Designed by MAADE

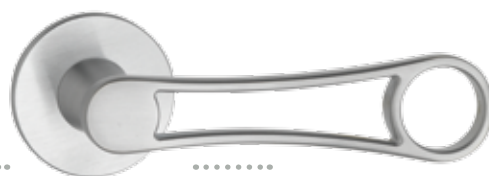

.....

.....



**C17711**  
134x50

**C17711/5**  
134x50



**C17710**  
129x224

Privacy  
**C17710/5**  
129x224



**C54400**  
81x28



**C17720**  
40x157



**C17710 DK**  
40x188



ES!

# ROCO CÒPOP



ROCOCÒPOP

# ROCOCÒPOP

C12810



# Mod. ROCOCÒPOP

**C12810**

Designed by MAADE



**C12810**  
129x248

Privacy  
**C12810/5**  
129x248



**C12811**  
123x80



**C12811/5**  
123x80



**C54600**  
89x33



**CC4x3 BA**  
76x150

**CC4x4 BA**  
102x150

**CC5x4 BA**  
102x175



**C52200**  
41x37



**C12820**  
44x172



**C12810 DK**  
54x165



**POP**  
GUM



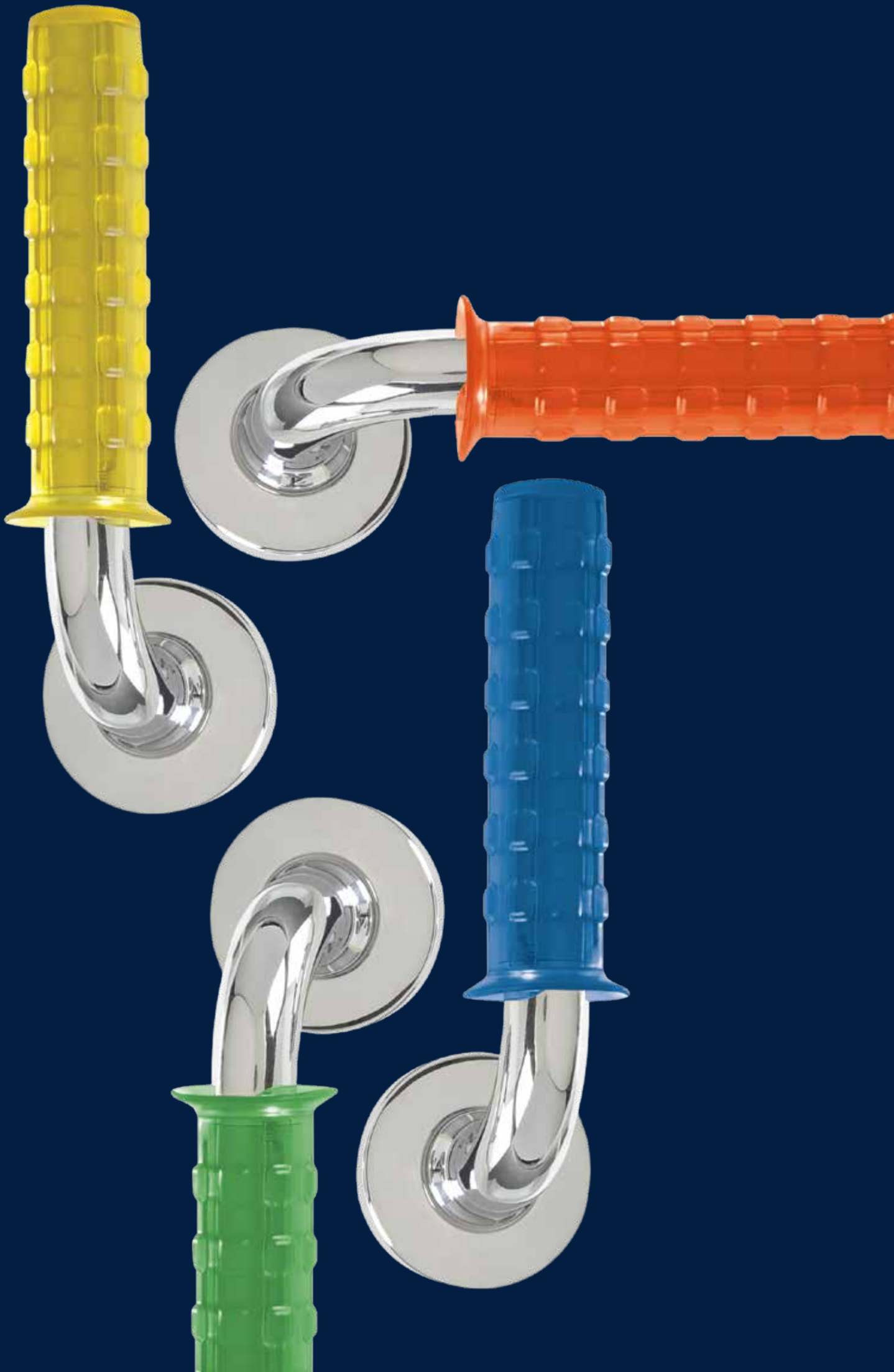

POP GUM

# POP GUM

C19511



# Mod. POP GUM

**C19511**

Designed by LORENZO SUSINI



Blue Gum

**C19511**  
149x47



Gray Gum



**C54400**  
81x28



Orange Gum



Red Gum



Yellow Gum



Green Gum



**C195FP**  
45x30



**C19511 DK**  
30x158



**BAROCCO  
ITALIANO**

ITALIAN  
**BAROQUE**



BAROCCO ITALIANO/ITALIAN BAROQUE

LAVINIA

C12010



Mod. LAVINIA

**C12010**

Designed by ENRICO CASSINA



**C12010**  
145x330

Privacy  
**C12010/5**  
145x330



**C12011**  
133x72



**C12011/5**  
133x72



**C54000**  
87x32



**C12020**  
40x180



**C12010 DK**  
37x175

# Mod. LAVINIA

## C12010

Designed by ENRICO CASSINA

## ENTRANCE SET



**C40010\_AC**

65x450  
145x330



**C40010\_00**

65x450  
145x330



**C60500**

65x450



**C400S**

29  
32  
35  
38

Disponibile serratura  
Mortise lock available





BAROCCO ITALIANO/ITALIAN BAROQUE

# ARTEMISIA

C01910



# Mod. ARTEMISIA

**C01910**

Designed by ENRICO CASSINA



**C01910**  
141x415

Privacy  
**C01910/5**  
141x415



**C12011**  
133x72



**C12011/5**  
133x72



**C54000**  
87x32



**C12020**  
40x180



**C12010 DK**  
37x175

BAROCCO ITALIANO/ITALIAN BAROQUE

# ELISABETTA

C01210



# Mod. ELISABETTA

## C01210

Designed by ENRICO CASSINA



**C01210**  
127x288  
**C01216**  
140x288

Privacy  
**C01210/5**  
127x288  
**C01216/5**  
140x288



**C01215**  
132x82  
**C01217**  
(145x82)



**C04315/5**  
132x82  
**C01217/5**  
(145x82)



**C54000**  
87x32



**C01210 DK**  
38x170

BAROCCO ITALIANO/ITALIAN BAROQUE

# BARBARA

C04312



# Mod. BARBARA

## C04312

Designed by ENRICO CASSINA



**C04312**  
126x276

Privacy  
**C04312/5**  
126x276



**C04315**  
127x89



**C04315/5**  
127x89



**C54200**  
90x27



**C04320**  
41x180



**C04310 DK**  
41x193

# Mod. BARBARA

**C04312**

designed by ENRICO CASSINA



**C31901**

**Asta C319AS non inclusa  
nella confezione**

Rod C319AS is not  
included in the package



**C30200**

**C30225** (Asta/Rod L 250mm)

**C30230** (Asta/Rod L 300mm)

**C30235** (Asta/Rod L 350mm)

**C30240** (Asta/Rod L 400mm)



**C04351**

47x221



**C0889**

47x89







LUIGI  
**XV**

LOUIS  
**XV**



LUIGI XV/LOUIS XV

MARIE

C12810



# Mod. MARIE

## C12810

Designed by ENRICO CASSINA



**C12810**  
129x248

Privacy  
**C12810/5**  
129x248



**C12811**  
123x80



**C12811/5**  
123x80



**C54600**  
89x33



**C12820**  
44x172

**C12810 DK**  
54x165

LUIGI XV/LOUIS XV

# POMPADOUR

C11910



# Mod. POMPADOUR

**C11910**

Designed by ENRICO CASSINA



**C11910**  
124x248

Privacy  
**C11910/5**  
124x248



**C11911**  
118x80



**C11911/5**  
118x80



**C54600**  
89x33



**C11920**  
44x172

**C11910 DK**  
38x159

LUIGI XV/LOUIS XV

DU BARRY

C09110





# Mod. DU BARRY

## C09110

Designed by ENRICO CASSINA



**C09110**  
110x248

Privacy  
**C09110/5**  
110x248



**C09111**  
103x80



**C09111/5**  
103x80



**C54600**  
89x33



**C09120**  
44x172



**C09110 DK**  
36x145

LUIGI XV/LOUIS XV

# ADELAIDE

C06710



# Mod. ADELAIDE

**C06710**

Designed by ENRICO CASSINA



**C06710**

121x277

**C06716**

139x277

Privacy

**C06710/5**

121x277

**C06716/5**

139x277



**C06715**

125x85

**C06717**

144x85



**C06715/5**

125x85

**C06717/5**

144x85



**C54000**

87x32



**C06710 DK**

41x162

An ornate metal gate with a central panel featuring a sun face sculpture. The gate is highly decorative with intricate scrollwork and floral motifs. The background shows a city street with buildings.

LUIGI  
XVI

LOUIS  
XVI



LUIGI XVI/LOUIS XVI

# MARIE-ANTOINETTE

C01610



# Mod. MARIE-ANTOINETTE

**C01610**

Designed by ENRICO CASSINA



**C01610**  
146x507

Privacy  
**C01610/5**  
146x507



**C01615**  
141x75



**C01615/5**  
141x75



**C54600**  
89x33



**C01610 DK**  
36x173

LUIGI XVI/LOUIS XVI

# GABRIELLE

C01810





# Mod. GABRIELLE

**C01810**

Designed by ENRICO CASSINA



**C01810**  
142x358

Privacy  
**C01810/5**  
142x358



**C01615**  
141x75



**C01615/5**  
141x75



**C54600**  
89x33



**C01610 DK**  
36x173

LUIGI XVI/LOUIS XVI

SOFIA

C05110



Mod. SOFIA

**C05110**

Designed by ENRICO CASSINA



**C05110**  
125x278  
**C05116**  
145x278

Privacy  
**C05110/5**  
125x278  
**C05116/5**  
145x278

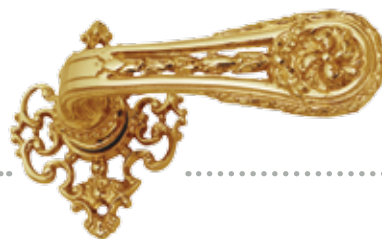

**C05115**  
128x75  
**C05117**  
148x75



**C05115/5**  
128x75  
**C05117/5**  
148x75



**C54600**  
89x33



**C05110 DK**  
36x159



PRIMO  
**IMPERO**

FIRST  
**EMPIRE**



PRIMO IMPERO/FIRST EMPIRE

# GIUSEPPINA

C12512



# Mod. GIUSEPPINA

## C12512

Designed by ENRICO CASSINA



**C12512**  
115x300  
**C12518**  
142x300

Privacy  
**C12512/5**  
115x300  
**C12518/5**  
142x300



**C12511**  
113x46  
**C12517**  
140x46



**C12511/5**  
113x46  
**C12517/5**  
140x46



**C54900**  
88x30



**C12520**  
36x168



**C12510 DK**  
33x140

PRIMO IMPERO/FIRST EMPIRE

# MARIE-LOUISE

C12510





# Mod. MARIE-LOUISE

## C12510

Designed by ENRICO CASSINA



**C12510**  
110x280  
**C12516**  
137x280

Privacy  
**C12510/5**  
110x280  
**C12516/5**  
137x280



**C12511**  
113x46  
**C12517**  
140x46



**C12511/5**  
113x46  
**C12517/5**  
140x46



**C54900**  
88x30



**C12520**  
36x168



**C12510 DK**  
33x140

PRIMO IMPERO/FIRST EMPIRE

ELISA

C11010



# Mod. ELISA

## C11010

Designed by ENRICO CASSINA



**C11010**  
118x280  
**C11016**  
130x280

Privacy  
**C11010/5**  
118x280  
**C11016/5**  
130x280



**C11011**  
120x46  
**C11017**  
130x46



**C11011/5**  
120x46  
**C11017/5**  
130x46



**C54800**  
82x26



**C11020**  
36x168



**C11010 DK**  
33x147

PRIMO IMPERO/FIRST EMPIRE

PAOLINA

C05010



Mod. PAOLINA  
**C05010**

Designed by ENRICO CASSINA



**C05010**  
120x280

Privacy  
**C05010/5**  
120x280



**C05011**  
123x46



**C05011/5**  
123x46



**C54800**  
82x26



**C05010 DK**  
33x150

PRIMO IMPERO/FIRST EMPIRE

LETIZIA

C02010



# Mod. LETIZIA

## C02010

Designed by ENRICO CASSINA



**C02010**  
107x280

Privacy  
**C02010/5**  
107x280



**C02011**  
110x46



**C02011/5**  
110x46



**C54800**  
82x26



**C02020**  
36x168



**C02010 DK**  
33x137

PRIMO IMPERO/FIRST EMPIRE

# CAROLINA

C09010





# Mod. CAROLINA

## C09010

Designed by ENRICO CASSINA



**C09010**  
108x280

Privacy  
**C09010/5**  
108x280



**C09011**  
111x46



**C09011/5**  
111x46



**C54800**  
82x26



**C09020**  
36x168



**C09010 DK**  
33x138

PRIMO IMPERO/FIRST EMPIRE

STEFANIA

C08310



# Mod. STEFANIA

## C08310

Designed by ENRICO CASSINA



**C08310**  
120x280

Privacy  
**C08310/5**  
120x280



**C08311**  
123x46



**C08311/5**  
123x46



**C54700**  
85x30



**C08310 DK**  
33x151

PRIMO IMPERO / FIRST EMPIRE

# ORTENSIA

716



# Mod. ORTENSIA

## 716

Designed by ENRICO CASSINA



**718**  
163x76



**718/5**  
163x76



**C54900**  
88x30



**716**  
167x381

Privacy  
**716/5**  
167x381



**719**  
(76x77)



**715**  
**250** (84x381)

# Mod. ORTENSIA

**716**

Designed by ENRICO CASSINA

ENTRANCE SET

.....



**800057\_AC**  
**800000**  
60x573  
155x381



**800157\_AC**  
**800100**  
60x573  
155x381



**801057\_AC**  
**801000**  
60x573  
60x381



**801157\_AC**  
**801100**  
60x573  
60x381

# Mod. ORTENSIA

## 716

Designed by ENRICO CASSINA

### INTERIOR SET

---



**480892**

158x66

**CPR** - Privacy  
**CPA** - Passage  
**CDU** - Dummy



**485292**

Ø66

**CPR** - Privacy  
**CPA** - Passage  
**CDU** - Dummy

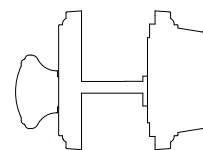

**8300DR**

Ø66

**SC** - Single Cylinder  
**DC** - Double Cylinder

---

### INSIDE SET

---



**8000EP**

155x381

**CPR** - Privacy  
**CPA** - Passage  
**CAC** - Cylinder  
**C5** - Privacy EUROPEAN  
**CPE** - Passage EUROPEAN  
**C2** - Cylinder EUROPEAN



**8010EP**

60x381

**CPR** - Privacy  
**CPA** - Passage  
**CAC** - Cylinder  
**C5** - Privacy EUROPEAN  
**CPE** - Passage EUROPEAN  
**C2** - Cylinder EUROPEAN

---



**C400S**

**29**  
**32**  
**35**  
**38**

Disponibile serratura  
Mortise lock available

PRIMO IMPERO/FIRST EMPIRE

# CARLOTTA

722





# Mod. CARLOTTA

## 722

Designed by ENRICO CASSINA



**722**  
158x429

Privacy  
**722/5**  
158x429



**724**  
157x63



**724/5**  
157x63



**C54900**  
88x30



**721**  
**280** (92x429)



**423**  
**280** (68x368)

The background image shows the interior of a grand, ornate building, likely a government or institutional structure. It features tall, fluted columns with intricate capitals, a large dome with a central fresco, and a series of arches leading to a distant staircase. The lighting is dramatic, highlighting the architectural details. The entire image is overlaid with a dark blue tint.

SECONDO  
**IMPERO**

SECONDO  
**EMPIRE**



SECONDO IMPERO/SECOND EMPIRE

EUGENIE

C08710



# Mod. EUGENIE

## C08710

Designed by ENRICO CASSINA



**C08710**  
120x270

Privacy  
**C08710/5**  
120x270



**C08711**  
118x38



**C08711/5**  
118x38



**C54900**  
88x30



**C08720**  
38x170



**C08710 DK**  
33x149



**C08750**  
38x186

SECONDO IMPERO/SECOND EMPIRE

# ELEONORE

C00710



# Mod. ELEONORE

## C00710

Designed by ENRICO CASSINA



**C00710**  
122x289

Privacy  
**C00710/5**  
122x289



**C00711**  
120x45



**C00711/5**  
120x45



**C54800**  
82x26



**C00710 DK**  
33x148



**C45201**  
45x177

SECONDO IMPERO/SECOND EMPIRE

MATILDE

C13510





# Mod. MATILDE

## C13510

Designed by ENRICO CASSINA



**C13510**  
125x289

Privacy  
**C13510/5**  
125x289



**C13511**  
121x45



**C13511/5**  
121x45



**C54800**  
82x26



**C13510 DK**  
33x149

SECONDO IMPERO/SECOND EMPIRE

# VIRGINIA

C12210



# Mod. VIRGINIA

## C12210

Designed by ENRICO CASSINA



**C12210**  
125x289

Privacy  
**C12210/5**  
125x289



**C12211**  
119x38



**C12211/5**  
119x38



**C54300**  
86x33



**C12210 DK**  
33x150



**C60800**  
73x305



**COLONIALE**

**COLONIAL**

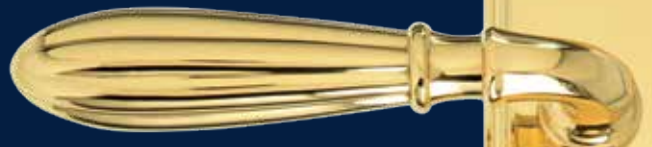

COLONIALE/COLONIAL

# VITTORIA

C12110



# Mod. VITTORIA

## C12110

Designed by ENRICO CASSINA



**C12111**  
156x78



**C12111/5**  
156x78



**C12110**  
143x314

Privacy  
**C12110/5**  
143x314



**C54500**  
75x34



**C49200**  
**400** (69x617)  
**600** (69x817)  
**800** (69x1017)



**C12110 DK**  
35x184

COLONIALE/COLONIAL

# CLEMENTINA

C14010





# Mod. CLEMENTINA

## C14010

Designed by ENRICO CASSINA



**C14010**  
124x246

Privacy  
**C14010/5**  
124x246



**C14011**  
127x45



**C14011/5**  
127x45

Con la rosetta Ø45mm non è possibile utilizzare la molla e il foro cilindro

With the 45mmØ rose, the spring and the yale key hole can not be used.



**C55000**  
94x33



**C14020**  
38x145



**C14011 DK**  
32x137



**C14050**  
45x250

COLONIALE/COLONIAL

# MENEN

C12710



# Mod. MENEN

## C12710

Designed by ENRICO CASSINA



**C12710**  
126x224

Privacy  
**C12710/5**  
126x224



**C12711**  
128x45



**C12711/5**  
128x45



Con la rosetta Ø45mm non è possibile utilizzare la molla e il foro cilindro

With the 45mmØ rose, the spring and the yale key hole can not be used.



**C55000**  
94x33



**C12720**  
39x153



**C12711 DK**  
30x138



**C12750**  
45x173

COLONIALE/COLONIAL

# EMANUELA

4800



# Mod. EMANUELA

## 4800

Designed by ENRICO CASSINA



**480001**  
118x223

Privacy  
**480001/5**  
118x223



**480090**  
124x50



**480090/5**  
124x50



**C54500**  
75x34



**4800 DK**  
30x132

COLONIALE/COLONIAL

INDIRA

4806



# Mod. INDIRA

## 4806

Designed by ENRICO CASSINA

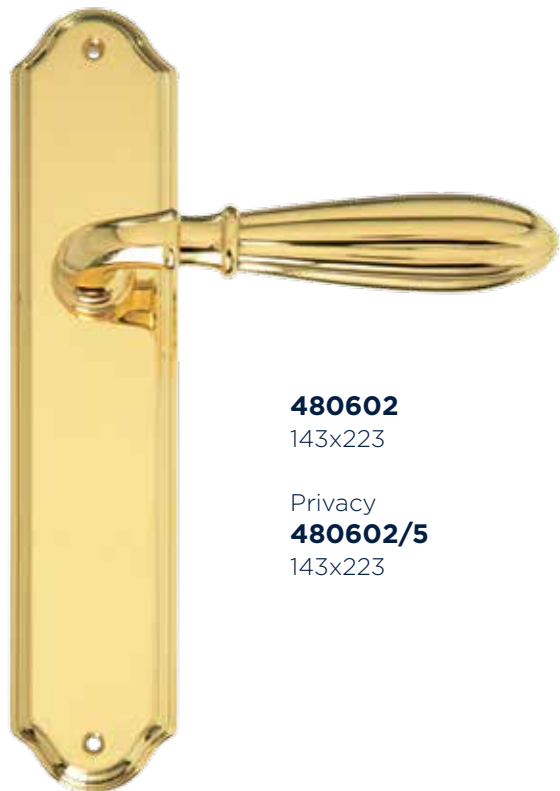

**480602**  
143x223

Privacy  
**480602/5**  
143x223



**480690**  
146x50



**480690/5**  
146x50



**C54500**  
75x34



**4806 DK**  
32x153



**728**  
**235** (53x288)

# Mod. INDIRA

**4806**

Designed by ENRICO CASSINA

ENTRANCE SET

.....



**810057\_AC**  
**810000**  
70x503  
156x340



**810157\_AC**  
**810100**  
70x505  
156x340



**811057\_AC**  
**811000**  
70x503  
70x340



**811157\_AC**  
**811100**  
70x505  
70x340



# Mod. INDIRA

## 4806

Designed by ENRICO CASSINA

### INTERIOR SET



**480692**

154x66

**CPR** - Privacy  
**CPA** - Passage  
**CDU** - Dummy



**485092**

Ø66

**CPR** - Privacy  
**CPA** - Passage  
**CDU** - Dummy

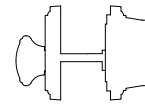

**8100DR**

Ø66

**SC** - Single Cylinder  
**DC** - Double Cylinder

### INSIDE SET



**8100EP**

156x340

**CPR** - Privacy  
**CPA** - Passage  
**CAC** - Cylinder  
**C5** - Privacy EUROPEAN  
**CPE** - Passage EUROPEAN  
**C2** - Cylinder EUROPEAN



**8110EP**

70x340

**CPR** - Privacy  
**CPA** - Passage  
**CAC** - Cylinder  
**C5** - Privacy EUROPEAN  
**CPE** - Passage EUROPEAN  
**C2** - Cylinder EUROPEAN

### MULTIPOINT



**480620**

141x240

**C25** - Double Cylinder  
**C05** - Passage  
**C26** - Patio



**C400S**

**29**  
**32**  
**35**  
**38**

Disponibile serratura  
Mortise lock available



**MURRINA**

**MURANO**  
GLASS



MURRINA/MURANO GLASS

# MURRINA

0169M - 0169MQ



# Mod. MURRINA

**0169M - 0169MQ**

Designed by ENRICO CASSINA



**0169M Q**  
**60** (58x64)  
**70** (68x65)



**0169M**  
**60** (78x66)  
**70** (90x69)



**C54400**  
81x28



**352**  
Ø50



**354**  
Ø50



**354 C**  
Ø50



**354 S**  
Ø50



**354 O**  
Ø50



**MOSAICO**

**MOSAIC**



MOSAICO/MOSAIC

MOSAICO\*

C471 - C472 - C473





Mod. MOSAICO\*

**C471 - C472 - C473**

Designed by ENRICO CASSINA



**VILLA OLMO**  
**C471**  
160x350



**VILLA CARLOTTA**  
**C472**  
127x320



**VILLA ERBA**  
**C473**  
102x536

\*con foglia d'oro  
\*with gold leaf

**MADREPERLA**

**MOTHER OF PEARL**



MADREPERLA/MOTHER OF PEARL

# MADREPERLA

C03010



# Mod. MADREPERLA

## C03010

Designed by ENRICO CASSINA



**C03010**

152x300

Privacy

**C03010/5**

152x300



**C03011**

154x58



**C03011/5**

154x58



**C54400**

81x28



**C03011 DK**

43x158



**C23000**

Ø81xh65



**C23000 Q**

Ø81xh65

Rosetta/Rose

Ø58



**CB3060**

Ø58



**C03050**

58x310



**CRISTALLI**

MADE WITH SWAROVSKI® ELEMENTS

**CRYSTALS**

MADE WITH SWAROVSKI® ELEMENTS

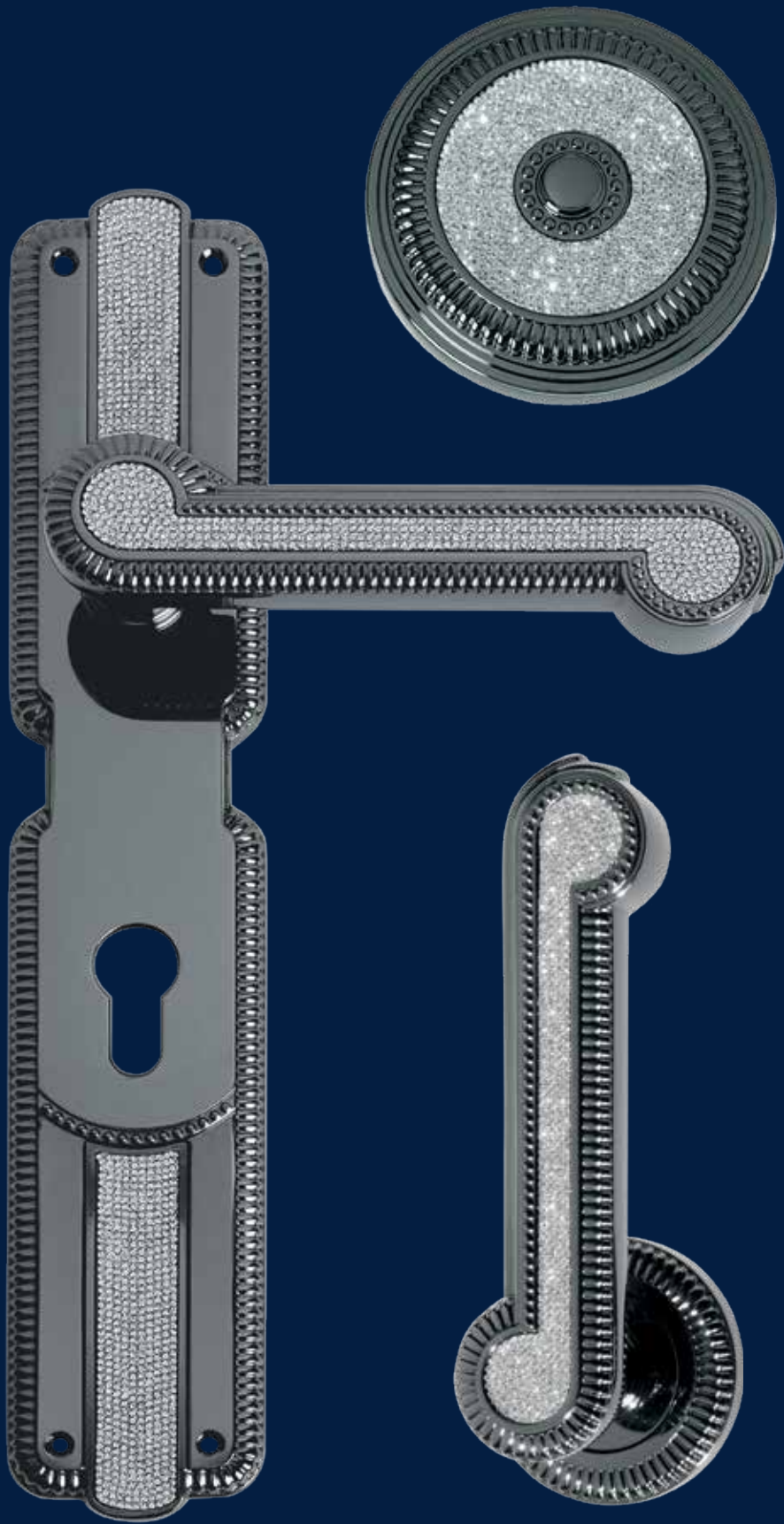

CRISTALLI/CRYSTALS

CRISTALLI\*

C03010 SW





# Mod. CRISTALLI\*

## C03010 SW

Designed by ENRICO CASSINA

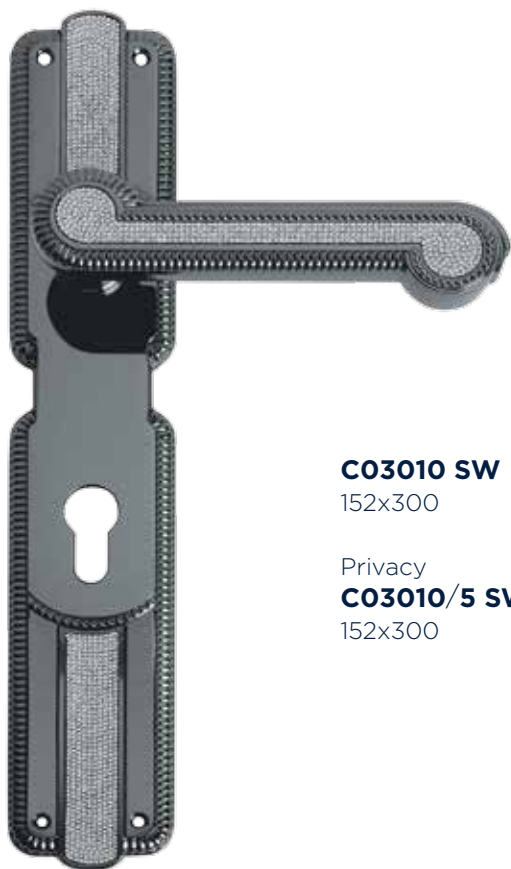

**C03010 SW**

152x300

Privacy

**C03010/5 SW**

152x300

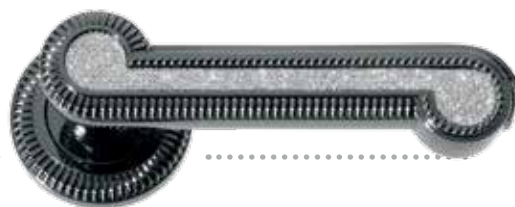

**C03011 SW**

154x58



**C03011/5 SW**

154x58



**C54400**

81x28



**C03011 DK SW**

43x158



**C23000 SW**

Ø81xh65



**C23000 Q SW**

Ø81xh65

Rosetta/Rose Ø58



**CB3060**

Ø58



**C03050 SW**

58x310

\*MADE WITH SWAROVSKI® ELEMENTS



SERVIZIO  
PERSONALIZZATO

BESPOKE  
SERVICE

## SU MISURA

Per chi non vuole rinunciare alla purezza dello stile ma ha necessità particolari tutte le Maniglie Enrico Cassina possono essere personalizzate.

Una personalizzazione dimensionale, per rendere la maniglia ergonomicamente adatta al singolo Cliente ma anche, quando necessario, per adattarla alle dimensioni particolari di portali o finestratezze mantenendo equilibrata l'immagine d'insieme.

Come tutti i prodotti Officine Meccaniche Porro anche le maniglie Enrico Cassina possono avere, oltre alle finiture da noi consigliate, la finitura che più soddisfa il gusto di ogni nostro Cliente.

## CUSTOMIZED

The Enrico Cassina handles can be customized for those who do not want to give up purity of style, but have special requirements to meet.

We can customize sizes to ergonomically adjust the handle to the customer's own specifications, and, when necessary, to the special measurements of windows and doors, while also maintaining all proportions in equilibrium.

Like all Officine Meccaniche Porro products, Enrico Cassina handles can feature either our standard finishes or those requested by our clients.

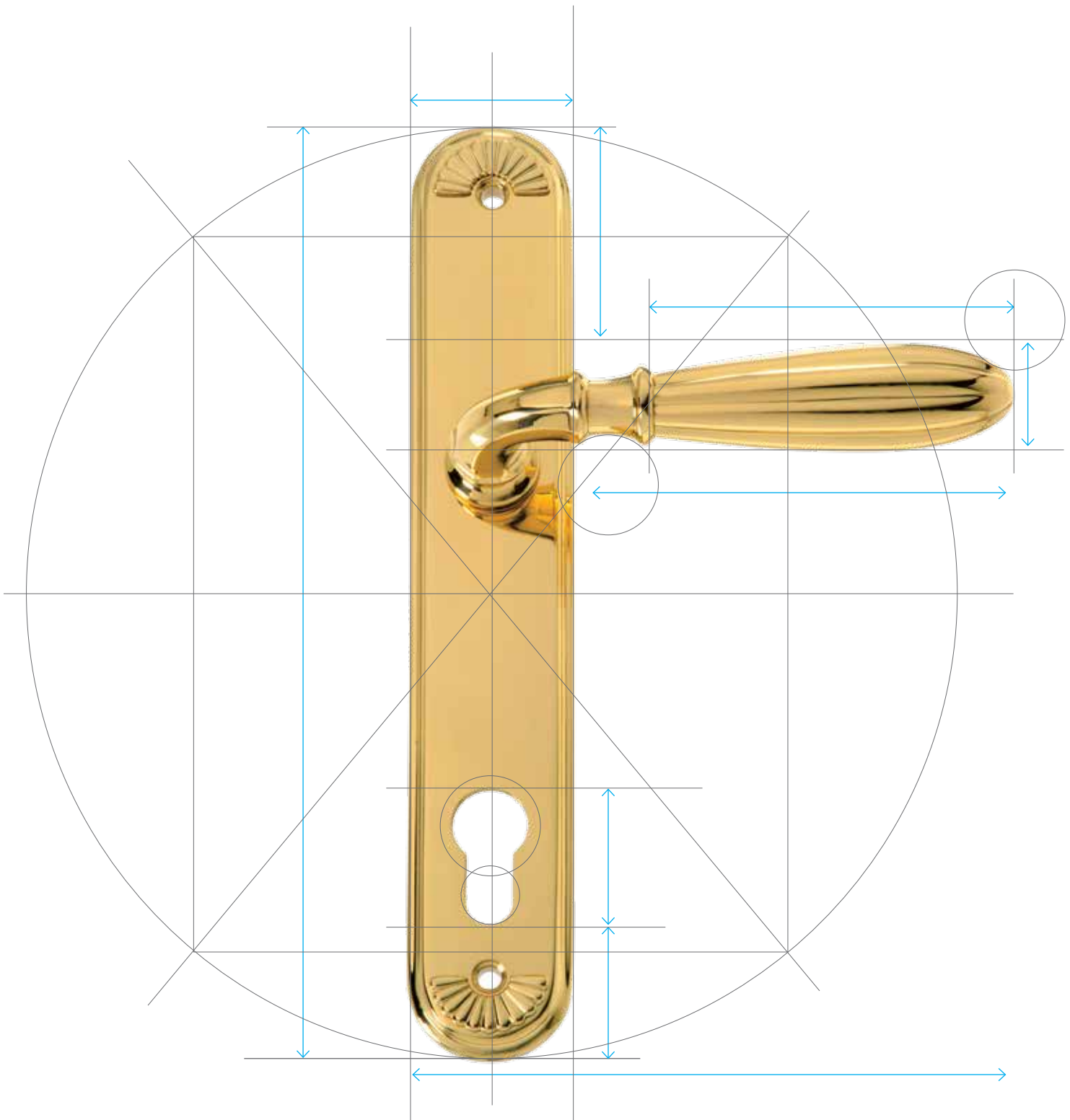



**ACCESSORI**  
PORTA

DOOR  
**ACCESSORIES**



MANIGLIONI  
PULL HANDLES

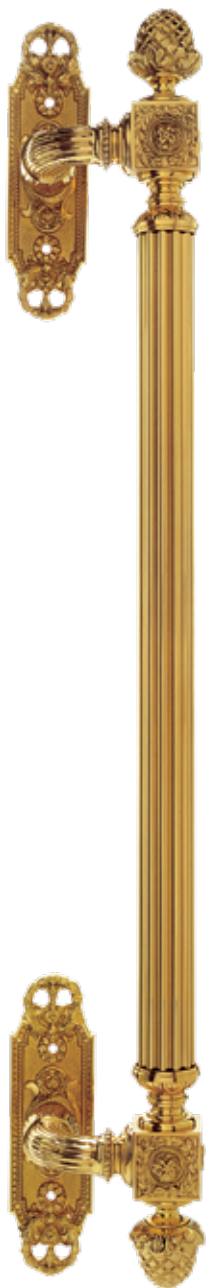

**C49000**  
600 (122x788)  
800 (122x988)  
1000 (122x1188)

PRIMO IMPERO  
FIRST EMPIRE



**CB2400**  
54x188



**C48600**  
600 (125x820)  
800 (125x1020)  
1000 (125x1220)



**CB2770**  
Ø70

SECONDO IMPERO  
SECOND EMPIRE



**C49100**  
600 (123x880)  
800 (123x1080)  
1000 (123x1280)



**CB2290**  
90x90

BAROCCO ITALIANO  
LUIGI XV  
LUIGI XVI  
ITALIAN BAROQUE  
LOUIS XV  
LOUIS XVI

MANIGLIONI  
 .....  
 PULL HANDLES



**C49200**  
**400** (69x617)  
**600** (69x817)  
**800** (69x1017)



**CB1678**  
 78x78

COLONIALE  
 COLONIAL

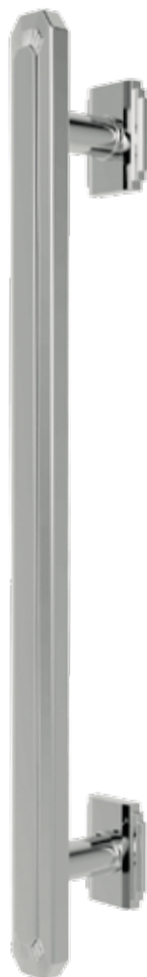

**C47800**  
**400** (45x520)  
**600** (45x720)  
**800** (45x920)



**CB1860**  
 45x60

ART DÉCO

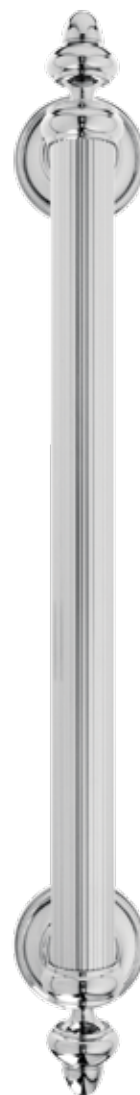

**C48800**  
**400** (68x513)  
**600** (68x713)  
**800** (68x913)



**CB1968**  
 Ø68

NOVECENTO  
 XX CENTURY

# MANIGLIONI

## PULL HANDLES



**709 R**  
**250** (84x303)  
**500** (84x553)

NOVECENTO  
XX CENTURY



**709**  
**250** (84x303)  
**500** (84x553)

NOVECENTO  
XX CENTURY



**713**  
**250** (85x304)  
**500** (99x554)



**705**  
**235** (70x244)  
**400** (73x460)

COLONIALE  
COLONIAL



MANIGLIONI  
PULL HANDLES



**732**  
**250** (30x283)  
**400** (30x430)

CINQUANTA  
FIFTIES



**C09550**  
38x368



**CB1489**  
38x89

ART DÉCO



**C09450**  
48x333



**CB1384**  
44x84

ART NOUVEAU



**C02950**  
23x290



**CB3350**  
50x50

TRENTA  
THIRTIES

MANIGLIONI  
PULL HANDLES



**C42700**  
87x460

SECONDO IMPERO  
SECOND EMPIRE



**721**  
**280** (92x429)

PRIMO IMPERO  
FIRST EMPIRE



**715**  
**250** (84x381)

PRIMO IMPERO  
FIRST EMPIRE



**C09650**  
48x360

ART NOUVEAU

MANIGLIONI  
PULL HANDLES



**423**  
**280** (68x368)

PRIMO IMPERO  
FIRST EMPIRE



**C42200**  
64x332

PRIMO IMPERO  
FIRST EMPIRE



**C42400**  
67x288

PRIMO IMPERO  
FIRST EMPIRE



**C14050**  
45x250



**CB2045**  
Ø45

COLONIALE  
COLONIAL

MANIGLIONI  
PULL HANDLES



**711**  
**200** (53x254)  
**300** (75x375)

COLONIALE  
NOVECENTO  
COLONIAL  
XX CENTURY



**728**  
**235** (53x288)

COLONIALE  
COLONIAL



**706**  
**280** (73x278)

COLONIALE  
COLONIAL



**706 O**  
**280** (54x278)

COLONIALE  
COLONIAL

MANIGLIONI  
PULL HANDLES



**C13050**  
45x275



**CB2045**  
Ø45

NOVECENTO  
XX CENTURY



**C10150**  
58x272



**CB1558**  
58x58

NOVECENTO  
XX CENTURY



**C06850**  
250 (31x275)



**CB0945**  
Ø45

CINQUANTA  
FIFTIES



**C07950**  
250 (25x275)



**CB0945**  
Ø45

CINQUANTA  
FIFTIES

MANIGLIONI  
PULL HANDLES



**C05450**  
**250** (28x271)



**CB3350**  
50x50

TRENTA  
THIRTIES



**714**  
**200** (50x265)

**714 D**  
**128** (43x170)



**C17350**  
45x251



**CB2045**  
Ø45

NOVECENTO  
XX CENTURY



**710**  
**200** (60x250)

TRENTA  
THIRTIES

MANIGLIONI  
PULL HANDLES



**C09950**  
192 (45x237)



**C16250**  
45x237



**C43600**  
45x223



**C13850**  
45x209



**CB2045**  
Ø45

NOVECENTO  
XX CENTURY



**CB2045**  
Ø45

NOVECENTO  
XX CENTURY



**CB2045**  
Ø45

NOVECENTO  
XX CENTURY



**CB2045**  
Ø45

NOVECENTO  
XX CENTURY

# MANIGLIONI PULL HANDLES



**CB0538**  
Ø38



**C08750**  
38x186

SECONDO IMPERO  
SECOND EMPIRE



**CB0445**  
Ø45



**C45201**  
45x177

SECONDO IMPERO  
SECOND EMPIRE



**C12750**  
45x173



**CB0889**  
47x89



**C04351**  
47x221

BAROCCO ITALIANO  
ITALIAN BAROQUE



**CB0345**  
Ø46



**C44900**  
46x191

PRIMO IMPERO  
FIRST EMPIRE



**CB2045**  
Ø45

COLONIALE  
COLONIAL



MANIGLIONI  
PULL HANDLES



**VILLA ERBA\***  
**C473**  
102x536

MOSAICO  
MOSAIC

\*con foglia d'oro  
\*with gold leaf



**VILLA CARLOTTA\***  
**C472**

127x320

MOSAICO  
MOSAIC



**VILLA OLMO\***  
**C471**

160x350

MOSAICO  
MOSAIC



**C03050 SW\*\***

58x310

CRISTALLI  
CRYSTALS



**CB3060**

Ø58

CRISTALLI  
CRYSTALS  
MADREPERLA  
MOTHER OF PEARL



**C03050**

58x310

MADREPERLA  
MOTHER OF PEARL

\*\*MADE WITH SWAROVSKI® ELEMENTS

MANIGLIONI AMERICANI  
ENTRANCE SET



**C40010\_AC**

65x450  
145x330

**C40010\_00**

65x450  
145x330

BAROCCO ITALIANO  
ITALIAN BAROQUE

# MANIGLIONI AMERICANI

## ENTRANCE SET



**800057\_AC**  
**800000**  
60x573  
155x381



**800157\_AC**  
**800100**  
60x573  
155x381



**801057\_AC**  
**801000**  
60x573  
60x381



**801157\_AC**  
**801100**  
60x573  
60x381

PRIMO IMPERO  
FIRST EMPIRE

MANIGLIONI AMERICANI  
 ENTRANCE SET



**810057\_AC**  
**810000**  
 70x503  
 156x340



**810157\_AC**  
**810100**  
 70x505  
 156x340



**811057\_AC**  
**811000**  
 70x503  
 70x340



**811157\_AC**  
**811100**  
 70x505  
 70x340

COLONIALE  
 COLONIAL

MANIGLIONI AMERICANI  
ENTRANCE SET



**830057\_AC**  
**830000**  
70x503  
155x340



**830157\_AC**  
**830100**  
70x495  
155x340



**831057\_AC**  
**831000**  
70x503  
70x340



**831157\_AC**  
**831100**  
70x495  
70x340

MANIGLIONI AMERICANI  
ENTRANCE SET



**C41000\_AC**  
70x523  
70x143



**C41000\_00**  
70x523  
70x143

NOVECEN  
XX CENTURY

# MANIGLIONI AMERICANI

## ENTRANCE SET



**820057\_AC**  
**820000**  
70x523  
147x340



**820157\_AC**  
**820100**  
70x520  
147x340



**821057\_AC**  
**821000**  
70x523  
70x340



**821157\_AC**  
**821100**  
70x520  
70x340

CINQUANTA  
FIFTIES

BATTENTI  
DOOR KNOCKERS



**701**  
**100** (100x127)  
**125** (123x158)  
**150** (149x194)

COLONIALE  
COLONIAL



**645**  
**110** (110x208)  
**150** (155x290)

PRIMO IMPERO  
FIRST EMPIRE



**700**  
**100** (100x128)  
**125** (125x153)  
**150** (150x192)

COLONIALE  
COLONIAL



BATTENTI  
DOOR KNOCKERS



**702**  
**100** (89x130)  
**125** (112x158)  
**150** (133x192)

NOVECENTO  
XX CENTURY



**703**  
**125** (117x161)  
**150** (137x191)

COLONIALE  
COLONIAL

MANIGLIE INCASSO  
FLUSH HANDLES



**C50500**  
41x116

**C50500 FC**  
41x116

BAROCCO ITALIANO  
LUIGI XV  
LUIGI XVI  
ITALIAN BAROQUE  
LOUIS XV  
LOUIS XVI



**C50700**  
Ø64



**C507AC**  
Ø64

BAROCCO ITALIANO  
LUIGI XV  
LUIGI XVI  
ITALIAN BAROQUE  
LOUIS XV  
LOUIS XVI



**C50900**  
37x164

**C50900 FC**  
37x164

SECONDO IMPERO  
SECOND EMPIRE



**C50400**  
43x108

**C50400 FC**  
43x108

BAROCCO ITALIANO  
ITALIAN BAROQUE

# MANIGLIE INCASSO

## FLUSH HANDLES



**C50300**  
Ø64



**C503 AC**  
Ø64



**C50100**  
35x169



**C50100 FC**  
35x169

PRIMO IMPERO  
FIRST EMPIRE

PRIMO IMPERO  
FIRST EMPIRE



**C50800**  
35x119



**C50800 FC**  
35x119



**C51000**  
37x121



**C51000 FC**  
37x121

SECONDO IMPERO  
SECOND EMPIRE

NOVECENTO  
XX CENTURY

PLACCHE PUSH-PULL  
.....  
PUSH PLATES



**C60500**  
65x450

BAROCCO ITALIANO  
ITALIAN BAROQUE



**C60400**  
88X380

BAROCCO ITALIANO  
ITALIAN BAROQUE



**C60800**  
73x305

SECONDO IMPERO  
SECOND EMPIRE



**C61100**  
76x187

PRIMO IMPERO  
FIRST EMPIRE

POMOLI CENTROPORTA  
DOOR KNOBS



**C29900**  
Ø200

PRIMO IMPERO  
FIRST EMPIRE



**C29800**  
Ø200

NOVECENTO  
XX CENTURY

POMOLI PORTA  
DOOR KNOBS



**C22401 Q**  
45x85



**C22401**  
45x85



**C21200 Q**  
Ø60



**C21200**  
Ø60



**CB1085**  
45x85

LUIGI XV  
LOUIS XV



**CB2360**  
Ø60

LUIGI XVI  
SECONDO IMPERO  
LOUIS XVI  
SECOND EMPIRE



**135**  
**60** (60xh45)  
**75** (75xh56)

LUIGI XV  
COLONIALE  
LOUIS XV  
COLONIAL



**C22900 Q**  
46x65xh56



**C22900**  
46x65xh56



**CB0345**  
Ø46

PRIMO IMPERO  
FIRST EMPIRE

POMOLI PORTA  
DOOR KNOBS



**C25500**  
Ø80



**C25500 Q**  
Ø80



**CB2580**  
Ø80

PRIMO IMPERO  
FIRST EMPIRE



**C21100**  
Ø62



**C21100 Q**  
Ø62



**CB2855**  
Ø55

PRIMO IMPERO  
FIRST EMPIRE



**C21102**  
Ø130

PRIMO IMPERO  
FIRST EMPIRE



**C21101**  
76x187xh44

PRIMO IMPERO  
FIRST EMPIRE

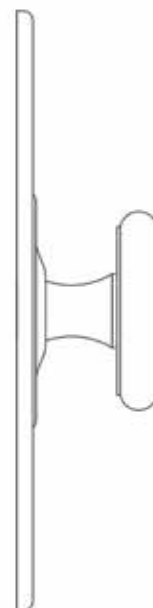

POMOLI PORTA  
DOOR KNOBS



**719**  
76x77xh59

PRIMO IMPERO  
FIRST EMPIRE



**C25800**  
42x89



**C21800**  
51x95



**C21800 Q**  
51x95



**CB0345**  
Ø46



**C25800 Q**  
42x89

PRIMO IMPERO  
FIRST EMPIRE



**C25901**  
46x75xh53



**C25901 Q**  
46x75xh53



**CB0345**  
Ø46



**CB2689**  
42x89

PRIMO IMPERO  
FIRST EMPIRE

PRIMO IMPERO  
FIRST EMPIRE



POMOLI PORTA  
DOOR KNOBS



**C24400**  
Ø100



**C24400 Q**  
Ø100



**CB2770**  
Ø70

PRIMO IMPERO  
FIRST EMPIRE



**C24401**  
Ø70



**C24401 Q**  
Ø70



**CB2770**  
Ø70

PRIMO IMPERO  
FIRST EMPIRE



**C21500**  
Ø55x77xh49



**C21500 Q**  
Ø55x77xh49



**CB2855**  
Ø55

SECONDO IMPERO  
SECOND EMPIRE

POMOLI PORTA  
DOOR KNOBS



**C21301**  
Ø55xh48



**C21301 Q**  
Ø55xh48



**CB2855**  
Ø55

SECONDO IMPERO  
SECOND EMPIRE

---



**C24100**  
38x69xh50



**C24100 Q**  
38x69xh50



**CB0538**  
Ø38

SECONDO IMPERO  
SECOND EMPIRE

---



**C21300**  
Ø100xh57



**C21300 Q**  
Ø100xh57



**CB2770**  
Ø70

SECONDO IMPERO  
SECOND EMPIRE

POMOLI PORTA  
DOOR KNOBS



**170**  
**55** (Ø55x55)



**170 Q**  
**55** (Ø55x65)



**352**  
Ø50

COLONIALE  
NOVECENTO  
COLONIAL  
XX CENTURY



**354 C**  
Ø50



**354 S**  
Ø50



**354 O**  
Ø50



**354**  
Ø50

COLONIALE  
NOVECENTO  
COLONIAL  
XX CENTURY

POMOLI PORTA  
 .....  
 DOOR KNOBS



**168 Q**  
**70** (68x79)



**355**  
 Ø54



**355 C**  
 Ø54



**355 S**  
 Ø54



**355 O**  
 Ø54

COLONIALE  
 COLONIAL



**C29400**  
 48x118



**C29400 Q**  
 48x118



**CB1384**  
 44x84



**168**  
**70** (87x82)  
**85** (98x94)

ART NOUVEAU

COLONIALE  
 COLONIAL

# POMOLI PORTA

---

## DOOR KNOBS



**169**  
**60** (78x67)  
**70** (90x70)  
**90** (90x74)

### NOVECENTO XX CENTURY

---



**169Q**  
**60** (58x65)  
**70** (68x66)



**354**  
Ø50



**354 C**  
Ø50



**354 S**  
Ø50



**354 O**  
Ø50



**352**  
Ø50

### NOVECENTO XX CENTURY

POMOLI PORTA  
DOOR KNOBS



**C20400**  
70xh61



**C20400 Q**  
70xh61



**CB2770**  
Ø70

NOVECENTO  
XX CENTURY



**C20100**  
58x58xh64



**C20100 Q**  
58x58xh64



**CB1558**  
58x58

NOVECENTO  
XX CENTURY



**C24600**  
Ø65xh50



**C24600 Q**  
Ø65xh50



**CB2965**  
Ø65

NOVECENTO  
XX CENTURY

POMOLI PORTA  
DOOR KNOBS



**C27800 Q**  
60x60xh55



**C27800**  
60x60xh55



**C23100 Q**  
50x50xh59



**C23100**  
50x50xh59



**CB1860**  
45x60

ART DÉCO



**CB3350**  
50x50

TRENTA  
THIRTIES



**C29500 Q**  
50xh65



**C29500**  
50xh65



**CB2150**  
Ø50

ART DÉCO



**181**  
**50** (50x55)  
**70** (74x70)

TRENTA  
CINQUANTA  
THIRTIES  
FIFTIES

POMOLI PORTA  
DOOR KNOBS



**C23000 SW\***  
Ø81xh65



**C23000**  
Ø81xh65



**C23000 Q SW\***  
Ø81xh65  
Rosetta/Rose Ø58



**C23000 Q**  
Ø81xh65  
Rosetta/Rose  
Ø58



**CB3060**  
Ø58



**CB3060**  
Ø58

MATERIE PREZIOSE  
PRECIOUS MATERIALS

MATERIE PREZIOSE  
PRECIOUS MATERIALS

\*MADE WITH SWAROVSKI® ELEMENTS



CERNIERE  
DOOR HINGES



**CC5x4 BA**  
102x175



**CC4x4 BA**  
102x150



**CC4x3 BA**  
76x150

BAROCCO ITALIANO  
LUIGI XV  
LUIGI XVI  
ITALIAN BAROQUE  
LOUIS XV  
LOUIS XVI



**CC5x4 IM**  
102x171



**CC4x4 IM**  
102x146



**CC4x3 IM**  
76x146

PRIMO IMPERO  
FIRST EMPIRE

## COPRI CERNIERE

.....

### HINGE COVERS



**1121**

**Ø14** (16x37)

**Ø14** (16x58)

**Ø16** (18x37)

**Ø16** (18x58)



**1120**

**Ø14** (16x53)

**Ø14** (16x74)

**Ø16** (18x53)

**Ø16** (18x74)

## FINALI\*

.....

### END-KNOBS\*



**CCF16A**

19x17



**CCF16D**

16x16



**CCF16B**

16x17



**CCF16E**

18x14



**CCF16G**

16x9



**CCF16C**

16x15



**CCF16F**

16x5

\*Applicabili alle nostre cerniere: CC1110 - CC2110 - CC1010 - CC2010

\*Suitable for our door hinges: CC1110 - CC2110 - CC1010 - CC2010

CERNIERE  
DOOR HINGES



**CC1110**  
75x120



**CC2110**  
61x120



**CC1010**  
75x120



**CC2010**  
61x120

FERMAPORTE  
 .....  
 DOOR STOPS



**C52200**  
 41x37

BAROCCO ITALIANO  
 LUIGI XV  
 LUIGI XVI  
 ITALIAN BAROQUE  
 LOUIS XV  
 LOUIS XVI



**C52100**  
 41x41

IMPERO  
 EMPIRE



**C52000**  
 41x42

COLONIALE  
 NOVECENTO  
 COLONIAL  
 XX CENTURY



Disponibile versione gommino colorata:  
 Available with coloured rubber:



**1307**  
 33x34

NOVECENTO  
 ART DÉCO  
 THE SIGN PROJECT  
 XX CENTURY

**1305**  
 45x30

COLONIALE  
 ART NOUVEAU  
 NOVECENTO  
 TRENTA  
 COLONIAL  
 XX CENTURY  
 THIRTIES



**1147**  
 22x78

NOVECENTO  
 XX CENTURY



**1148**  
 32x95

NOVECENTO  
 XX CENTURY

# CARIGLIONI E CATENACCI

---

## CREMONE BOLTS AND SLIDING BOLTS

### **C31901**

**Asta C319AS non inclusa  
nella confezione**

Rod C319AS is not  
included in the package



### **C30200**

**C30225** (Asta/Rod L 250mm)

**C30230** (Asta/Rod L 300mm)

**C30235** (Asta/Rod L 350mm)

**C30240** (Asta/Rod L 400mm)

**BAROCCO ITALIANO**  
**ITALIAN BAROQUE**



### **C32000**

**Asta C319AS non inclusa  
nella confezione**

Rod C319AS is not  
included in the package



### **C30400**

**25** (Asta/Rod L 250 mm)

**30** (Asta/Rod L 300 mm)

**35** (Asta/Rod L 350 mm)

**40** (Asta/Rod L 400 mm)

**LUIGI XV**  
**LOUIS XV**



# CARIGLIONI E CATENACCI

---

## CREMONE BOLTS AND SLIDING BOLTS



### C32900

**Asta C319AS non inclusa  
nella confezione**

Rod C319AS is not  
included in the package

PRIMO IMPERO  
FIRST EMPIRE



### C30100

**25** (Asta/Rod L 250 mm)

**30** (Asta/Rod L 300 mm)

**35** (Asta/Rod L 350 mm)

**40** (Asta/Rod L 400 mm)



### C32901

**Asta C319AS non inclusa  
nella confezione**

Rod C319AS is not  
included in the package

PRIMO IMPERO  
FIRST EMPIRE

# CARIGLIONI E CATENACCI

---

## CREMONE BOLTS AND SLIDING BOLTS



**C30300**  
25 (Asta/Rod L 250mm)  
30 (Asta/Rod L 300mm)  
35 (Asta/Rod L 350mm)  
40 (Asta/Rod L 400mm)



**C35900**  
**Asta C319AS non inclusa  
nella confezione**  
Rod C319AS is not  
included in the package

SECONDO IMPERO  
SECOND EMPIRE



**C35901**  
**Asta C319AS non inclusa  
nella confezione**  
Rod C319AS is not  
included in the package

SECONDO IMPERO  
SECOND EMPIRE

# CARIGLIONI E CATENACCI

---

## CREMONE BOLTS AND SLIDING BOLTS



**C35902**  
**Asta C319AS non inclusa  
nella confezione**  
Rod C319AS is not  
included in the package

SECONDO IMPERO  
SECOND EMPIRE

**C32100**  
**Asta C319AS non inclusa  
nella confezione**  
Rod C319AS is not  
included in the package



**C30500**  
**25** (Asta/Rod L 250 mm)  
**30** (Asta/Rod L 300 mm)  
**35** (Asta/Rod L 350 mm)  
**40** (Asta/Rod L 400 mm)

NOVECENTO  
XX CENTURY



CARIGLIONI E CATENACCI  
CREMONE BOLTS AND SLIDING BOLTS



**C32200**  
**Asta C319AS non inclusa  
nella confezione**  
Rod C319AS is not  
included in the package

TRENTA  
THIRTIES



**C32300**  
**Asta C319AS non inclusa  
nella confezione**  
Rod C319AS is not  
included in the package

TRENTA  
THIRTIES

ALZANTI SCORREVOLI  
TILT AND SLIDE PATIO HANDLES



**C13070**  
44x242

NOVECENTO  
XX CENTURY



**C17370**  
44x265

NOVECENTO  
XX CENTURY



**C15170**  
44x267

NOVECENTO  
XX CENTURY



**C10170**  
50x229

NOVECENTO  
XX CENTURY

ALZANTI SCORREVOLI  
TILT AND SLIDE PATIO HANDLES



**C02970**  
44x280

TRENTA  
THIRTIES



**C05470**  
44x228

TRENTA  
THIRTIES



**C02470**  
44x256

TRENTA  
THIRTIES

ALZANTI SCORREVOLI  
TILT AND SLIDE PATIO HANDLES



**C08270**  
44x229

TRENTA  
THIRTIES



**C09270**  
44x229

TRENTA  
THIRTIES



**C06870**  
44x256

CINQUANTA  
FIFTIES



**C07970**  
44x256

CINQUANTA  
FIFTIES

COPRI INTERRUTTORI  
SWITCH AND COVER PLATES

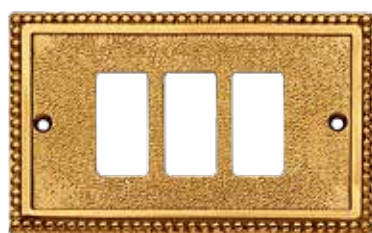
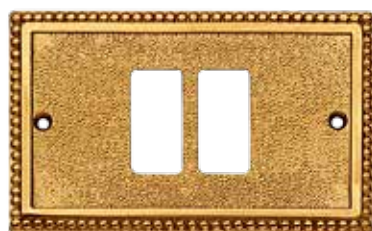

**C682**  
**01** (121x75)  
**02** (121x75)  
**03** (121x75)

IMPERO  
EMPIRE

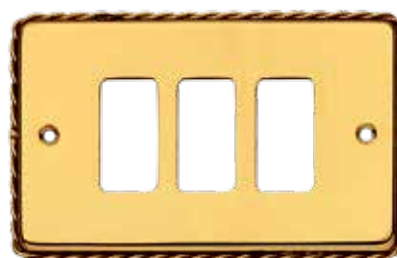
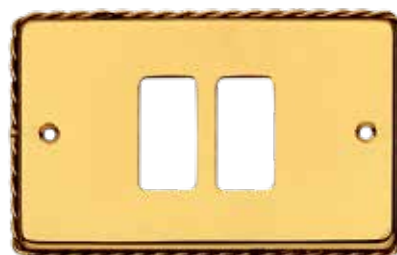
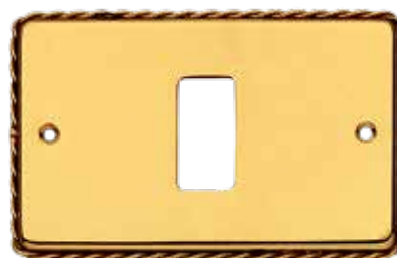

**C680**  
**01** (128x80)  
**02** (128x80)  
**03** (128x80)

NOVECENTO  
XX CENTURY

COPRI INTERRUTTORI  
.....  
SWITCH AND COVER PLATES

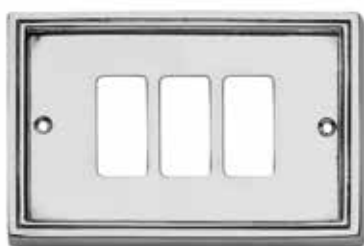
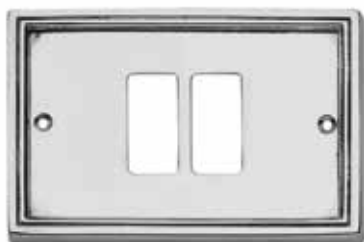

**C68101/02/03**

**01** (124x80)

**02** (124x80)

**03** (124x80)

NOVECENTO  
XX CENTURY



**C68111/12/13**

**11** (124x80)

**12** (124x80)

**13** (124x80)

NOVECENTO  
XX CENTURY

PLACCHE PORTANOME  
.....  
NAME AND NUMBER PLATES



**C64200**  
160x91

BAROCCO ITALIANO  
ITALIAN BAROQUE



**C64300**  
134x58

BAROCCO ITALIANO  
ITALIAN BAROQUE



**C64100**  
166x121

LUIGI XV  
LOUIS XV



**C64400**  
160x34

IMPERO  
EMPIRE



LE NOSTRE LAVORAZIONI

OUR PROCESSES





## STAMPAGGIO A CALDO

## HOT FORGING

La tecnologia dello stampaggio a caldo ha preso il posto della tradizionale fusione in quanto consente di ottenere Prodotti di qualità nettamente superiore ed una qualità costante del prodotto.

Le nostre macchine per lo stampaggio a caldo sono le più innovative e performanti disponibili sul mercato ed i nostri Tecnici sono in grado di ottimizzare al massimo il processo produttivo mantenendo il livello di qualità che contraddistingue le Officine Meccaniche Porro.

Hot forging technology has replaced the traditional metal casting process, since it allows producing more consistent and higher quality objects.

Our hot forging equipment is among the most innovative and efficient available on the market, and our technicians are able to optimize the production process, while preserving Officine Meccaniche Porro's renowned level of quality.



## PVD (PHYSICAL VAPOUR DEPOSITION)

## PVD (PHYSICAL VAPOUR DEPOSITION)

Ovvero il processo di deposizione molecolare in condizioni di alto vuoto e ad alte temperature che consentono ai nostri prodotti di avere un'elevatissima resistenza agli agenti chimici e atmosferici, illimitata resistenza all'ossidazione e un potenziamento di 4 volte della resistenza antigraffio rispetto ai normali rivestimenti galvanici.

PVD, or molecular deposition process in high vacuum conditions and at high temperatures, gives our products extreme resistance to chemical agents and meteorological elements, as well as unlimited resistance to oxidation and scratch-proof properties that are 4 times greater than those achieved by standard galvanized coatings.



## BOCCIARDATURA

## BUSH HAMMERING

Una speciale macchina consente di bocciardare ovvero rendere corrugata - ma sempre piacevole al tatto - la superficie in ottone pieno.

Questa lavorazione richiede un ritocco manuale al fine di ottenere un manufatto senza sbavature quindi assolutamente perfetto.

A special machine allows to bush-hammer, or corrugate, a full brass surface, making it pleasant to the touch. This process requires manual touch-ups in order to eliminate possible smearing and thus obtain a perfect finished product.

## FUSIONE A CERA PERSA

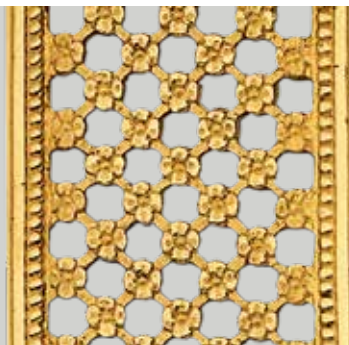

## LOST WAX CASTING PROCESS

Un modello in cera viene creato da un Mastro Cesellatore che poi lo riveste accuratamente di polvere ceramica per passarlo in forno a 1200°C.

La cera si fonde (cera persa) e, dell'oggetto, resta un calco in ceramica che fungerà da stampo per la fusione consentendoci di ottenere oggetti in metallo nobile con forme estremamente complesse e dettagli molto accurati.

A wax model is created by a Master Chiseller, who covers it thoroughly in ceramic powder and places it in an oven, at 1200°C.

The wax then melts away (lost wax) and the remaining ceramic cast will serve as a mold for the creation of noble metal objects featuring extremely complex shapes and very accurate details.

## CESELLATURA



## CHISELLING

Nonostante l'uso di stampi, siano essi gli storici o i più moderni delle collezioni contemporanee, alcuni particolari decorativi richiedono ancora la mano esperta del Mastro Cesellatore che va a rifinire e portare al dovuto risalto i particolari più minuti ottenendo un vero e proprio «pezzo d'arte» unico e immediatamente distinguibile.

Despite the use of molds, whether from historical or more contemporary collections, some decorative details still require the expert hand of the Master Chiseller, who refines and enhances the smallest details, thus producing a true, unique and immediately recognizable "art piece".

## LAVORAZIONE ARTIGIANALE



## CRAFTSMANSHIP

Tutte le nostre lavorazioni artigianali sono rese possibili dalla struttura produttiva della nostra Azienda che, pur consentendo una notevole rapidità di produzione, è strutturata per piccoli reparti che lavorano in sinergia tra loro.

Vere e proprie botteghe artigiane con il proprio Maestro che, con passione e attenzione, segue il lavoro del proprio gruppo trasmettendo le conoscenze e le tecniche più adatte ad ogni singola lavorazione.

All our creations are made possible by the production structure of our company that, while allowing for considerable speed of production, comprises small departments working in synergy with each other.

True artisan shops, each led by their Master with passion and attention.

Masters carefully oversee the work of their team, sharing the knowledge and techniques best suited to each task.



**DIAMANTATURA**

**DIAMOND DRESSING**

Con questo processo di finitura riusciamo a far «brillare» i nostri prodotti come un gioiello prezioso.

La lavorazione consente di ottenere purezza geometrica, planarità delle superfici e un'estrema luminosità; e, quindi si ottiene con l'utilizzo di un diamante naturale, considerato il minerale più duro ed abrasivo in natura.

Diamond dressing allows us to make our products shine like precious jewels.

The manufacturing process allows obtaining geometric purity, flat surfaces and extreme brightness. Diamond dressing is carried out by the use of a natural diamond, the hardest and most abrasive mineral in nature.



**CUSCINETTO**

**BALL BEARING**

Per le nostre maniglie abbiamo brevettato un innovativo cuscinetto a sfere in acciaio inox con fermo molla integrato e di uno spessore di soli 5 mm.

Grazie a questo nostro brevetto l'attrito meccanico viene eliminato consentendo una durata nel tempo ineguagliabile.

For our handles, we have patented an innovative stainless steel ball bearing with integrated spring stopper and a thickness of only 5 mm.

As a result, mechanical friction is totally eliminated, thus ensuring unmatched durability over time.



## MANIGLIE D'ARTE

Uniche sul mercato per la cura e la realizzazione nel rispetto di precisi canoni estetici.

## ASSORTIMENTO

Una collezione di maniglie che ripropone, con estrema cura dei particolari, maniglie di tutte le epoche dal 1630 ad oggi.

## FINITURE

Le nostre maniglie vengono ancora rifinite manualmente con la cura e la passione artigianale che contraddistinguono l'Eccellenza Italiana.

## MATERIE PRIME

Per le nostre maniglie - come per tutta la nostra produzione - vengono impiegate solo materie prime di elevata qualità.

## MISURE

Le misure sono espresse in millimetri. Le misure degli articoli indicate nel catalogo possono subire lievi modifiche di perfezionamento.

## 100% MADE IN ITALY

Tutti i prodotti Enrico Cassina, come tutta la produzione Officine Meccaniche Porro, sono garantiti come interamente concepiti e realizzati in Italia.

## ARTISTIC HANDLES

Unique on the market for the great attention to detail in compliance with particular aesthetic canons.

## RICH INVENTORY

A collection of handles that, with great attention to detail, reproduce handles of all art periods, stretching from 1630 to today.

## FINISHES

Our handles are decorated by hand with the great care and craftsmanship that embody Italian Excellence.

## RAW MATERIALS

For our handles, as well as for the rest of our production, we only use high-quality raw materials.

## MEASUREMENTS

All dimensions are in millimeters. Item's dimensions indicated in the price list could vary slightly according to the finished products' requirements.

## 100% MADE IN ITALY

Like the entire Officine Meccaniche Porro catalog, all Alfredo Porro accessories have been entirely designed and manufactured in Italy.



**CLASSICO/CLASSIC MODERNO/MODERN**



Oro Non Verniciato  
Polished Brass Not Lacquered



Oro Lucido  
Polished Brass



Oro PVD  
Polished Brass PVD



Bagno Oro  
Gold Plated



Bagno Oro PVD  
Gold PVD



Oro Antico PVD  
Old Gold PVD



Oro Imperiale  
Imperial Gold



Bronzo Antico  
Antique Bronze



Ottone Antico  
Ancient Brass



Oro Antico  
Old Gold



Bronzo Opaco  
Matt Bronze



Nero Opaco  
Matt Black



Nickel Lucido  
Nickel Plated



Nickel Satinato  
Satin Nickel



Cromo Lucido  
Chrome Plated



Cromo Satinato  
Satin Chrome

## ROCOCÒPOP

---



Pop Red



Pop Yellow



Pop Blue



Pop Purple



Pop Black



Pop White



Pop Matt Green



Pop Matt Blue



Pop Matt Black



Pop Matt White

## FINITURE SPECIALI

## SPECIAL FINISHING

---



Oro Satinato

Satin Brass



Argento Vecchio

Antique Silver



Patined Steel



Oil Rubbed  
Bronze



Bagno Argento

Silver Plated

### I COLORI DELLE FINITURE SONO INDICATIVI

Alcune finiture vengono eseguite manualmente e pertanto possono presentare variazioni di tonalità e sfumatura creando doti di unicità e bellezza del prodotto.

### THE COLOURS OF THE FINISHES ARE INDICATIVE

Some of the finishes are performed manually therefore variations in colour tone and shading may occur giving beauty and uniqueness to the product.











Credits

Progetto grafico / Graphic design  
Adf&R S.r.l. Milano

Impaginazione / Layout  
Adf&R S.r.l. Milano  
OMP PORRO S.r.l.

Stampa / Printing  
Arti Grafiche Meroni S.r.l.

Foto / Pictures  
- I.K.B.  
- Mimmo Capurso



# ENRICO CASSINA

MANUFACTURED BY OFFICINE MECCANICHE PORRO



**OMP PORRO S.r.l**

22060 Cucciago (CO) ITALY - via Stazione, 8/a  
tel. +39 031.787100 r.a. - fax +39 031.787575

[info@omporro.eu](mailto:info@omporro.eu)  
[enricocassina.it](http://enricocassina.it)