

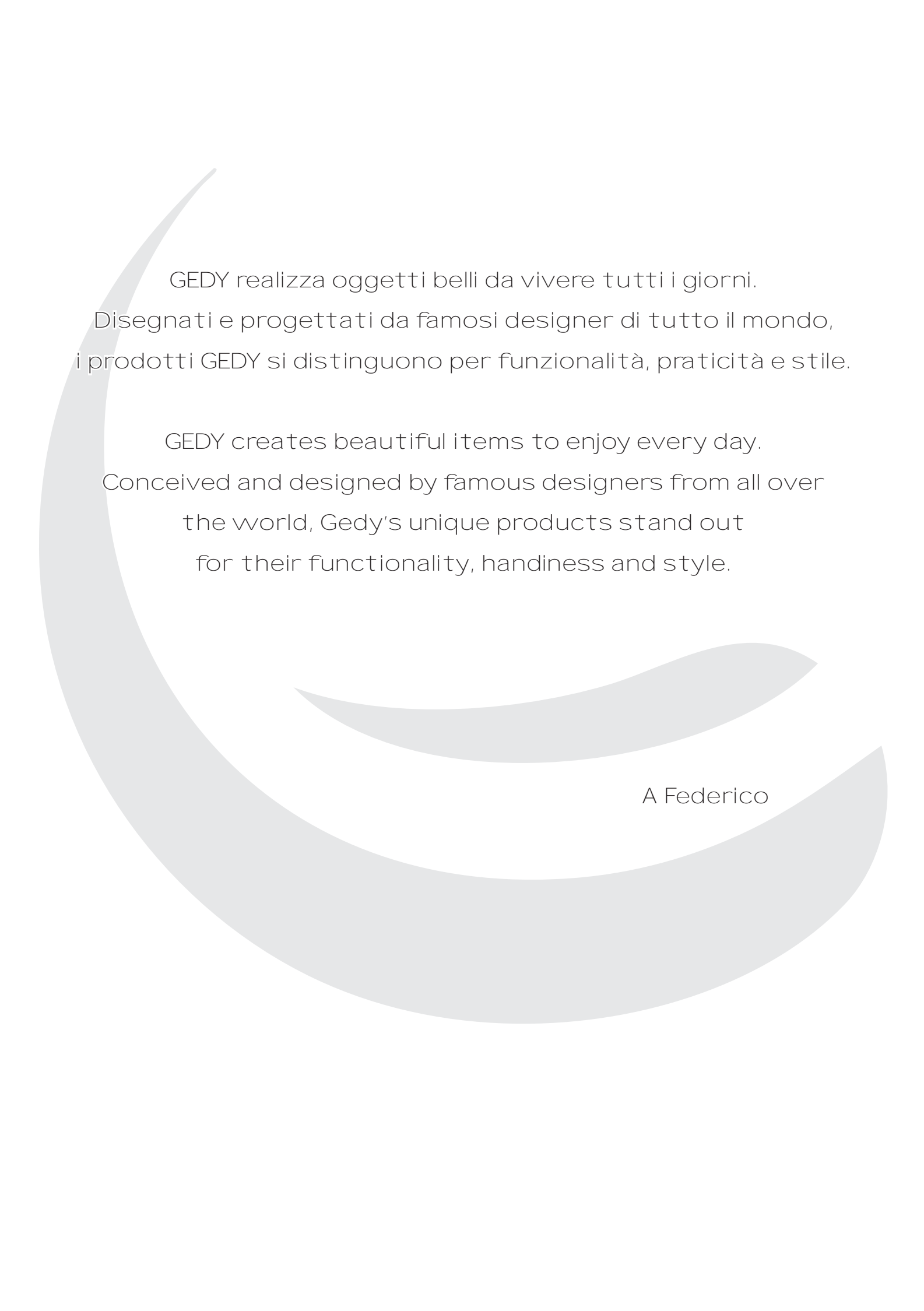

catalogo - catalogue

Katalog - catálogo - каталог



GEDY realizza oggetti belli da vivere tutti i giorni.  
Disegnati e progettati da famosi designer di tutto il mondo,  
i prodotti GEDY si distinguono per funzionalità, praticità e stile.

GEDY creates beautiful items to enjoy every day.  
Conceived and designed by famous designers from all over  
the world, Gedy's unique products stand out  
for their functionality, handiness and style.

A Federico



# Indice generale

TOP DESIGN pagina 3

RETAIL pagina 111

GEDY pagina 185

IDROTERAPIA pagina 481

CONTRACT pagina 563

La semplicità portata all'estremo  
diventa eleganza.

Simplicity, carried to an extreme,  
becomes elegance.

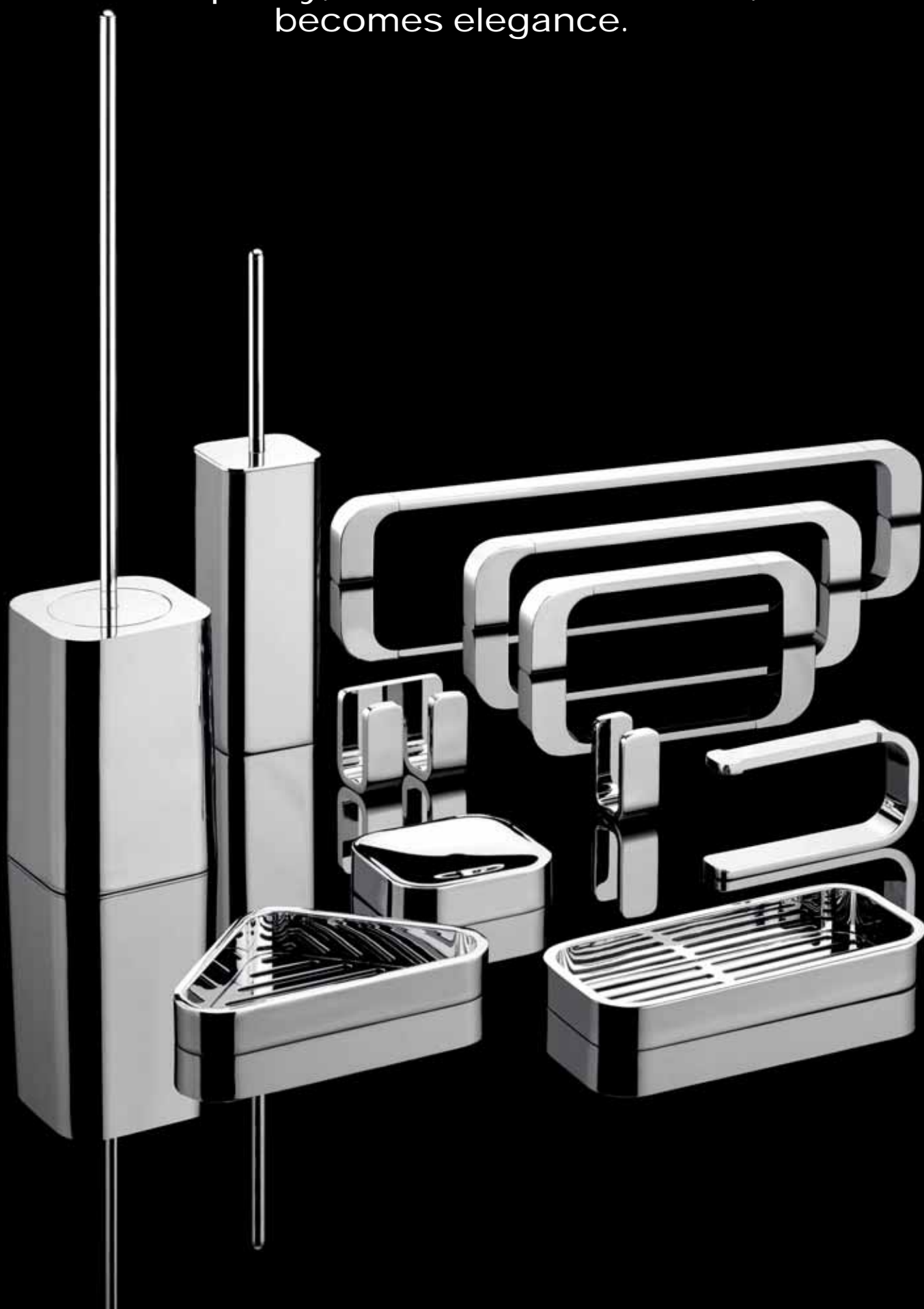





# Indice

TOP DESIGN

wall fittings

## serie da muro

G•AZZORRE pagina 22

G•BRIDGE pagina 62

G•CANARIE pagina 32

G•DEMETRA pagina 72

G•ELBA pagina 14

G•GEA pagina 78

G•LANZAROTE pagina 6

G•LOUNGE pagina 50

G•MALDIVE pagina 82

G•OUTLINE pagina 42

G•SISSI pagina 66

magnifying  
mirrors  
and lighting

## specchi ingranditori e illuminazione

pagina 86

decorative  
accessories

## complementi d'arredo

pagina 92

shower and bathtub  
accessories

## accessori zona doccia

pagina 102



TOP DESIGN



# G•LANZAROTE







A310

Portaspazzolini  
Toothbrush holder

7,8 x 9,5 x 12 cm

Porte brosse à dents  
Zahnbürstenhalter  
Portacepillos  
Стакан для зубных щёток

A311

Portasapone  
Soap holder

11 x 11 x 3 cm

Porte savon  
Seifenschale  
Jabonera  
Мыльница



A381

Dosasapone  
Soap dispenser

8,5 x 9,5 x 18,2 cm

Distributeur de savon  
Seifenspender  
Dosificador de jabón  
Диспенсер жидкого мыла

G•LANZAROTE

13 Cromato  
Chromed

Realizzata in ottone e Cromall® con contenitori in vetro satinato - Made of brass and Cromall® with frosted glass containers - Réalisée en laiton et Cromall® avec boîtiers en verre satiné - Hergestellt aus Messing und Cromall® mit Behältern aus satiniertem Glas - Realizada en latón y Cromall® con contenedores en cristal satinado - Изготовлено из латуни и Cromall® с ёмкостями из матового стекла

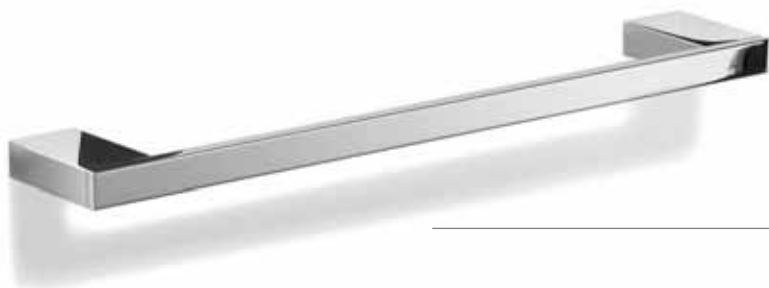

A321-30  
Portasalviette  
Towel holder  
32,8 x 6 x 1,5 cm

Porte serviette  
Handtuchhalter  
Toallero  
Полотенцедержатель



A321-45  
Portasalviette  
Towel holder  
48 x 6 x 1,5 cm

Porte serviette  
Handtuchhalter  
Toallero  
Полотенцедержатель



A321-60  
Portasalviette  
Towel holder  
63 x 6 x 1,5 cm

Porte serviette  
Handtuchhalter  
Toallero  
Полотенцедержатель



A323

Portasalvietta a snodo  
Jointed towel holder

4,5 x 37,5 x 3 cm

Porte serviette réglable  
Handtuchhalter schwenkbar  
Toallero articulado  
Полотенцедержатель  
на шарнирах

A324

Portarotolo  
Toilet paper holder  
17 x 6 x 2,2 cm

Porte rouleau  
Papierrollenhalter  
Portarrollos  
Бумагодержатель





A329

Portarotolo doppio  
Double paper holder

31 x 6 x 2,2 cm

Porte rouleau double  
Papierrollenhalter doppelt  
Portarrollos doble  
Двойной бумагодержатель



A325

Portarotolo coperto  
Paper holder with cover

17 x 11,5 x 6 cm

Porte rouleau avec couvercle  
Papierrollenhalter mit Deckel  
Portarrollos con tapa  
Бумагодержатель с крышкой







**A370**  
 Portasalviette ad anello  
 Towel ring  
 22 x 6 x 11 cm

Anneau porte serviette  
 Handtuchring  
 Toallero argolla  
 Полотенцедержатель "кольцо"

**A326**  
 Appendiabiti  
 Hook  
 2 x 4 x 6 cm

Crochet  
 Haken  
 Percha  
 Крючок





A333-O3

Scopino WC da muro con manico telescopico  
Wall toilet brush holder with telescopic handle

10 x 12 x 38 cm

Porte-brosse mural WC à mur avec manche télescopique  
Wand-Toilettenbürste mit ausziehbarem Stiel  
Escobillero de pared con mango telescópico  
Настенный туалетный ершик с телескопической ручкой

# G•ELBA



## FISSABILE ANCHE CON COLLA (VENDUTA A PARTE)

Can be fixed with glue (sold separately)  
Peut être fixé avec de la colle  
(vendu séparément)

Kann mit Kleber fixiert werden  
(separat erhältlich)

Может быть закреплен клеем  
(продается отдельно)







AO10

Portaspazzolini  
Tooth brush holder

7 x 10,5 x 10 cm

Porte brosse à dents  
Zahnbürstenhalter  
Portacepillos  
Стакан для зубных щёток

AO11

Portasapone  
Soap holder

12 x 13 x 4,5 cm

Porte savon  
Seifenschale  
Jabonera  
Мыльница



AO81

Dosasapone  
Soap dispenser

9,5 x 10,5 x 16 cm

Distributeur de savon  
Seifenspender  
Dosificador de jabón  
ДиДиспенсер для жидкого мыла



A021-30

Portasalviette  
Towel holder  
34,4 X 6,5 X 4,4 cm

Porte serviette  
Handtuchhalter  
Toallero  
Полотенцедержатель



A021-45

Portasalviette  
Towel holder  
49,4 X 6,5 X 4,4 cm

Porte serviette  
Handtuchhalter  
Toallero  
Полотенцедержатель

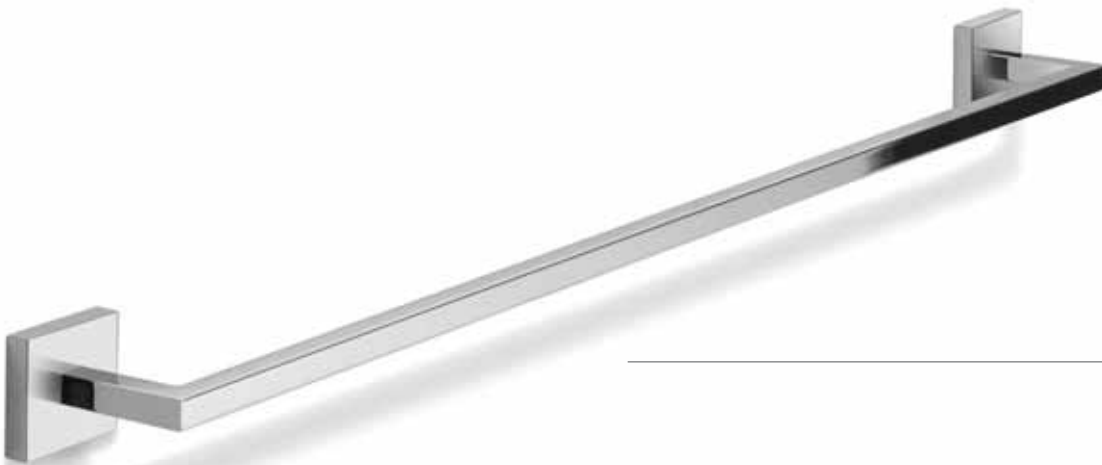

A021-60

Portasalviette  
Towel holder  
64,4 X 6,5 X 4,4 cm

Porte serviette  
Handtuchhalter  
Toallero  
Полотенцедержатель



AO22

Portasalviette fisso a 2 braccia  
Fixed towel rack with two rails

11 x 40 x 3 cm

Porte-serviette fixe 2 barres  
Handtuchhalter, fest, mit 2 Armen  
Toallero fijo de 2 brazos  
Полотенцедержатель  
(2 рожка)

AO26

Appendiabiti

Hook

4,4 x 5 x 5,4 cm

Crochet  
Haken  
Percha  
Крючок



120  
kg

AO21-28

Maniglione  
Grab bar

29,5 x 6,5 x 2,5 cm

Grab bar  
Barre d'appui  
Wannengriff  
Asidero  
Поручень

**AO70**

Portasalviette ad anello

Towel ring

22 x 5 x 12,8 cm

---

Anneau porte serviette  
Handtuchring  
Toallero argolla  
Полотенцедержатель "кольцо"

**AO24**Portarotolo  
Toilet paper holder

16,2 x 6,5 x 4,5 cm

---

Porte rouleau  
Papierrollenhalter  
Portarrollos  
Бумагодержатель





AO33

Scopino WC con ciuffo in setole  
Toilet brush holder with bristle brush

9,6 x 9,6 x 39,5 cm

---

Porte-brosse balai avec brosse en nylon  
WC-Bürstengarnitur mit Borsten-Aufsatz  
Escobillero con escobilla de nylon  
Туалетный ёршик с нейлоновой щетиной

AO33-03

Scopino WC da muro con ciuffo in setole  
Wall toilet brush holder with bristle brush

9,7 x 13 x 39 cm

Porte-brosse balai à mur avec brosse en nylon  
WC-Bürstengarnitur mit Borsten-Aufsatz mit Wandhalterung  
Escobillero de pared con escobilla de nylon  
Туалетный ёршик с нейлоновой щетиной



1161

## Kit Placca incollo

(2 placche + 1 tubo colla 3 ml + biadesivo)

2 wall plates, glue tube and double-sided adhesive tape for glue fixing  
(excluding A021-28/A022)

2 plaque murale, colle et biadhésif

pour fixation avec colle (à l'exclusion de A021-28/A022)

Packung mit 1 Wandplatte, Klebstofftube

und Klebebänder für Klebemontage (außer A021-28/A022)

Kit de fijación a la pared, tubo de cola 3 ml

y cintas adhesivas para fijación sin taladro (excepto A021-28/A022)

1 Комплект для приклеивания (накладка + 1 тубик с клеем

+двусторонняя клейкая лента)

(исключая A021-28/A022)



# G•AZZORRE







A110

Portaspazzolini  
Toothbrush holder

8,3 x 10 x 11,5 cm

Porte brosse à dents  
Zahnbürstenhalter  
Portacepillos  
Стакан для зубных щёток

A111

Portasapone  
Soap holder

11 x 11,6 x 4,1 cm

Porte savon  
Seifenschale  
Jabonera  
Мыльница



A181

Dosasapone  
Soap dispenser

10 x 10 x 17,6 cm

Distributeur de savon  
Seifenspender  
Dosificador de jabón  
Дозатор для жидкого мыла

# G•AZZORRE

13 Cromato  
Chromed

Realizzata in alluminio, ottone e Cromall® con contenitori in vetro satinato - Made of aluminium, brass and Cromall® with frosted glass containers - Réalisée en aluminium, laiton et Cromall® avec boîtiers en verre satiné - Hergestellt aus Aluminium, Messing und Cromall® mit Behältern aus satiniertem Glas - Realizada en aluminio, latón y Cromall® con contenedores en cristal satinado - Изготовлено из алюминия, латуни и Cromall® с ёмкостями из матового стекла



A121 - 30

Portasalviette  
Towel holder

34,5 x 5,7 x 2,4 cm

Porte serviette  
Handtuchhalter  
Toallero  
Полотенцедержатель



A121 - 45

Portasalviette  
Towel holder

49,5 x 5,7 x 2,4 cm

Porte serviette  
Handtuchhalter  
Toallero  
Полотенцедержатель

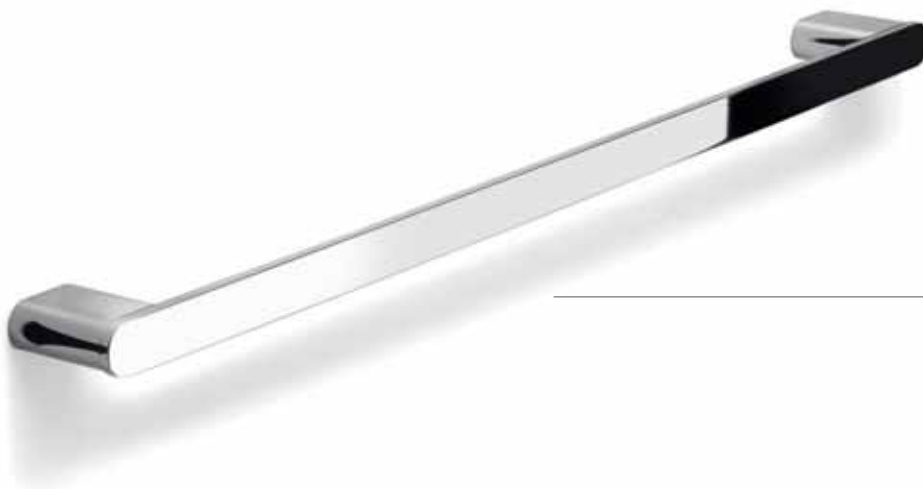

A121 - 60

Portasalviette  
Towel holder

64 x 5,7 x 2,4 cm

Porte serviette  
Handtuchhalter  
Toallero  
Полотенцедержатель

A123

Portasalviette a snodo  
Jointed towel holder

4 x 38 x 3,2 cm

Porte serviette réglable  
Handtuchhalter schwenkbar  
Toallero articulado  
Полотенцедержатель на шарнирах



A126

Appendiabiti doppio  
Double hook

7,2 x 3 x 3 cm

Crochet double  
Haken doppelt  
Percha doble  
Двойной крючок



A170

Portasalviette ad anello

Towel ring

21 x 10 x 2,5 cm

Anneau porte serviette  
Handtuchring  
Toallero argolla  
Полотенцедержатель "кольцо"



A125

Portarotolo coperto

Toilet paper holder with cover

13,5 x 3 x 12,5 cm

Porte rouleau avec couvercle  
Papierrollenhalter mit Deckel  
Portarrollos con tapa  
Бумагодержатель с крышкой



A124

Portarotolo

Toilet paper holder

18 x 5,5 x 3 cm

Porte rouleau  
Papierrollenhalter  
Portarrollos  
Бумагодержатель





A147

Portasalviette attrezzabile  
(accessori venduti separatamente)

Towel rail, with accessories  
(accessories supplied separately)

46,6 x 10,2 x 2,5 cm

---

Porte-serviette accessoirisable

Ausrüstbarer Handtuchhalter

Toallero equipabile

Полотенцедержатель

горизонтальный или вертикальный







A151

Portasapone per portasalvietta  
 attrezzabile A147  
 Soap dish accessory for towel rail A147

18 x 8,3 x 1,75 cm

Porte-savon pour porte-serviette accessoirisable A147  
 Seifenschale für ausrüstbaren Handtuchhalter A147  
 Jabonera para toallero equipable A147  
 Мыльница для полотенцедержателя A147

A155

Dosasapone per portasalvietta  
 attrezzabile A147  
 Soap dispenser accessory for towel rail A147

Ø 8,3 x 17 cm

Distributeur de savon pour porte-serviette accessoirisable A147  
 Seifendosierer für ausrüstbaren Handtuchhalter A147  
 Dosificador jabón para toallero equipable A147  
 Дозатор мыла для полотенцедержателя A147



A198

Bicchiere per portasalvietta attrezzabile A147  
 Glass accessory for towel rail A147

Ø 8,1 x 11,5 cm

Verre pour porte-serviette accessoirisable A147  
 Glas für ausrüstbaren Handtuchhalter A147  
 Vaso para toallero equipable A147  
 Стакан для Полотенцедержателя A147



A133-O3

Scopino WC da muro con manico telescopico  
e ciuffo in setole

Toilet brush holder with telescopic handle  
and bristle brush

9,8 x 11,9 x 43 cm

Porte-brosse WC à manche télescopique et brosse en nylon  
Toilettenbürste mit ausziehbarem Stiel und mit Borsten-Aufsatz  
Escobillero de pared con mango telescópico y escobilla de nylon  
Настенный туалетный ершик с телескопической  
ручкой с нейлоновой щетиной



# G•CANARIE







A210

Portaspazzolini  
Toothbrush holder

7,2 x 10 x 12 cm

Porte brosse à dents  
Zahnbürstenhalter  
Portacepillos  
Стакан для зубных щёток

A211

Portasapone  
Soap holder

11 x 11,5 x 4,5 cm

Porte savon  
Seifenschale  
Jabonera  
Мыльница



A281

Dosasapone  
Soap dispenser

9 x 10 x 18,5 cm

Distributeur de savon  
Seifenspender  
Dosificador de jabón  
Дозатор для жидкого мыла

G•CANARIE

13 Cromato  
Chromed

Realizzata in ottone e Cromall® con contenitori in vetro satinato - Made of brass and Cromall® with frosted glass containers  
Réalisée en laiton et Cromall® avec boîtiers en verre satiné - Hergestellt aus Messing und Cromall® mit Behältern aus satiniertem Glas  
Realizada en latón y Cromall® con contenedores en cristal satinado - Изготовлено из латуни и Cromall® с ёмкостями из матового стекла



A221-30

Portasalviette

Towel holder

35,4 x 7,2 x 2,2 cm

Porte serviette

Handtuchhalter

Toallero

Полотенцедержатель



A221-45

Portasalviette

Towel holder

50,5 x 7,2 x 2,2 cm

Porte serviette

Handtuchhalter

Toallero

Полотенцедержатель



A221-60

Portasalviette

Towel holder

65,5 x 7,2 x 2,2 cm

Porte serviette

Handtuchhalter

Toallero

Полотенцедержатель





A223

Portasalviette a snodo  
Jointed towel holder

6 x 36,5 x 2 cm

Porte serviette réglable  
Handtuchhalter schwenkbar  
Toallero articulado  
Полотенцедержатель на шарнирах



A270

Portasalviette ad anello  
Towel ring

20 x 3,5 x 10 cm

Anneau porte serviette  
Handtuchring  
Toallero argolla  
Полотенцедержатель "кольцо"

**A224**

Portarotolo  
Toilet paper holder  
19 x 7,2 x 2 cm

Porte rouleau  
Papierrollenhalter  
Portarrollos  
Бумагодержатель

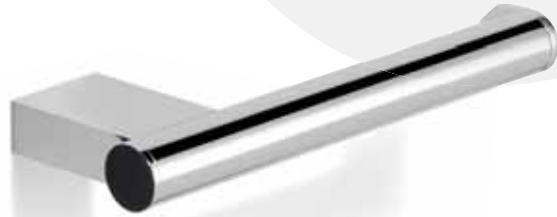
**A224-O2**

Portarotolo di riserva  
Spare toilet paper holder  
2 x 3 x 13 cm

Porte rouleau de reserve  
Ersatzpapierrollenhalter  
Portarrollos de reserva  
Держатель запасного рулона

**A229**

Portarotolo doppio  
Double toilet paper holder  
29,7 x 7 x 2 cm

Porte rouleau double  
Papierrollenhalter doppelt  
Portarrollos doble  
Двойной бумагодержатель

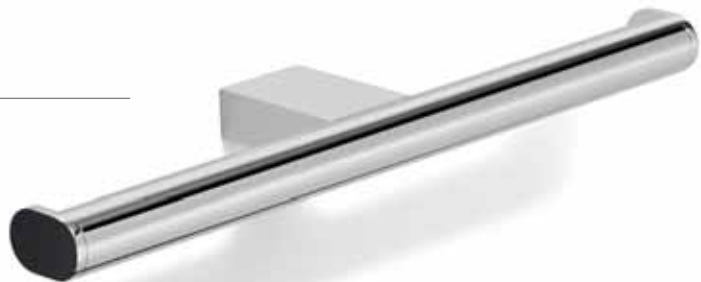



A225-01

Portarotolo coperto  
Toilet paper holder with cover  
13 x 10,5 x 13 cm

Porte rouleau avec couvercle  
Papierrollenhalter mit Deckel  
Portarrollos con tapa  
Бумагодержатель с крышкой

A225

Portarotolo coperto  
Toilet paper holder with cover  
13,3 x 3,5 x 12 cm

Porte rouleau avec couvercle  
Papierrollenhalter mit Deckel  
Portarrollos con tapa  
Бумагодержатель с крышкой



**A227****Appendiabiti  
Hook**

ø 1,9 x 3,4 cm

Crochet  
Haken  
Percha  
Крючок

**A226****Appendiabiti doppio  
Double hook**

7 x 3,5 x 1,8 cm

Crochet double  
Haken doppelt  
Percha doble  
Двойной крючок

**A228****Appendiabiti multiplo  
Multiple hook**

17,2 x 3,5 x 1,8 cm

Crochet quatre têtes  
Haken vierfach  
Percha cuádruple  
Мультикрючок

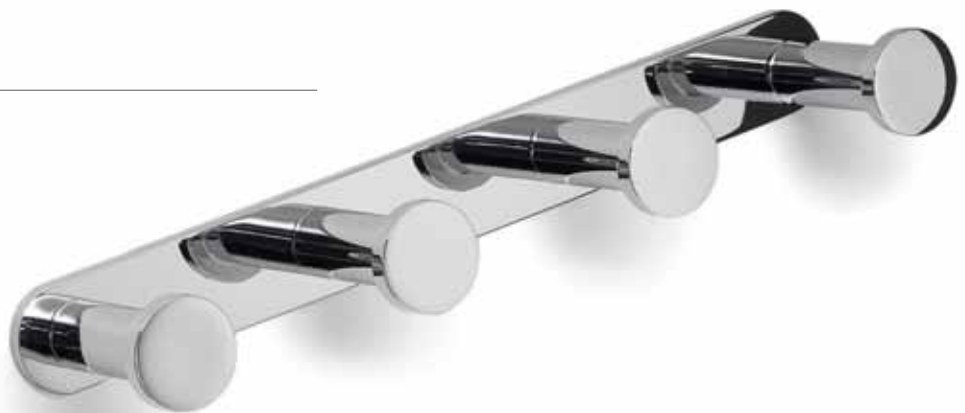



A221-28

Maniglione cm. 30

Grab bar cm. 30

30,5 x 7,5 x 2,5 cm

Barre d'appui cm 30

Wannengriff cm. 30

Asidero cm. 30

Поручень 30 см

A222

Maniglione 135°

Grab bar 135°

37,4 x 7,5 x 17,3 cm



Barre d'appui 135°

Wannengriff 135°

Asidero 135°

Поручень 135°



A235

Mensola portasalviette

Shelf for towels

62 x 25 x 14,5 cm

Étagère porte serviettes

Handtuchablage

Estante para toallas

Держатель полотенец



A233-O3

Scopino WC da muro con manico telescopico e ciuffo in setole  
Toilet brush holder with telescopic handle and bristle brush

10 x 12 x 47 cm

Porte-brosse WC mural WC à mur à manche télescopique et brosse en nylon  
WC-Bürste mit ausziehbarem Stiel und mit Borsten-Aufsatz mit Wandhalterung  
Escobillero de pared con mango telescópico y escobilla de nylon  
Настенный туалетный ершик с телескопической ручкой с нейлоновой щетиной



A233

Scopino WC con manico telescopico e ciuffo in setole  
Toilet brush holder with telescopic handle and bristle brush

ø10 x 47 cm

Porte-brosse WC à manche télescopique et brosse en nylon  
Toilettenbürste mit ausziehbarem Stiel und mit Borsten-Aufsatz  
Escobillero con mango telescópico y escobilla de nylon  
Настенный туалетный ершик с телескопической ручкой и нейлоновой щетиной

acciaio inox - stainless steel - acier inoxydable  
Edelstahl - acero inox - нержавеющей сталь



# G•OUTLINE

design  
Simone Micheli











3212

Portasapone inamovibile

Soap holder

12,1 x 11 x 3 cm

Porte savon  
Seifenschale  
Jabonera  
Несъемная мыльница

3218

Portaoggetti per doccia

Shower tray

24,1 x 11 x 3 cm

Porte-objets pour douche  
Seifenhalter für die Dusche  
Portaobjetos para ducha  
Полочка для душа



3283

Portaoggetti per doccia

Shower tray

17 x 17 x 3 cm

Porte-objets pour douche  
Seifenhalter für die Dusche  
Portaobjetos para ducha  
Полочка для душа



**G•OUTLINE** design Simone Micheli

**13** Cromato  
Chromed

**NEW**  
**22** Bianco  
White

**NEW**  
**14** Nero matt  
Matt black

Realizzata in ottone, acciaio inox e Cromall® - Made of brass, stainless steel and Cromall® - Réalisée en laiton, acier inoxydable et Cromall® - Hergestellt aus Messing, Edelstahl und Cromall® - Realizada en latón, acero inox y Cromall® - Изготовлено из латуни, нержавеющей стали и Cromall®



**3221 / 25**  
 Portasalviette/maniglione di sicurezza  
 Towel holder/grab bar  
 25,1 x 7 x 3 cm

Porte serviette/barre d'appui  
 Handtuchhalter/Wannengriff  
 Toallero/asidero  
 Полотенцедержатель/поручень



**3221 / 35**  
 Portasalviette/maniglione di sicurezza  
 Towel holder/grab bar  
 35,1 x 7 x 3 cm

Porte serviette/barre d'appui  
 Handtuchhalter/Wannengriff  
 Toallero/asidero  
 Полотенцедержатель/поручень



**3221 / 55**  
 Portasalviette/maniglione di sicurezza  
 Towel holder/grab bar  
 55,1 x 7 x 3 cm

Porte serviette/barre d'appui  
 Handtuchhalter/Wannengriff  
 Toallero/asidero  
 Полотенцедержатель/поручень



3224

Portarotolo  
Toilet paper holder

16 x 8,6 x 3 cm

Porte rouleau  
Papierrollenhalter  
Portarrollos  
Бумагодержатель

3224-O2

Portarotolo di riserva  
Spare toilet paper holder

8 x 12,2 x 16 cm

Porte rouleau de réserve  
Ersatzpapierrollenhalter  
Portarrollos de reserva  
Подставка для запасного рулона



3225

Portarotolo coperto  
Toilet paper holder with cover

11,7 x 14,2 x 9,6 cm

Porte rouleau avec couvercle  
Papierrollenhalter mit Deckel  
Portarrollos con tapa  
Бумагодержатель с крышкой



3226

Appendiabiti

Hook

3 x 4,6 x 7 cm

---

Crochet  
Haken  
Percha  
Крючок



3228

Appendiabiti doppio

Double hook

8,4 x 4,6 x 7 cm

---

Crochet double  
Haken doppelt  
Percha doble  
Двойной крючок



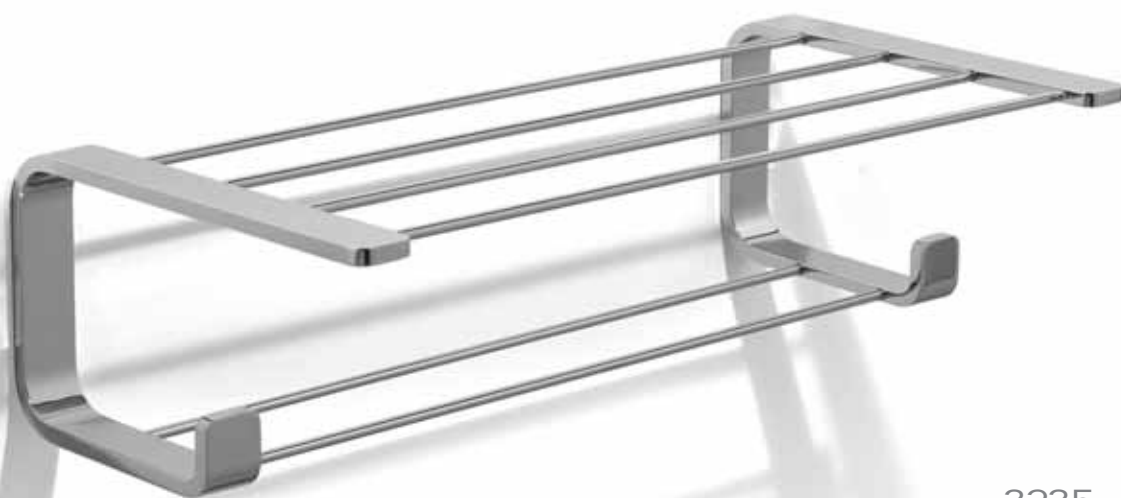

3235

Mensola portaasciugamani doppia  
Double shelf for towels

50 x 26 x 14 cm

Étagère porte serviette double  
Doppelhandtuchablage  
Estante doble para toallas  
Двойная полочка для полотенец

**3233-03**

Scopino WC da muro con ciuffo in setole  
Wall toilet brush holder with bristle brush

8 x 9,9 x 38,4 cm

Porte-brosse mural avec brosse en nylon  
WC-Bürstengarnitur mit Borsten-Aufsatz mit Wandhalterung  
Escobillero de pared con escobilla de nylon  
Туалетный ёршик с нейлоновой щетиной

**3233**

Scopino WC con ciuffo in setole  
Toilet brush holder with bristle brush

11,8 x 11,8 x 61,5 cm

Porte-brosse avec brosse en nylon  
WC-Bürstengarnitur mit Borsten-Aufsatz  
Escobillero con escobilla de nylon  
Туалетный ёршик с нейлоновой щетиной

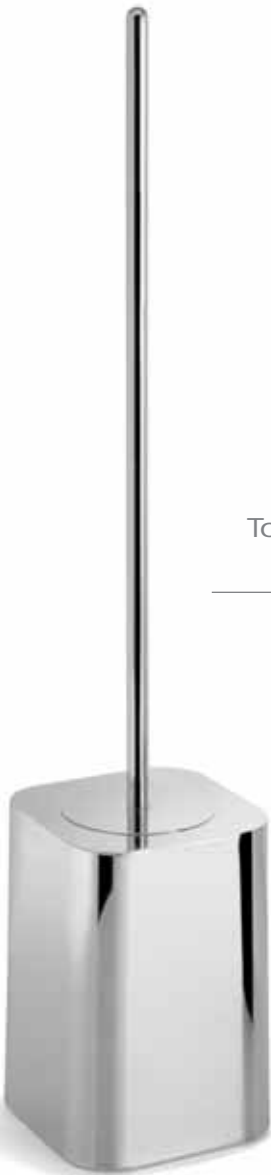
**13**

Disponibile solo in cromato  
Available only in chromed

# G• LOUNGE









5410

Portaspazzolini  
Toothbrush holder

7 x 9,5 x 9,9 cm

Porte brosse à dents  
Zahnbürstenhalter  
Portacepillos  
Стакан для зубных щёток

5411

Portasapone  
Soap holder

12 x 12 x 4,1 cm

Porte savon  
Seifenschale  
Jabonera  
Мыльница



5481

Dosasapone  
Soap dispenser

6,8 x 11,6 x 15,6 cm

Distributeur de savon  
Seifenspender  
Dosificador de jabón  
Дозатор для жидкого мыла

G•LOUNGE

13 Cromato  
Chromed

14 Nero matt  
Matt black

Realizzata in alluminio e Cromall® con contenitori in vetro satinato - Made of aluminium and Cromall® with frosted glass containers  
Réalisée en aluminium et Cromall® avec boîtiers en verre satiné - Hergestellt aus Aluminium und Cromall® mit Behältern aus satiniertem Glas  
Realizada en aluminio y Cromall® con contenedores en cristal satinado - Изготовлено из латуни и ёмкостями с Cromall® из матового стекла

**5412****Portasapone singolo in filo****Wire soap holder**

14 x 11 x 2,5 cm

Porte savon fil  
Einzel-Seifenablage  
Jabonera de rejilla  
Проволочная мыльница

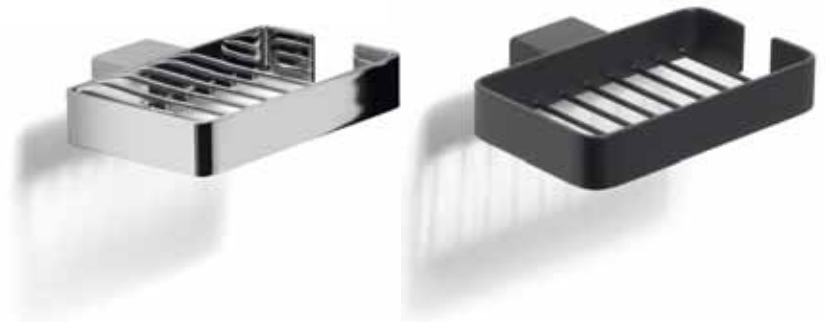
**5418****Portasapone doppio in filo**  
**Wire double soap holder**

24,6 x 13,7 x 2,5 cm

Porte savon double fil  
Doppelte Seifenablage  
Jabonera doble de rejilla  
Двойная проволочная мыльница

5421-45

Portasalviette  
Towel holder

44,2 x 5,4 x 2,4 cm

Porte serviette  
Handtuchhalter  
Toallero  
Полотенцедержатель



5421-60

Portasalviette  
Towel holder

59,2 x 5,4 x 2,4 cm

Porte serviette  
Handtuchhalter  
Toallero  
Полотенцедержатель

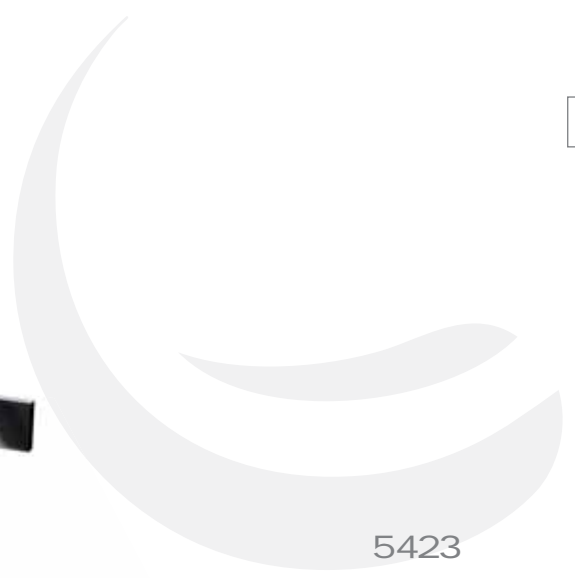

5423

Portasalvietta a snodo  
Jointed towel holder

4,6 x 37,5 x 2,6 cm

Porte serviette réglable  
Handtuchhalter schwenkbar  
Toallero articulado  
Полотенцедержатель на шарнирах



5470

Portasalvietta ad anello  
Towel ring

20,3 x 9,8 x 2,4 cm

Anneau porte serviette  
Handtuchring  
Toallero argolla  
Полотенцедержатель "кольцо"





5426  
 Appendiabiti doppio  
 Double hook  
 7 x 3 x 3 cm

Crochet double  
 Haken doppelt  
 Percha doble  
 Крючок

5424  
 Portarotolo  
 Toilet paper holder  
 13 x 9,6 x 2,2 cm

Porte rouleau  
 Papierrollenhalter  
 Portarrollos  
 Бумагодержатель



5425  
 Portarotolo coperto  
 Toilet paper holder with cover  
 13,1 x 13,9 x 4,6 cm

Porte rouleau avec couvercle  
 Papierrollenhalter mit Deckel  
 Portarrollos con tapa  
 Бумагодержатель с крышкой

13 Disponibile solo in cromato  
 Available only in chromed

5433-03

Scopino WC da muro con ciuffo in setole  
Wall toilet brush holder with bristle brush

8 x 11,2 x 40,4 cm

Porte-brosse mural avec brosse en nylon  
WC-Bürstengarnitur mit Borsten-Aufsatz mit Wandhalterung  
Escobillero de pared con escobilla de nylon  
Туалетный ёршик с нейлоновой щетиной



5433

Scopino WC  
con ciuffo in setole  
Toilet brush holder  
with bristle brush

8 x 8 x 40,4 cm

Porte-brosse avec brosse en nylon  
WC-Bürstengarnitur mit Borsten-Aufsatz  
Escobillero con escobilla de nylon  
Туалетный ёршик с нейлоновой щетиной

5447

Portasalvietta attrezzabile  
(accessori venduti separatamente)

Towel rail, with accessories  
(accessories supplied separately)

45 x 2,5 x 7,5 cm

Porte-serviette accessoirisable

Ausrüstbarer Handtuchhalter

Toallero equipabile

Полотенцедержатель

горизонтальный или вертикальный



G•LOUNGE

13 Cromato  
Chromed

14 Nero matt  
Matt black



5451

Portasapone per portasalviette  
attrezzabile 5447

Soap dish accessory for towel rail 5447

12 x 12 x 3 cm

Porte-savon pour porte-serviette accessoirisable 5447

Seifenschale für ausrüstbaren Handtuchhalter 5447

Jabonera para toallero equipable 5447

Мыльница для полотенцедержателя 5447

5455

Dosasapone per portasalviette  
attrezzabile 5447

Soap dispenser accessory for towel rail 5447

6,5 x 5,5 x 16,5 cm

Distributeur de savon pour porte-serviette accessoirisable 5447

Seifendosierer für ausrüstbaren Handtuchhalter 5447

Dosificador jabón para toallero equipable 5447

Дозатор мыла для полотенцедержателя 5447



5498

Bicchiere per portasalviette attrezzabile 5447

Glass accessory for towel rail 5447

7 x 7 x 10,5 cm

Verre pour porte-serviette accessoirisable 5447

Glas für ausrüstbaren Handtuchhalter 5447

Vaso para toallero equipable 5447

Стакан для полотенцедержателя 5447





5498

Portaspazzolini  
Toothbrush holder

7 x 7 x 10 cm

Porte brosse à dents  
Zahnbürstenhalter  
Portacepillos  
Стакан для зубных щёток

5451

Portasapone  
Soap holder

11,8 x 11,8 x 5 cm

Porte savon  
Seifenschale  
Jabonera  
Мыльница



5455

Dosasapone  
Soap dispenser

7 x 8,9 x 15,5 cm

Distributeur de savon  
Seifenspender  
Dosificador de jabón  
Дозатор для жидкого мыла



5498

Portaspazzolini  
Toothbrush holder

7 x 7 x 10 cm

Porte brosse à dents  
Zahnbürstenhalter  
Portacepillos  
Стакан для зубных щёток

5451

Portasapone  
Soap holder

11,8 x 11,8 x 5 cm

Porte savon  
Seifenschale  
Jabonera  
Мыльница



5455

Dosasapone  
Soap dispenser

7 x 8,9 x 15,5 cm

Distributeur de savon  
Seifenspender  
Dosificador de jabón  
Дозатор для жидкого мыла

# G•BRIDGE

design  
Carlo Martino







7630

Barra con 3 portasalviette scorrevoli  
Rack with 3 sliding towel rails

40,6 (max 56,2) x 8,3 x 22,6 cm

Barre avec 3 porte-serviettes coulissants  
Stange mit 3 verschiebbaren Handtuchhaltern  
Barra con 3 toalleros deslizantes  
Вешалка для полотенец с тремя перемещающимися перекладинами

7640

Barra con portarotolo doppio e scopino WC  
Rack with double toilet roll holder and toilet brush

30,2 x 12,7 x 37 cm

Barre avec porte-papier WC double et porte-brosse WC  
Stange mit doppeltem Rollenhalter und WC-Bürste  
Barra con portarrollos doble y escobillero  
Двойной держатель для туалетной бумаги с туалетным ершиком



7633-03

Scopino WC da muro con ciuffo in setole  
Wall toilet brush holder with bristle brush

8 x 10 x 39,2 cm

Porte-brosse mural avec brosse en nylon  
WC-Bürstengarnitur mit Borsten-Aufsatz mit Wandhalterung  
Escobillero de pared con escobilla de nylon  
Туалетный ёршик с нейлоновой щетиной



**G•BRIDGE** design Carlo Martino

13 Cromato Chromed

Realizzata in ottone, acciaio inox, Cromall® e contenitori in vetro satinato - Made of brass, stainless steel, Cromall® and frosted glass containers - Réalisée en laiton, acier inoxydable, Cromall® et boîtiers en verre satiné  
Hergestellt aus Messing, Edelstahl, Cromall® und Behältern aus satiniertem Glas - Realizada en latón, acero inox, Cromall® y contenedores en cristal satinado - Изготовлено из латуни, нержавеющей стали, Cromall® и матового стекла



7633

Scopino WC con ciuffo in setole  
Toilet brush holder with bristle brush

8 x 8 x 39,2 cm

Porte-brosse avec brosse en nylon  
WC-Bürstengarnitur mit Borsten-Aufsatz  
Escobillero con escobilla de nylon  
Туалетный ёршик с нейлоновой щетиной

7631

Piantana con 3 portasalviette scorrevoli  
Towel stand with 3 sliding towel rails

40,6 (max 52,6) x 16 x 92 cm

3 porte-serviettes coulissants sur pied  
Ständer mit 3 verschiebbaren Handtuchhaltern  
Toallero de pie con 3 barras deslizantes  
Вертикальная вешалка с тремя перемещающимися перекладинами  
для полотенец



7632

Colonnina portarotolo e scopino WC  
Bathroom butler with toilet paper holder and toilet brush

30 x 16 x 69 cm

Ensemble porte papier et brosse WC  
Ständer mit Papierrollenhalter und WC Bürstengarnitur  
Columna portarrollos y escobillero  
Стойка для ванной с туалетным ершиком и бумагодержателем



# G•SISSI

design  
Carallo-Grandis









**3310**  
Portaspazzolini  
Toothbrush holder  
11,7 x 12 x 14,7 cm

Porte brosse à dents  
Zahnbürstenhalter  
Portacepillos  
Стакан для зубных щёток

**3311**  
Portasapone  
Soap holder  
14,8 x 12,9 x 6,2 cm

Porte savon  
Seifenschale  
Jabonera  
Мыльница



**3381**  
Dosasapone  
Soap dispenser  
11,6 x 11,9 x 17,5 cm

Distributeur de savon  
Seifenspender  
Dosificador de jabón  
Дозатор для жидкого мыла

**G•SISSI**

design Carallo-Grandis

**13** Cromato  
Chromed

**87** Oro  
Gold

Trattamento oro PVD  
PVD gold plated

Realizzata in Cromall® con contenitori in vetro satinato - Made of Cromall® with frosted glass containers - Réalisée en Cromall® avec boîtiers en verre satiné - Hergestellt aus Cromall® mit Behältern aus satiniertem Glas - Realizada en Cromall® con contenedores en cristal satinado  
Изготовлено из Cromall® с ёмкостями из матового стекла

3319-60

Mensola  
Shelf

60 x 11,5 x 1,5 cm



Étagère - Ablage - Estante - Полочка

Vetro temperato - tempered glass  
Verre tempéré - Sekuritglas  
Cristal templado - Из закаленного стекла

3321-40

Portasalviette  
Towel holder

40,2 x 5,5 x 6,4 cm

Porte serviette  
Handtuchhalter  
Toallero  
Полотенцедержатель

3321-60

Portasalviette  
Towel holder

60,3 x 5,5 x 6,4 cm

Porte serviette  
Handtuchhalter  
Toallero  
Полотенцедержатель

3370

Portasalviette ad anello

Towel ring

18,7 x 5,5 x 17,9 cm

Anneau porte serviette  
Handtuchring  
Toallero argolla  
Полотенцедержатель "кольцо"



3326

Appendiabiti doppio

Double hook

9,6 x 5,5 x 5,6 cm

Crochet double  
Haken doppelt  
Percha doble  
Двойной крючок



3324

Portarotolo

Toilet paper holder

17,2 x 5,5 x 6,8 cm

Porte rouleau  
Papierrollenhalter  
Portarrollos  
Бумагодержатель





3333

Scopino WC con ciuffo in setole  
Toilet brush holder with bristle brush

ø 11,2 x 37,9 cm

Porte-brosse avec brosse en nylon  
WC-Bürstengarnitur mit Borsten-Aufsatz  
Escobillero con escobilla de nylon  
Туалетный ёршик с нейлоновой щетиной

# G•DEMETRA







5110

Portaspazzolini  
Toothbrush holder

7,5 x 11,5 x 12 cm

Porte brosse à dents  
Zahnbürstenhalter  
Portacepillos  
Стакан для зубных щёток

5111

Portasapone  
Soap holder

16 x 11,5 x 5,5 cm

Porte savon  
Seifenschale  
Jabonera  
Мыльница



5181

Dosasapone  
Soap dispenser

10 x 12,5 x 18 cm

Distributeur de savon  
Seifenspender  
Dosificador de jabón  
Дозатор для жидкого мыла



# G•DEMETRA

13 Cromato  
Chromed

Realizzata in ottone con contenitori in vetro satinato - Made of brass with frosted glass containers - Réalisée en laiton avec boîtiers en verre satiné - Hergestellt aus Messing mit Bechern, Schalen und Ablage in Mattglas - Realizada en latón con contenedores en cristal satinado - Изготовлено из латуни с ёмкостями из матового стекла





5121 - 30  
Portasalvietta  
Towel holder  
34,5 x 7 x 4,5 cm

Porte serviette  
Handtuchhalter  
Toallero  
Полотенцедержатель



5121 - 45  
Portasalvietta  
Towel holder  
49,5 x 7 x 4,5 cm

Porte serviette  
Handtuchhalter  
Toallero  
Полотенцедержатель



5121 - 60  
Portasalvietta  
Towel holder  
64,5 x 7 x 4,5 cm

Porte serviette  
Handtuchhalter  
Toallero  
Полотенцедержатель





5123

Portasalviette a snodo  
Jointed towel holder

43,5 x 5,5 x 9 cm

Porte serviette réglable  
Handtuchhalter schwenkbar  
Toallero articulado  
Полотенцедержатель на шарнирах

5170

Portasalviette ad anello  
Towel ring

24,8 x 8,5 x 14,5 cm

Anneau porte serviette  
Handtuchring  
Toallero argolla  
Полотенцедержатель "кольцо"



5127

Appendiabiti

Hook

4,5 x 6,7 x 6 cm

Crochet  
Haken  
Percha  
Крючок



5125

Portarotolo coperto

Toilet paper holder with cover

15,3 x 8,5 x 11 cm

Porte rouleau avec couvercle  
Papierrollenhalter mit Deckel  
Portarrollos con tapa  
Бумагодержатель с крышкой



5124

Portarotolo  
Toilet paper holder

15,5 x 8,5 x 4,5 cm

Porte rouleau  
Papierrollenhalter  
Portarrollos  
Бумагодержатель



# G•GEA



**SOLO SU SUPERFICI LISCE  
(SPECCHI, PIASTRELLE)**

**FOR FLAT SURFACES  
(MIRRORS, TILES) ONLY**

Fissaggio con biadesivo

To be fixed with double-sided sticky tape

Fixation avec adhésif double face

Befestigung mit doppelseitigem Klebeband

Fijación con biadhesivo

Крепление при помощи двухсторонней  
клеякой ленты







3610

Portaspazzolini  
Toothbrush holder

8,3 x 10 x 12,5 cm

Porte brosse à dents  
Zahnbürstenhalter  
Portacepillos  
Стакан для зубных щёток

3611

Portasapone  
Soap holder

11 x 11,5 x 5,5 cm

Porte savon  
Seifenschale  
Jabonera  
Мыльница



3626

Appendiabiti  
Hook

5,5 x 4,3 x 6,3 cm

Crochet - Haken  
Percha - Крючок



3670

Portasalviette ad anello  
Towel ring

19,3 x 6 x 21,4 cm

Anneau porte serviette  
Handtuchring  
Toallero argolla  
Полотенцедержатель "кольцо"



3621-35

Portasalviette  
Towel holder

36 x 6 x 5,5 cm

Porte serviette  
Handtuchhalter  
Toallero  
Полотенцедержатель

3621-50

Portasalviette  
Towel holder

51 x 6 x 5,5 cm

Porte serviette  
Handtuchhalter  
Toallero  
Полотенцедержатель

3621-65

Portasalviette  
Towel holder

66 x 6 x 5,5 cm

Porte serviette  
Handtuchhalter  
Toallero  
Полотенцедержатель

3624

Portarotolo  
Toilet paper holder  
16 x 6 x 5,5 cmPorte rouleau  
Papierrollenhalter  
Portarrollos  
Бумагодержатель

3625

Portarotolo coperto  
Toilet paper holder with cover

13,8 x 4,5 x 13 cm

Porte rouleau avec couvercle  
Papierrollenhalter mit Deckel  
Portarrollos con tapa  
Бумагодержатель с крышкой



# G•MALDIVE







**A621-38**

Maniglione/Portasalviette

Grab bar/Towel holder

38 x 6,5 x 3 cm



Barre d'appui/porte serviette  
 Wannengriff/Handtuchhalter  
 Asidero/toallero  
 Поручень/полотенцедержатель

Cromall®

**A621-50**

Maniglione/Portasalviette

Grab bar/Towel holder

50 x 6,5 x 3 cm



Barre d'appui/porte serviette  
 Wannengriff/Handtuchhalter  
 Asidero/toallero  
 Поручень/полотенцедержатель

**A621-65**

Maniglione/Portasalviette

Grab bar/Towel holder

65 x 6,5 x 3 cm



Barre d'appui/porte serviette  
 Wannengriff/Handtuchhalter  
 Asidero/toallero  
 Поручень/полотенцедержатель

**G•MALDIVE****13** Cromato  
Chromed

Realizzata in ottone e Cromall® - Made of brass and Cromall® - Réalisée en laiton et Cromall® - Hergestellt aus Messing und Cromall®  
 Realizada en latón et Cromall® - Изготовлено из латуни и Cromall®

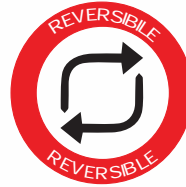

A622

Maniglione 135°

Grab bar 135°

56 x 6,5 x 22,8 cm

Barre d'appui 135° - Wannengriff 135° - Asidero 135° - Поручень 135°

A624

Portarotolo

Toilet paper holder

23,5 x 9,5 x 6,5 cm

Porte rouleau  
 Papierrollenhalter  
 Portarrollos  
 Бумагодержатель





## SPECCHI INGRANDITORI E ILLUMINAZIONE

Magnifying mirrors and lighting

Miroirs grossissants et luminaires

Vergrößerungsspiegel und Beleuchtung

Espejos de aumento e Iluminación

Увеличительные зеркала и подсветка

Tritan™ un prodotto innovativo e altamente tecnologico. Esclusivo copolyestere, con superlative prestazioni e durata rispetto ad altri materiali plastici, vetro e metallo.

Tritan™ an innovative and high-tech product. Exclusive copolyester, with outstanding performance and durability compared to other plastics, glass and metal.

Tritan™ - [http://www.eastman.com/brands/Eastman\\_Tritan/Media\\_Center/Video\\_Library/Pages/toughness.aspx](http://www.eastman.com/brands/Eastman_Tritan/Media_Center/Video_Library/Pages/toughness.aspx)



3,5 X



IP54

RoHS



600 LUX

90 CRI



AUTO OFF 15min

## A602

Specchio da parete ingranditore con luce LED  
Wall magnifying mirror with LED light

23,5 x 23,5 x 9,4 x 39 cm

Miroir à mural grossissant avec éclairage LED

Vergrößerungs-Wandspiegel mit Beleuchtung LED

Espejo de aumento de pared con luz LED

Настенное увеличительное зеркало со светодиодной подсветкой



## G•MALDIVE

13 Cromato  
Chromed

Realizzato in ottone/Cromall®/Tritan™ - Made of brass/Cromall®/Tritan™ - Réalisé en laiton /Cromall®/Tritan™ - Hergestellt aus Messing/Cromall®/Tritan™ - Realizado en latón/Cromall®/Tritan™ - Изготовлено из латуни/Cromall®/Tritan™



A601

Specchio da parete ingranditore

Wall magnifying mirror

21,2 x 21,2 x 14,8/44,3 cm

Miroir à mural grossissant

Vergrößerungs - Wandspiegel

Espejo de aumento de pared

Настенное увеличительное зеркало

3,5 X



A600

Specchio da parete ingranditore

Wall magnifying mirror

ø 21,2 x 13,9/43,3 cm

Miroir à mural grossissant

Vergrößerungs - Wandspiegel

Espejo de aumento de pared

Настенное увеличительное зеркало



3,5 X



G•MALDIVE

13 Cromato  
Chromed

Realizzato in ottone/Cromall®/Tritan™ - Made of brass/Cromall®/Tritan™ - Réalisé en laiton /Cromall®/Tritan™ - Hergestellt aus  
Messing/Cromall®/Tritan™ - Realizado en latón/Cromall®/Tritan™ - Изготовлено из латуни/Cromall®/Tritan™



2118

Specchio ingranditore  
da parete con luce LED  
Wall magnifying mirrors with LED light  
ø 25x12,3/36 cm

Miroir grossissant avec éclairage LED  
Kosmetikspiegel mit Beleuchtung LED  
Espejos de aumento con luz LED  
Увеличительный зеркало со светодиодной  
подсветкой



IP 42



5 X

G•VINCENT

13 Cromato  
Chromed

Realizzato in acciaio inox - Made of stainless steel - Réalisé en acier inox - Hergestellt aus Edelstahl - Realizado en acero inoxidable  
Изготовлено из нержавеющей стали



## DO40

Lampada a Led con attacco universale  
per specchi senza cornice  
LED lamp with universal coupling  
for unframed mirrors

10 x 16,8 x 3,4 cm

Lampes LED avec fixation universelle  
pour miroirs sans cadre  
LED-Lampe mit Universal-Befestigung für rahmenlose Spiegel  
Lámpara de led con enganche universal  
para espejos sin marco  
Светодиодная лампа с универсальным  
креплением на зеркала без рамы



IP 44  
230V-50Hz  
LED 4.4W  
420 LM  
CLASS EXEMPT GROUP

## DO40-01

Lampada a Led con telaio di fissaggio  
predisposto per specchi senza cornice  
LED lamp with fastening frame  
for unframed mirrors

10 x 15,5 x 4,2 cm

Lampes LED avec cadre de fixation conçu  
pour les miroirs sans cadre  
LED-Lampe mit Befestigungsrahmen für rahmenlose Spiegel  
Lámpara de led con bastidor de fijación para espejos sin marco  
Светодиодная лампа с креплением на зеркала без рамы



IP 44  
230V-50Hz  
LED 4.4W  
420 LM  
CLASS EXEMPT GROUP



**DO41**

Lampada a Led con attacco universale  
per specchi senza cornice  
LED lamp with universal coupling  
for unframed mirrors

8,1 x 14,8 x 3,2 cm

Lampes LED avec fixation universelle  
pour miroirs sans cadre  
LED-Lampe mit Universal-Befestigung für rahmenlose Spiegel  
Lámpara de led con enganche universal  
para espejos sin marco  
Светодиодная лампа с универсальным  
креплением на зеркала без рамы



IP 44  
230V-50Hz  
LED 4.4W  
450 LM  
CLASS EXEMPT GROUP

**DO41-O1**

Lampada a Led con telaio di fissaggio  
predisposta per specchi senza cornice  
LED lamp with fastening frame  
for unframed mirrors

8,1 x 13,5 x 4,2 cm

Lampes LED avec cadre de fixation conçu  
pour les miroirs sans cadre  
LED-Lampe mit Befestigungsrahmen  
für rahmenlose Spiegel  
Lámpara de led con bastidor de fijación  
para espejos sin marco  
Светодиодная лампа с креплением на зеркала без рамы



IP 44  
230V-50Hz  
LED 4.4W  
450 LM  
CLASS EXEMPT GROUP

**G•MAIORCA**

**13** Cromato  
Chromed

Realizzate in Cromall® e resine termoplastiche - Made of Cromall® and thermoplastic resins - Réalisées en Cromall® et thermoplastique  
Hergestellt aus Cromall® und Kunststoff - Realizadas en Cromall® y resinas termoplásticas - Изготовлено из Cromall® и термопластичных смол



# COMPLEMENTI D'ARREDO

Decorative accessories

Accessoires complémentaires

Einrichtungszubehör

Artículos de decoración

Декоративные аксессуары





## D031

Piantana portasciugamani

Towel stand

40 x 15 x 80 cm

Porte serviette sur pied  
Handtuchständer  
Toallero de pie  
Стойка для полотенец

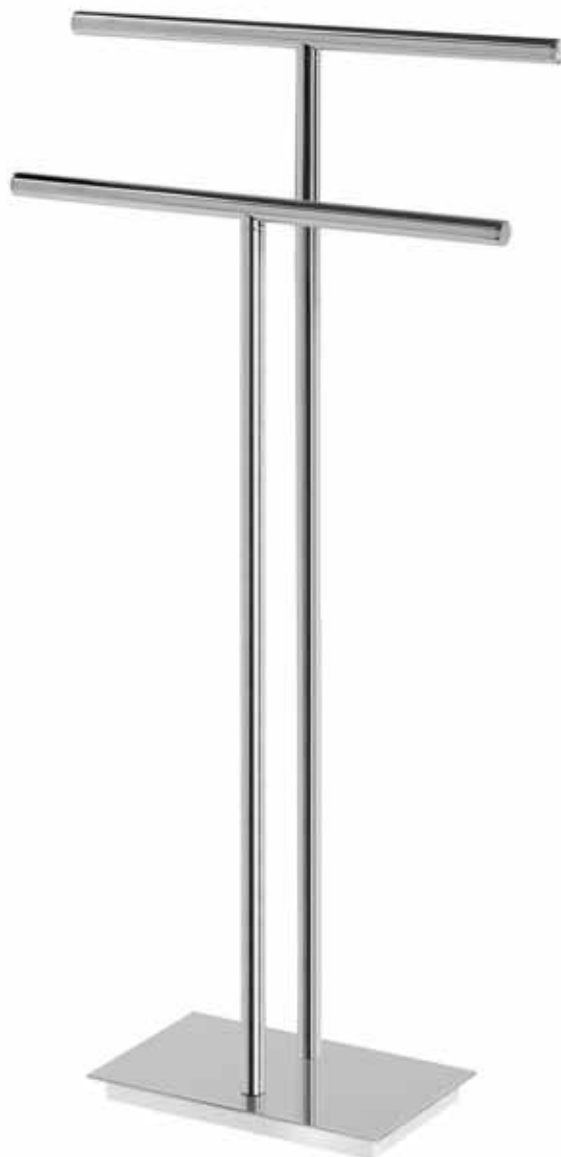

## D032

Colonnina portarotolo e scopino WC  
Bathroom butler with toilet paper holder  
and toilet brush

34 x 15 x 68,9 cm

Ensemble porte papier et brosse WC  
Ständer mit Papierrollenhalter und WC Bürstengarnitur  
Columna portarrollos y escobillero  
Стойка для ванной с туалетным ершиком и бумагодержателем

G•BERMUDA

13 Cromato  
Chromed

Realizzate in ottone e acciaio inox - Made of brass and stainless steel - Réalisées en laiton et acier inoxydable - Hergestellt aus Messing und Edelstahl - Realizados en latón y acero inox - Изготовлено из латуни и нержавеющей стали

7631

Piantana con 3 portasalviette scorrevoli

Towel stand with 3 sliding towel rails

40,6 (max 52,6) x 16 x 92 cm

3 porte-serviettes coulissants sur pied  
 Ständer mit 3 verschiebbaren Handtuchhaltern  
 Toallero de pie con 3 barras deslizantes  
 Вертикальная вешалка с тремя  
 перемещающимися  
 перекладинами для полотенец



7632

Colonnina portarotolo e scopino WC  
 Bathroom butler with toilet paper holder  
 and toilet brush

30 x 16 x 69 cm

Ensemble porte papier et brosse WC  
 Ständer mit Papierrollenhalter und WC Bürstengarnitur  
 Columna portarrollos y escobillero  
 Стойка для ванной с туалетным ершиком и бумагодержателем

G•BRIDGE Design: Carlo Martino

13 Cromato  
Chromed

Realizzate in ottone, acciaio inox e Cromall® - Made of brass, stainless steel and Cromall® - Réalisées en laiton, acier inoxydable et Cromall® - Hergestellt aus Messing, Edelstahl und Cromall® - Realizados en latón, acero inox y Cromall®  
 Изготовлено из латуни, нержавеющей стали и Cromall®



**D027**  
 Appendiabiti  
 Hook  
 Ø 3,5 x 4,4 cm

Crochet  
 Haken  
 Percha  
 Крючок

Ottone - Brass - Laiton - Messing - Latón - Латунь

**D026**  
 Appendiabiti doppio  
 Double hook  
 11,5 x 4 x 5,3 cm

Crochet double  
 Haken doppelt  
 Percha doble  
 Двойной крючок



**Fissaggio con biadesivo**  
**Biadhesive fixing**



**Fissaggio con biadesivo**  
**Biadhesive fixing**

**D028**  
 Appendiabiti  
 Hook  
 Ø 5,9 x 4 cm

Crochet  
 Haken  
 Percha  
 Крючок

D127

Appendiabiti  
Hook

5,3 X 5,3 x 4 cm

Crochet  
Haken  
Percha  
Крючок



Fissaggio con biadesivo  
Biadhesive fixing

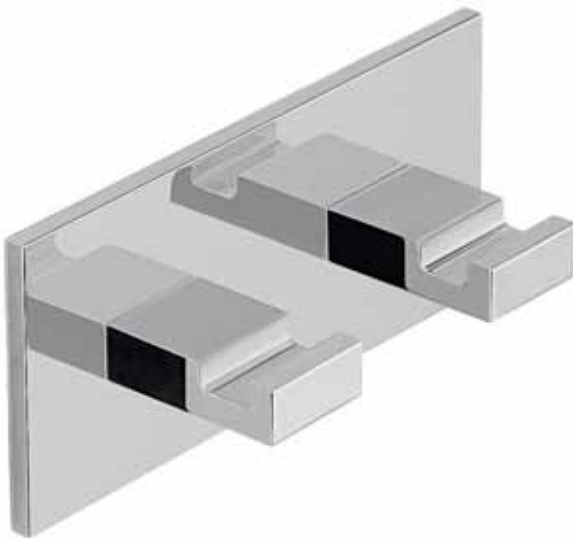

Fissaggio con biadesivo  
Biadhesive fixing

D126

Appendiabiti doppio  
Double hook

11,5 x 4 x 5,3 cm

Crochet double  
Haken doppelt  
Percha doble  
Двойной крючок

G•MALTA

13 Cromato  
Chromed

Realizzati in alluminio - Made of aluminum - Réalisés en aluminium - Hergestellt aus Aluminium - Realizadas en aluminio - Изготовлено из алюминия



A628

Appendiabiti doppio a pinza  
Clip-on double hook

3,5 x 5,9 x 5 cm

Patère double à pince  
Doppelter Kleiderständer  
Percha pinza doble  
Двойная вешалка с зажимами

A626

Appendiabiti  
Hook

3 x 3 x 9 cm

Crochet  
Haken  
Percha  
Крючок



## G•MALDIVE

13 Cromato Chromed

Realizzati in Cromall® - Made of Cromall® - Réalisés en Cromall® - Hergestellt aus Cromall® - Realizadas en Cromall® - Изготовлено из Cromall®



3626

Appendiabiti  
Hook

5,5 x 4,3 x 6,3 cm

Crochet - Haken  
Percha - Крючок

## G•GEA

13 Cromato Chromed

Realizzata in ottone e alluminio - Made of brass and aluminium - Réalisée en laiton et aluminium - Hergestellt aus Messing und Aluminium - Realizada en latón y aluminio - Изготовлено из латуни и алюминия







## A227

Appendiabiti  
Hook

1,8 x 3,5 x 1,8 cm

Crochet  
Haken  
Percha  
Крючок

## A226

Appendiabiti doppio  
Double hook

7 x 3,5 x 1,8 cm

Crochet double  
Haken doppelt  
Percha doble  
Двойной крючок

## A228

Appendiabiti multiplo  
Multiple hook

17,2 x 3,5 x 1,8 cm

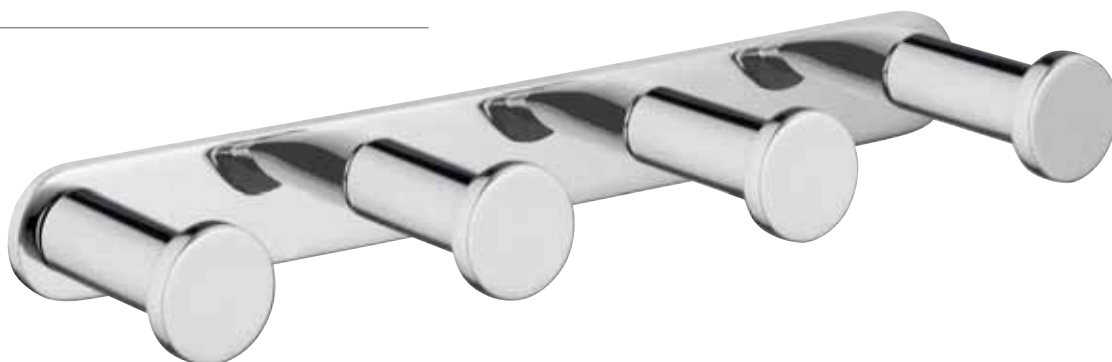
Crochet quatre têtes  
Haken vierfach  
Percha cuádruple  
Мультикрючок

G•CANARIE

13 Cromato  
Chromed

Realizzati in ottone - Made of brass - Réalisés en laiton - Hergestellt aus Messing - Realizados en latón - Изготовлено из латуни



**SO26**

Appendiabiti per box doccia  
Hook for shower shower box  
4 x 4,5 x 8 cm

Crochet pour cabine douche  
Haken für Duschkabinen  
Percha para box ducha  
Крючок для душевой кабины

**SO27**

Appendiabiti  
Hook  
4 x 2,7 x 5,5 cm

Crochet  
Haken  
Percha  
Крючок



**Fissaggio con biadesivo**  
**Biadesive fixing**



**G•EGADI**

**13** Cromato  
Chromed

Realizzati in acciaio inox - Made of stainless steel - Réalisés en inoxydable chromé - Hergestellt aus Edelstahl - Realizados en acero inox  
Хромированная сталь

# ACCESSORI ZONA DOCCIA

Shower and bathtub accessories

Accessoires pour douche et baignoire

Dusch-und Badewannenzubehör

Complementos de ducha y de bañera

Аксессуары для ванной и душа





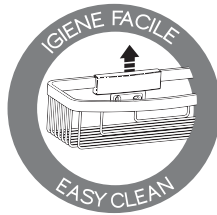

S118

Porta oggetti doccia  
Shower caddy

26,3 x 12,7 x 7,2 cm

Porte-objets  
Duschhalterung  
Portaobjetos  
Полочка для ванны

S180

Porta oggetti doccia  
Shower caddy

19,6 x 19,6 x 7,2 cm



Porte-objets  
Duschhalterung  
Portaobjetos  
Полочка для ванны



G•TOBAGO

13 Cromato  
Chromed

Realizzati in acciaio inox, ottone e Cromall® - Made of chromed stainless steel, brass and Cromall® - Réalisés en acier inoxydable chromé, laiton et Cromall® - Hergestellt aus verchromtem Edelstahl, Messing und Cromall® - Realizados en acero inox cromado, latón y Cromall®  
Изготовлено из нержавеющей стали и латуни и Cromall®



A618

Porta oggetti doccia  
Shower caddy

24,2 x 11,7 x 7,5 cm

Porte-objets  
Duschhalterung  
Portaobjetos  
Полочка для ванны



A680

Portaoggetti angolare  
Corner shower caddy

19 x 19 x 7,5 cm

Porte-objets d'angle  
Eckhalterung  
Portaobjetos angular  
Угловая мыльница

G•MALDIVE



Realizzati in Cromall® e resine termoplastiche - Made of Cromall® and thermoplastic resins - Réalisés en Cromall® et thermoplastique  
Hergerstellt aus Cromall® und Kunststoff - Realizados en Cromall® y resinas termoplásticas - Изготовлено из Cromall® и термопластичных смол

S218

Porta oggetti doccia  
Shower caddy

27 x 13 x 7,8 cm



Porte-objets  
Duschhalterung  
Portaobjetos  
Полочка для ванны



S282

Porta oggetti doccia  
Shower caddy

27 x 13 x 5,8 cm

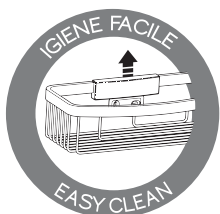

Porte-objets  
Duschhalterung  
Portaobjetos  
Полочка для ванны



G•BARBADOS

13 Cromato  
Chromed

Realizzati in ottone e Cromall® - Made of brass and Cromall® - Réalisés en laiton et Cromall® - Hergestellt aus Messing und Cromall®  
Realizados en latón y Cromall® - Изготовлено из меди и Cromall®



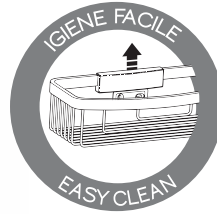
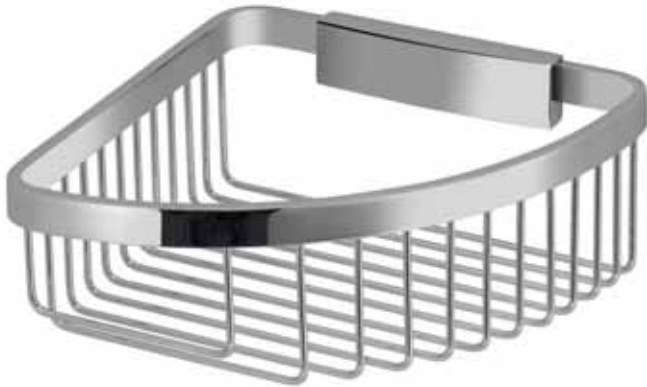
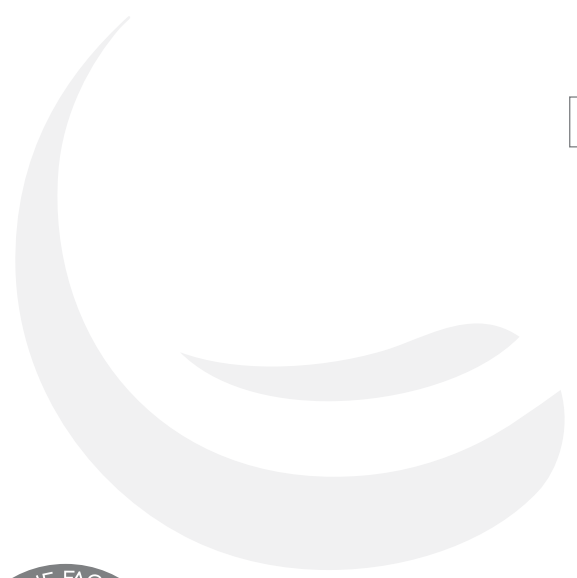

**S283**

Portaoggetti angolare  
Corner shower caddy

19 x 19 x 7,8 cm

Porte-objets d'angle  
Eckhalterung  
Portaobjetos angular  
Угловая мыльница

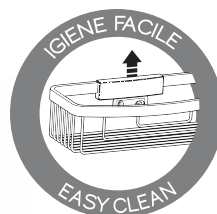

**S280**

Portaoggetti angolare  
Corner shower caddy

19 x 19 x 5,8 cm

Porte-objets d'angle  
Eckhalterung  
Portaobjetos angular  
Угловая мыльница



## S018

Porta oggetti doccia  
Shower caddy

26 x 13 x 7,5 cm

Porte-objets  
Duschhalterung  
Portaobjetos  
Полочка для ванны

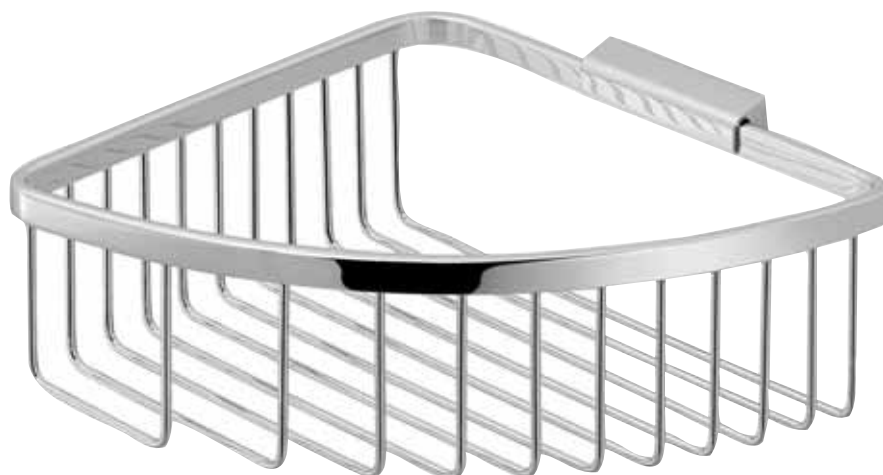
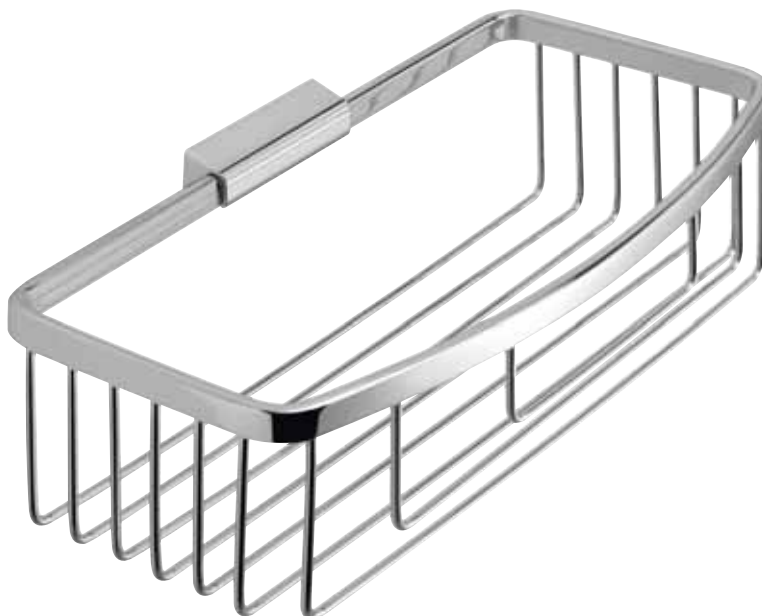

## S080

Porta oggetti doccia  
Shower caddy

19,5 x 19,5 x 7,5 cm

Porte-objets  
Duschhalterung  
Portaobjetos  
Полочка для ванны

G•TRINIDAD

Realizzati in acciaio inox - Made of stainless steel - Réalisés en acier inoxydable - Hergestellt aus Edelstahl - Realizados en acero inox  
Изготовлено из нержавеющей стали

13 Cromato  
Chromed

**SO41**

Tergivetro  
Wiper-blade  
25 x 2,5 x 17 cm

Raclette de douche  
Glasabzieher  
Limpiacristales  
Стеклоочиститель

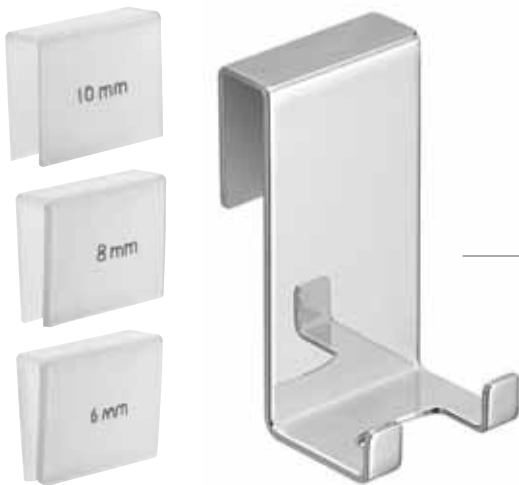
**SO26**

Supporto per SO41  
Support for SO41

4 x 4,5 x 8 cm

Crochet amovible pour SO41  
Unterstützung für SO41  
Soporte para SO41  
Поддержка для SO41

**SO27**

Supporto per SO41  
Support for SO41

4 x 2,7 x 5,5 cm

Crochet à fixer pour SO41  
Unterstützung für SO41  
Soporte SO41  
Поддержка для SO41



Fissaggio con biadesivo  
Biadhesive fixing



**G•EGADI**

**13** Cromato  
Chromed

Realizzati in acciaio inox - Made of stainless steel - Réalisés en acier inoxydable - Hergestellt aus Edelstahl - Realizados en acero inox  
Изготовлено из нержавеющей стали

## A681

Distributore sapone  
Soap dispenser

7 x 8,6 x 23,8 cm - 200 ml

Distributeur de savon  
Seifenspender  
Dosificador de jabón  
Ёмкость для жидкого мыл

## A682

Distributore sapone  
Soap dispenser

5,5 x 7,1 x 21,6 cm - 350 ml

Distributeur de savon  
Seifenspender  
Dosificador de jabón  
Дозатор для жидкого мыла



RETAIL



Guardare alle cose usuali  
con occhi differenti.

Look at usual things  
with unusual eyes.





# Indice RETAIL

wall fittings serie da muro

G•ATENA pagina 120

G•EROS pagina 134

G•FEBO pagina 126

G•KARMA pagina 114

table top oggettistica d'appoggio

G•AFRODITE pagina 148

G•CALIPSO pagina 144

G•DAFNE pagina 150

G•GIUNONE pagina 146

G•ISIDE pagina 154

G•MINERVA pagina 158

G•MITRA pagina 156

G•NINFEA pagina 152

G•TINA pagina 142

mirrors specchi pagina 160

bathroom accessories accessori zona wc

e complementi pagina 166

shower and bathtub accessories accessori zona doccia pagina 180

# G•KARMA

design  
Piet Billekens









3510

Portaspazzolini  
Toothbrush holder

8 x 12 x 11,5 cm

Porte brosse à dents  
Zahnbürstenhalter  
Portacepillos  
Стакан для зубных щёток



3511

Portasapone  
Soap holder

14 x 14,5 x 9,5 cm

Porte savon  
Seifenschale  
Jabonera  
Мыльница

3581

Dosasapone  
Soap dispenser

8 x 12 x 16,5 cm

Distributeur de savon  
Seifenspender  
Dosificador de jabón  
Дозатор для жидкого мыла



**G•KARMA** design Piet Billekens

02

Cromato con  
ceramica lucida  
Chromed with glossy  
pottery containers

13

Cromato  
Chromed

Realizzata in ottone e Cromall® con contenitori in ceramica - Made of brass and Cromall® with pottery containers - Réalisée en laiton et Cromall® avec boîtiers en céramique - Hergestellt aus Messing und Cromall® mit Behältern aus Keramik - Realizada en latón y Cromall® con contenedores en cerámica - Изготовлено из латуни и Cromall® с ёмкостями из керамики

3521-30

Portasalviette

Towel holder

30 x 8,5 x 10,7 cm

Porte serviette - Handtuchhalter  
Toallero - Полотенцедержатель



3521-45

Portasalviette

Towel holder

45 x 8,5 x 10,7 cm

Porte serviette  
Handtuchhalter  
Toallero  
Полотенцедержатель

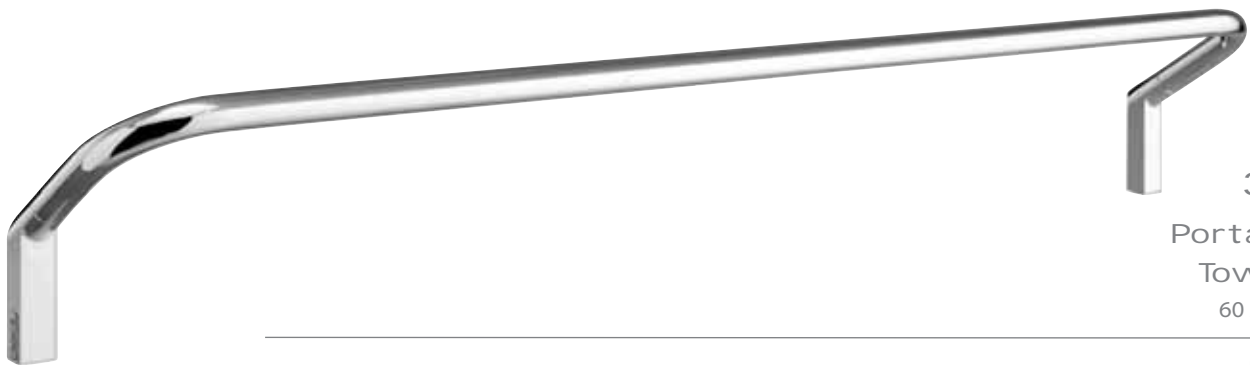

3521-60

Portasalviette

Towel holder

60 x 8,5 x 10,7 cm

Porte serviette  
Handtuchhalter  
Toallero  
Полотенцедержатель

3523

Portasalvietta a snodo  
Jointed towel holder

33 x 4,5 x 9 cm

Porte serviette réglable  
Handtuchhalter schwenkbar  
Toallero articulado  
Полотенцедержатель  
на шарнирах



3524

Portarotolo  
Toilet paper holder

14,5 x 8 x 9,5 cm

Porte rouleau  
Papierrollenhalter  
Portarrollos  
Бумагодержатель

3527

Appendiabiti  
Hook

1,4 x 3 x 8,8 cm

Crochet  
Haken  
Percha  
Крючок



3570

Portasalvietta  
ad anello  
Towel ring  
19 x 8 x 12,4 cm

Anneau porte serviette  
Handtuchring  
Toallero argolla  
Полотенцедержатель  
"кольцо"

3533

Scopino WC con ciuffo in setole  
Toilet brush holder with bristle brush

ø 10 x 38,2 cm

Porte balai avec brosse en nylon  
WC-Bürstengarnitur mit Borsten-Aufsatz  
Escobillero con escobilla de nylon  
Туалетный ёршик с нейлоновой щетиной



3533-03

Scopino WC da muro con ciuffo in setole  
Wall toilet brush holder with bristle brush

10 x 14 x 38 cm

Porte brosse mural avec brosse en nylon  
WC-Bürstengarnitur mit Borsten-Aufsatz mit Wandhalterung  
Escobillero de pared con escobilla de nylon  
Настенный туалетный ёршик с нейлоновой щеткой

# G•ATENA



## FISSABILE ANCHE CON COLLA (VENDUTA A PARTE)

Can be fixed with glue (sold separately)  
Peut être fixé avec de la colle  
(vendu séparément)  
Kann mit Kleber fixiert werden  
(separat erhältlich)  
Может быть закреплен клеем  
(продается отдельно)





4410

Portaspazzolini  
Toothbrush holder

8,1 x 10 x 10,7 cm

Porte brosse à dents  
Zahnbürstenhalter  
Portacepillos  
Стакан для зубных щёток



4411

Portasapone  
Soap holder

11,5 x 10 x 3,9 cm

Porte savon  
Seifenschale  
Jabonera  
Мыльница

4481

Dosasapone  
Soap dispenser

8,1 x 11,1 x 16,4 cm

Distributeur de savon  
Seifenspender  
Dosificador de jabón  
Диспенсер для жидкого мыла



4421-30

Portasalviette  
Towel holder

35 x 5,6 x 3,5 cm

Porte serviette  
Handtuchhalter  
Toallero  
Полотенцедержатель



4421-45

Portasalviette  
Towel holder

45 x 5,6 x 3,5 cm

Porte serviette  
Handtuchhalter  
Toallero  
Полотенцедержатель

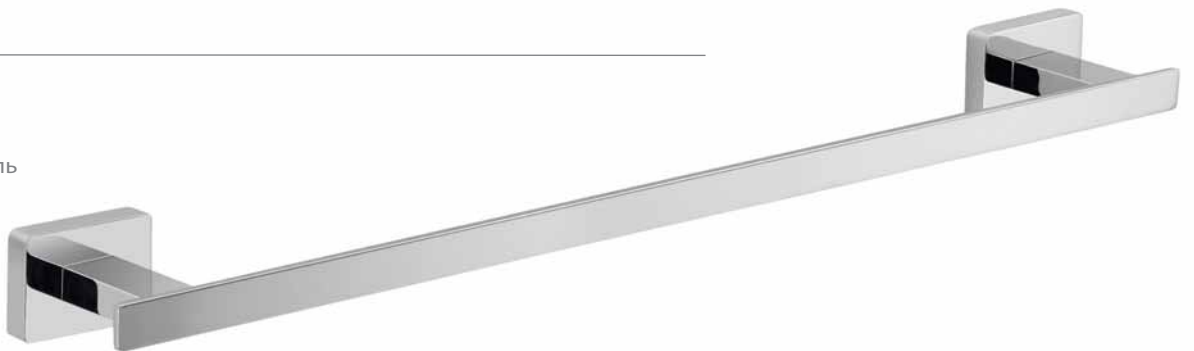

4421-60

Portasalviette  
Towel holder

60 x 5,6 x 3,5 cm

Porte serviette  
Handtuchhalter  
Toallero  
Полотенцедержатель



4424

Portarotolo  
Toilet paper  
holder

19 x 6,4 x 3,5 cm

Porte rouleau  
Papierrollenhalter  
Portarrollos  
Бумагодержатель



4426

Appendiabiti doppio  
Double hook

8,8 x 4,5 x 3,5 cm

Crochet double  
Haken doppelt  
Percha doble  
Двойной крючок

4470

Portasalviette ad anello  
Towel ring

22,5 x 5,6 x 14,5 cm

Anneau porte serviette  
Handtuchring  
Toallero argolla  
Полотенцедержатель "кольцо"





**4425**  
**Portarotolo coperto**  
**Toilet paper holder with cover**  
 13 x 5,3 x 11,3 cm

Porte rouleau avec couvercle  
 Papierrollenhalter mit Deckel  
 Portarrollos con tapa  
 Бумагодержатель с крышкой

**4433-03**

**Scopino WC da muro con ciuffo in setole**  
**Wall toilet brush holder with bristle brush**  
 10,2 x 12 x 37,5 cm

Porte balai mural avec brosse en nylon  
 Bürstengarnitur mit Borsten-Aufsatz mit Wandhalterung  
 Escobillero de pared con escobilla de nylon  
 Настенный туалетный ёршик с нейлоновой щетиной



# G•FEBO



## FISSABILE ANCHE CON COLLA (VENDUTA A PARTE)

Can be fixed with glue (sold separately)  
Peut être fixé avec de la colle  
(vendu séparément)  
Kann mit Kleber fixiert werden  
(separat erhältlich)  
Может быть закреплен клеем  
(продается отдельно)





5310

Portaspazzolini  
Toothbrush holder  
6,8 x 10 x 10,5 cm

Porte brosse à dents  
Zahnbürstenhalter  
Portacepillos  
Стакан для зубных щёток



5311

Portasapone  
Soap holder  
10,8 x 11,9 x 7 cm

Porte savon  
Seifenschale  
Jabonera  
Мыльница



5381

Dosasapone  
Soap dispenser  
6,8 x 10 x 15,9 cm

Distributeur de savon  
Seifenspender  
Dosificador de jabón  
Дозатор для жидкого мыла



5319-60

Mensola  
Shelf  
60 x 14,5 x 7 cm



Étagère - Ablage  
Estante - Полочка

Vetro temperato  
Tempered glass  
Verre tempéré  
Sekuritglas  
Cristal templado  
из закаленного стекла

fissaggio solo con viti  
to be fixed with screws



G•FEBO

13 Cromato  
Chromed

Realizzata in acciaio inox e Cromall® con contenitori in vetro satinato - Made of stainless steel and Cromall® with frosted glass containers  
Réalisée en acier inoxydable et Cromall® avec boîtiers en verre satiné - Hergestellt aus Edelstahl und Cromall® mit Behältern aus satiniertem Glas - Realizada en acero inoxidable y Cromall® con contenedores en cristal satinado - Изготовлено из нержавеющей стали и Cromall® с ёмкостями из матового стекла

5321-35

Portasalviette  
Towel holder

35 x 7 x 7 cm

Porte serviette - Handtuchhalter  
Toallero - Полотенцедержатель

5321-45

Portasalviette  
Towel holder

45 x 7 x 7 cm

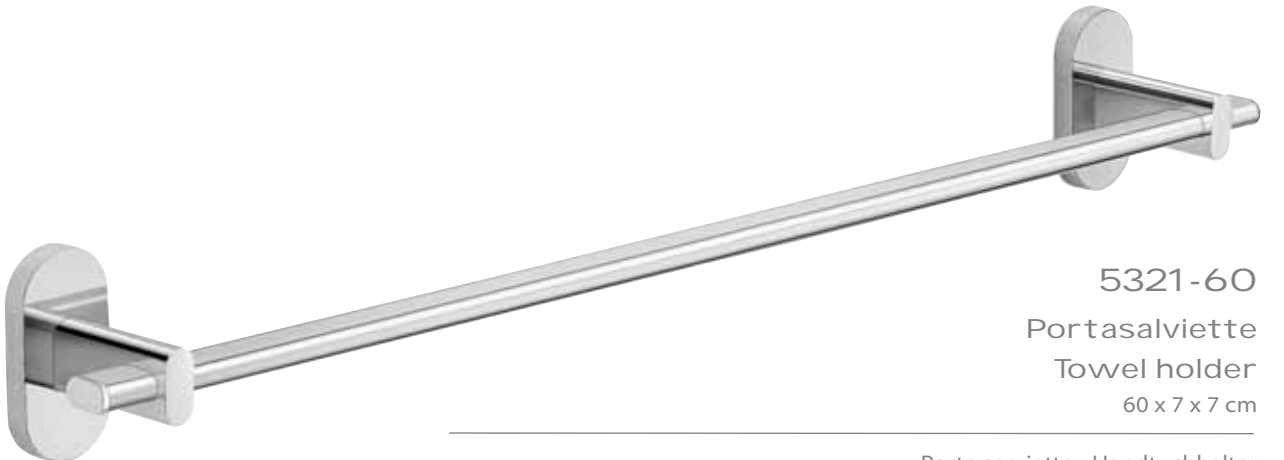
Porte serviette  
Handtuchhalter  
Toallero  
Полотенцедержатель

5321-60

Portasalviette  
Towel holder

60 x 7 x 7 cm

Porte serviette - Handtuchhalter  
Toallero - Полотенцедержатель

5370

Portasalviette ad anello

Towel ring

23 x 7 x 17,9 cm

Anneau porte serviette

Handtuchring

Toallero argolla

Полотенцедержатель "кольцо"



5326

Appendiabiti doppio

Double hook

8,5 x 7 x 7 cm

Crochet double

Haken doppelt

Percha doble

Двойной крючок



5323

Portasalviette a snodo

Jointed towel holder

35 x 4,8 x 9,8 cm

Porte serviette réglable

Handtuchhalter schwenkbar

Toallero articulado

Полотенцедержатель на шарнирах

fissaggio solo con viti  
to be fixed with screws





5329  
Portarotolo doppio  
Double toilet paper holder  
26,6 x 7 x 7 cm

Porte rouleau double  
Papierrollenhalter doppelt  
Portarrollos doble  
Двойной бумагодержатель

5324  
Portarotolo  
Toilet paper holder  
16 x 7 x 7 cm

Porte rouleau  
Papierrollenhalter  
Portarrollos  
Бумагодержатель





5325

Portarotolo coperto  
Toilet paper holder with cover

16,3 x 8 x 14,3 cm

Porte rouleau avec couvercle  
Papierrollenhalter mit Deckel  
Portarrollos con tapa  
Бумагодержатель с крышкой

5333-03

Scopino WC da muro con ciuffo in setole  
Wall toilet brush holder with bristle brush  
8,5 x 12 x 36,6 cm

Porte balai à mur avec brosse en nylon  
Bürstengarnitur mit Borsten-Aufsatz mit Wandhalterung  
Escobillero de pared con escobilla de nylon  
Настенный туалетный ёршик с нейлоновой щетиной



5344

Mensola portasciugamani

Shelf for towels

52,4 x 25,2 x 7 cm

Étagère porte serviettes  
 Handtuchablage  
 Estante para toallas  
 Полочка для полотенец

fissaggio solo con viti  
 to be fixed with screws

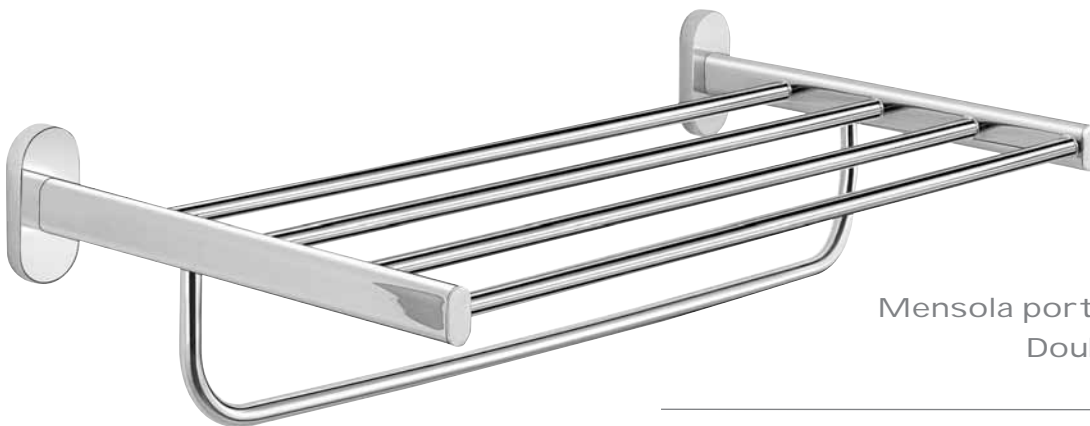
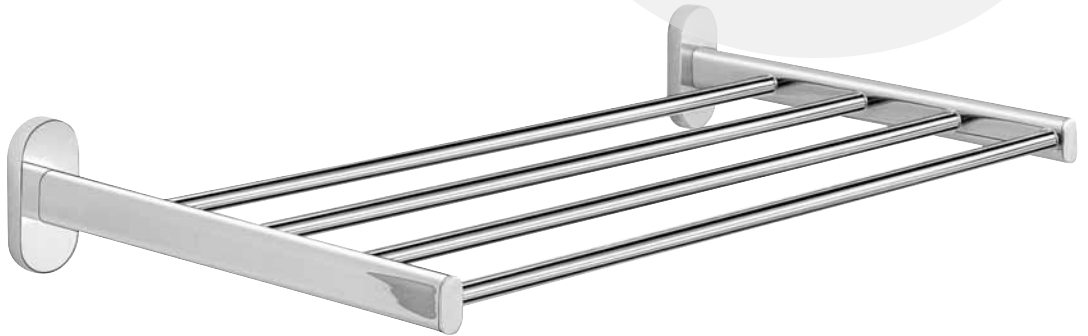

5335

Mensola portasciugamani doppia

Double shelf for towels

52,4 x 25,2 x 12 cm

Étagère double porte serviettes  
 Handtuchablage doppelt  
 Estante doble para toallas  
 Полочка для полотенец

fissaggio solo con viti  
 to be fixed with screws

# G•EROS



## FISSABILE ANCHE CON COLLA (VENDUTA A PARTE)

Can be fixed with glue (sold separately)  
Peut être fixé avec de la colle  
(vendu séparément)  
Kann mit Kleber fixiert werden  
(separat erhältlich)  
Может быть закреплен клеем  
(продается отдельно)





2310

Portaspazzolini  
Toothbrush holder

6,8 x 10,7 x 9,6 cm

Porte brosse à dents  
Zahnbürstenhalter  
Portacepillos  
Стакан для зубных щёток



2311

Portasapone  
Soap holder

10,8 x 12,5 x 5,6 cm

Porte savon  
Seifenschale  
Jabonera  
Мыльница



2381

Dosasapone  
Soap dispenser

6,8 x 10,7 x 15,9 cm

Distributeur de savon  
Seifenspender  
Dosificador de jabón  
Дозатор для жидкого мыла



2319-60

Mensola  
Shelf

60 x 14,4 x 5 cm

Étagère - Ablage  
Estante - Полочка

Vetro temperato  
Tempered glass  
Verre tempéré  
Sekuritglas  
Cristal templado  
из закаленного стекла

fissaggio solo con viti  
to be fixed with screws

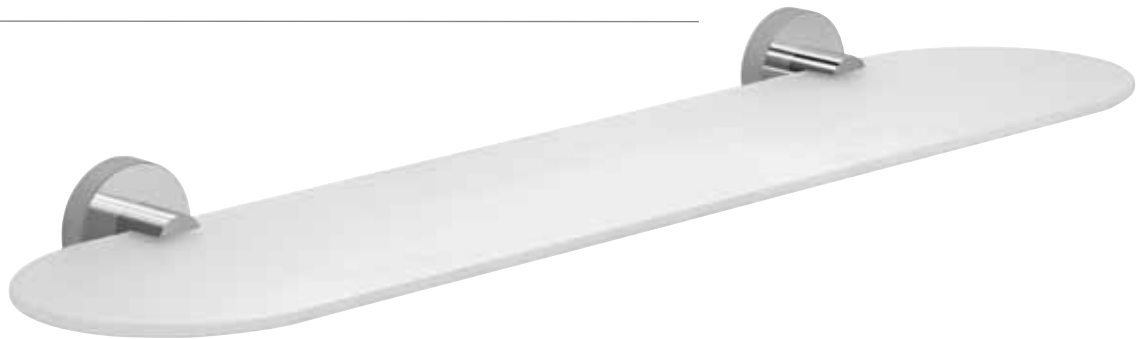

G•EROS

13 Cromato  
Chromed

NEW

14 Nero matt  
Matt black

Realizzata in acciaio inox e Cromall® con contenitori in vetro satinato - Made of stainless steel and Cromall® with frosted glass containers  
Réalisée en acier inoxydable et Cromall® avec boîtiers en verre satiné - Hergestellt aus Edelstahl und Cromall® mit Behältern aus satiniertem Glas - Realizada en acero inoxidable y Cromall® con contenedores en cristal satinado - Изготовлено из нержавеющей стали и Cromall® с ёмкостями из матового стекла

2321-35

Portasalviette

Towel holder

35 x 7,6 x 5 cm

Porte serviette - Handtuchhalter  
Toallero - Полотенцедержатель



2321-45

Portasalviette

Towel holder

45 x 7,6 x 5 cm

Porte serviette  
Handtuchhalter  
Toallero  
Полотенцедержатель



2321-60

Portasalviette

Towel holder

60 x 7,6 x 5 cm

Porte serviette - Handtuchhalter  
Toallero - Полотенцедержатель



2370

Portasalviette ad  
anello

Towel ring

20,5 x 4,2 x 16,7 cm

Anneau porte serviette  
Handtuchring  
Toallero argolla  
Полотенцедержатель "кольцо"





2323

Portasalviette  
a snodo  
Jointed towel  
holder

35 x 4,5 x 6 cm

Porte serviette réglable  
Handtuchhalter schwenkbar  
Toallero articulado  
Полотенцедержатель на шарнирах

fissaggio solo con viti  
to be fixed with screws



2355

Porta asciugacapelli  
Hairdryer support

9,5 x 12,5 x 17 cm

Support sèche-cheveux  
Haartrocknerhalter  
Soporte para secador de pelo  
Держатель для фена



2326

Appendiabiti doppio  
Double hook

7 x 4,6 x 5 cm

Crochet double - Haken doppelt  
Percha doble - Двойной крючок





2324  
Portarotolo  
Toilet paper holder  
16 x 7,6 x 5 cm

Porte rouleau  
Papierrollenhalter  
Portarrollos  
Бумагодержатель

2325

Portarotolo coperto  
Toilet paper holder with cover  
13,5 x 5,2 x 13,6 cm

Porte rouleau avec couvercle  
Papierrollenhalter mit Deckel  
Portarrollos con tapa  
Бумагодержатель с крышкой



2333-03

Scopino WC da muro con ciuffo in setole  
Wall toilet brush holder with bristle brush  
8,5 x 12 x 36,6 cm

Porte balai mural avec brosse en nylon  
Bürstengarnitur mit Borsten-Aufsatz mit Wandhalterung  
Escobillero de pared con escobilla de nylon  
Настенный туалетный с нейлоновой щетиной



# OGGETTISTICA D'APPOGGIO

Table top lines  
Accessoires à poser  
Badausstattung  
Serie de apoyo  
Настольные аксессуары









6898

Portaspazzolini - Toothbrush holder holder

Porte brosse à dents - Zahnbürstenhalter  
 Portacepillos - Стакан для зубных щёток  
 9,2 x 6,3 x 11,2 cm

6811

Portasapone - Soap holder

Porte savon - Seifenschale - Jabonera - Мыльница  
 14,7 x 10,7 x 2,5 cm

6881

Dosasapone - Soap dispenser

Distributeur de savon - Seifenspender  
 Dosificador de jabón - Дозатор для жидкого мыла  
 9 x 6,5 x 16 cm

6833

Scopino WC - Toilet brush

Porte-brosse WC - WC-Bürstengarnitur  
 Escobillero - Туалетный ёршик  
 10,5 x 7,5 x 39 cm



G•TINA

Realizzata in acciaio inox - Made of stainless steel - Réalisé en acier inoxydable - Hergestellt aus Edelstahl  
 Realizada en acero inox - Изготовлено из нержавеющей стали





8798

Portaspazzolini - Toothbrush holder

Porte brosse à dents - Zahnbürstenhalter  
 Portacepillos - Стакан для зубных щёток  
 ø 7,7 x 11,3 cm

8711

Portasapone - Soap holder

Porte savon - Seifenschale - Jabonera - Мыльница  
 11,8 x 7,5 x 2,6 cm

8780

Dosasapone - Soap dispenser

Distributeur de savon - Seifenspender  
 Dosificador de jabón - Дозатор для жидкого мыла  
 ø 8,2 x 17,6 cm

8733

Scopino WC - Toilet brush

Porte-brosse WC - WC-Bürstengarnitur  
 Escobillero - Туалетный ёршик  
 ø 10 x 48,7 cm



G•CALIPSO

08 Grigio Grey

Realizzata in cemento - Made of concrete - Réalisé en béton - Hergestellt aus Zement - Realizada en cemento - Изготовлено из бетона



4198

Portaspazzolini - Toothbrush holder

Porte brosse à dents - Zahnbürstenhalter

Portacepillos - Стакан для зубных щёток

ø 8,2 x 9,3 cm

4111

Portasapone - Soap holder

Porte savon - Seifenschale - Jabonera - Мыльница

ø 11,5 x 2,4 cm

4180

Dosasapone - Soap dispenser

Distributeur de savon - Seifenspender

Dosificador de jabón - Дозатор для жидкого мыла

ø 8,2 x 17,5 cm

4133

Scopino WC - Toilet brush

Porte-brosse WC - WC-Bürstengarnitur

Escobillero - Туалетный ёршик

ø 10,3 x 46,5 cm

4106

Vassoio portaoggetti - Tray

Plateau porte-objets - Tablett - Bandeja portaobjetos

Полочка для ваннных принадлежностей

27,5 x 15,5 x 2,8 cm



G•GIUNONE

08

Grigio  
Grey

Realizzata in cemento - Made of concrete - Réalisé en béton - Hergestellt aus Zement - Realizada en cemento - Изготовлено из бетона



4998

Portaspazzolini - Toothbrush holder

Porte brosse à dents - Zahnbürstenhalter  
 Portacepillos - Стакан для зубных щёток  
 ø 7,5 x 11,5 cm

4911

Portasapone - Soap holder

Porte savon - Seifenschale - Jabonera - Мыльница  
 12,8 x 8,4 x 3 cm

4980

Dosasapone - Soap dispenser

Distributeur de savon - Seifenspender  
 Dosificador de jabón - Дозатор для жидкого мыла  
 ø 7,6 x 17,2 cm

4933

Scopino WC - Toilet brush

Porte-brosse WC - WC-Bürstengarnitur  
 Escobillero - Туалетный ёршик  
 ø 9,3 x 47 cm

4906

Vassoio portaoggetti - Tray

Plateau porte-objets - Tablett - Bandeja portaobjetos  
 Полочка для ваннных принадлежностей  
 30,5 x 10,4 x 3,2 cm



G•AFRODITE

08 Grigio Grey

Realizzata in cemento/bambù - Made of concrete/bamboo - Réalisé en béton/bambou - Hergestellt aus Zement/Bambus - Realizada en cemento/bambú - Изготовлено из бетона/бамбука





3998

Portaspazzolini - Toothbrush holder

Porte brosse à dents - Zahnbürstenhalter  
 Portacepillos - Стакан для зубных щёток  
 8 x 8 x 13 cm

3911

Portasapone - Soap holder

Porte savon - Seifenschale - Jabonera - Мыльница  
 14 x 8 x 2,2 cm

3980

Dosasapone - Soap dispenser

Distributeur de savon - Seifenspender  
 Dosificador de jabón - Дозатор для жидкого мыла  
 8 x 8 x 18,5 cm

3933

Scopino WC - Toilet brush

Porte-brosse WC - WC-Bürstengarnitur  
 Escobillero - Туалетный ёршик  
 9,5 x 9,5 x 47 cm



G•DAFNE

30 Noce  
Walnut  
colour

Realizzata in bambù - Made of bamboo - Réalisé en bambou - Hergestellt aus Bambus - Realizada en bambú - Изготовлено из бамбука





1398

Portaspazzolini - Toothbrush holder

Porte brosse à dents - Zahnbürstenhalter  
 Portacepillos - Стакан для зубных щёток  
 12,8 x 5,6 x 8,5 cm

1311

Portasapone - Soap holder

Porte savon - Seifenschale - Jabonera - Мыльница  
 12,8 x 8,2 x 3 cm

1380

Dosasapone - Soap dispenser

Distributeur de savon - Seifenspender  
 Dosificador de jabón - Дозатор для жидкого мыла  
 12,8 x 5,6 x 15,7 cm

1333

Scopino WC - Toilet brush

Porte-brosse WC - WC-Bürstengarnitur  
 Escobillero - Туалетный ёршик  
 9,3 x 9,3 x 46,2 cm

1306

Vassoio portaoggetti - Tray

Plateau porte-objets - Tablett - Bandeja portaobjetos  
 Полочка для ваннных принадлежностей  
 29,7 x 15,2 x 2 cm

35

Bambù  
 Bamboo



G•NINFEA

02

Bianco  
 White

Realizzata in resina/bambù - Made of resin/bamboo - Réalisé en résine/bambou - Hergestellt aus Harz/Bambus - Realizada en resina/bambú  
 Изготовлено из смол/бамбука



1898

Portaspazzolini - Toothbrush holder

Porte brosse à dents - Zahnbürstenhalter

Portacepillos - Стакан для зубных щёток

ø 8,2 x 8 x 13,2 cm

1811

Portasapone - Soap holder

Porte savon - Seifenschale - Jabonera - Мыльница

15,2 x 11,5 x 2,9 cm

1881

Dosasapone - Soap dispenser

Distributeur de savon - Seifenspender

Dosificador de jabón - Дозатор для жидкого мыла

8,5 x 9,1 x 16,3 cm

1833

Scopino WC - Toilet brush

Porte-brosse WC - WC-Bürstengarnitur

Escobillero - Туалетный ёршик

12 x 11,6 x 45,8 cm

Novità - New

155



G•ISIDE

02

Bianco  
White

14

Nero matt  
Matt black

Realizzata in resina - Made of resin - Réalisé en résine - Hergestellt aus Harz - Realizada en resina - Изготовлено из песка

02

Realizzata in resina e sabbia - Made of resin and sand - Réalisé en résine et sable - Hergestellt aus Harz und Sand  
Realizada en resina y arena - Изготовлено из смол и песка

14





1998

Portaspazzolini - Toothbrush holder

Porte brosse à dents - Zahnbürstenhalter

Portacepillos - Стакан для зубных щёток

ø 10,5 x 10,5 cm

1911

Portasapone - Soap holder

Porte savon - Seifenschale - Jabonera - Мыльница

ø 12 x 2,5 cm

1980

Dosasapone - Soap dispenser

Distributeur de savon - Seifenspender

Dosificador de jabón - Ёмкость для жидкого мыла

ø 10,5 x 15 cm

1985

Dosasapone - Soap dispenser

Distributeur de savon - Seifenspender

Dosificador de jabón - Дозатор для жидкого мыла

ø 14,5 x 11 cm

1933

Scopino WC - Toilet brush

Porte-brosse WC - WC-Bürstengarnitur

Escobillero - Туалетный ёршик

ø 13,5 x 47 cm



G•MITRA

03

Beige  
Beige

Realizzata in resina e sabbia - Made of resin and sand - Réalisé en résine et sable - Hergestellt aus Harz und Sand - Realizada en resina y arena  
 Изготовлено из смол и песка







1298

Portaspazzolini - Toothbrush holder

Porte brosse à dents - Zahnbürstenhalter  
 Portacepillos - Стакан для зубных щёток  
 7,4 x 7,4 x 11,7 cm

1211

Portasapone - Soap holder

Porte savon - Seifenschale - Jabonera - Мыльница  
 12,6 x 8,5 x 2 cm

1280

Dosasapone - Soap dispenser

Distributeur de savon - Seifenspender  
 Dosificador de jabón - Дозатор для жидкого мыла  
 7,4 x 7,4 x 15,2 cm

1233

Scopino WC - Toilet brush

Porte-brosse WC - WC-Bürstengarnitur  
 Escobillero - Туалетный ёршик  
 9,6 x 9,6 x 46,6 cm



G•MINERVA

03

Beige  
Beige

85

Antracite  
Anthracite

Realizzata in resina e sabbia - Made of resin and sand - Réalisé en résine et sable - Hergestellt aus Harz und Sand - Realizada en resina y arena  
 Изготовлено из смол и песка

# SPECCHI E SPECCHI INGRANDITORI

Mirrors and magnifying mirrors

Miroirs grossissants et miroirs

Vergrößerungsspiegel und Spiegel

Espejos de aumento e espejos

Увеличительные зеркала и зеркала





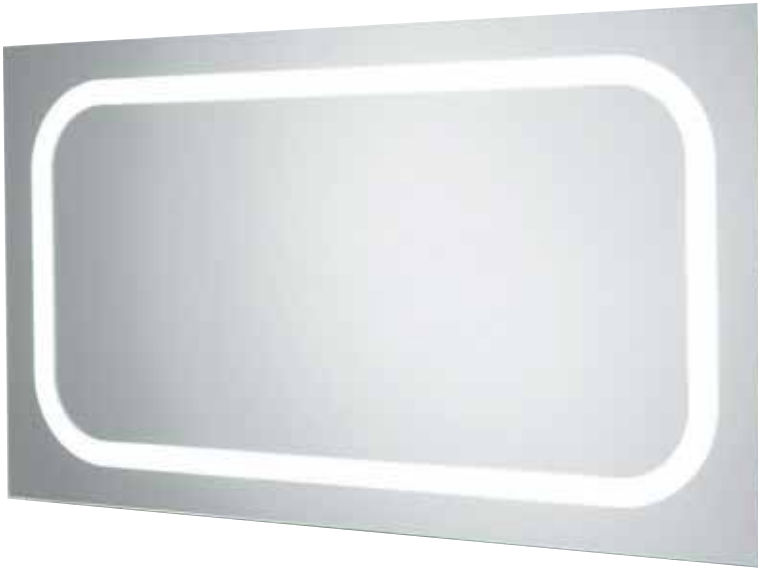

## 2582 G•RAFAL

Design: Anna Deplano

Specchio retroilluminato

Backlighting mirror

100 x 4,6 x 57,5 cm

Miroir rétroéclairé  
Spiegel mit Rückbeleuchtung  
Espejo retroiluminado  
Зеркало с тыльной подсветкой

CE

IP 44 

2xT9 - W40



## 2590

Specchio con lastra infrangibile

Mirror with shatterproof surface

60 x 2,5 x 70 cm

Miroir infrangible  
Bruchsicherer Spiegel  
Espejo irrompible  
Зеркало небьющееся

acciaio inox - stainless steel  
acier inox - Edelstahl - нержавеющей сталь

Montabile anche in posizione orizzontale  
can be mounted horizontally  
Montable aussi en position horizontale  
Kann auch quer aufgehängt werden  
Puede montarse también horizontalmente  
Монтируется и горизонтальном положении

100%  
made in Italy



13 Super Mirror



## 2597 G•PLANET

Design: Anna Deplano

Specchio con bordo inciso  
Mirror with engraved edge

100 x 2 x 57,5 cm

Spiegel mit geätztem Rand  
Espejo con borde grabado  
Зеркало с гравированной окантовкой

Montabile anche in posizione verticale  
Upright mountable also  
Montable aussi en position verticale  
Kann auch hoch aufgehängt werden  
Montable verticalmente también  
Монтируется и вертикальном положении

100%  
made in Italy



## 2596 G•IRIDIUM

Specchio sabbiato  
Mirror with sandblasted frame

70 x 2 x 70 cm

Miroir sablé  
Spiegel mit mattem Rahmen  
Espejo con marco arenado  
Зеркало в шлифованной рамке

100%  
made in Italy





2 x

## 2105 G•LAURENT

Specchio ingranditore  
con luce

Magnifying mirror  
with light

ø 19 cm

Miroir grossissants avec éclairage  
Kosmetikspiegel mit Beleuchtung  
Espejo de aumento con luz  
Увеличительное зеркало с подсветкой

ottone/metallo - brass/metal  
laiton/métal - Messing/Metall  
latón/metal - латунь/металл

CE

IP 44 

W25 - E14

**13** Cromato  
Chromed



2 x

## 2104 G•MICHEL

Specchio ingranditore e non  
Magnifying and not magnifying

ø 23,5 cm

Grossissant et non grossissant  
Magnifying and non-magnifying mirror  
De aumento y normal  
Двустороннее увеличительное  
и обычное зеркало

ottone - brass  
laiton - Messing - латунь

**13** Cromato  
Chromed



2 x

## 2111 G•BERTRAND

Specchio ingranditore  
Magnifying mirror

15 x 20 x 15 cm

Mirror grossissant  
Kosmetikspiegel  
Espejo de aumento  
Увеличительное зеркало

ottone/metallo - brass/metal  
laiton/métal - Messing/Metall  
latón/metal - латунь/металл

100%  
made in Italy

13 Cromato  
Chromed



# ACCESSORI ZONA WC E COMPLEMENTI

Bathroom accessories  
Accessoires pour wc et compléments  
WC-Ausstattung und sonstiges Zubehör  
Complementos para wc y artículos de decoración  
Комплектующие для туалетной комнаты  
и декоративные аксессуары









## G•VESTA

5209

Gettacarta - l. 6,6  
Waste basket - l. 6,6  
ø18,8 x 25 cm

13 Lucido  
Polished

Poubelle de salle de bain - l. 6,6  
Papierkorb - l. 6,6  
Papelera - l. 6,6  
Ненужные ящики - l. 6,6

acciaio inox - stainless steel  
acier inox - Edelstahl  
нержавеющая сталь

5309

Design: Carlo Vietri

Gettacarta - l. 9  
Waste basket - l. 9  
ø 20 x 28,5 cm

Poubelle de salle de bain - l. 9  
Papierkorb - l. 9  
Papelera - l. 9  
Урна для бумаги - l. 9

acciaio inox - stainless steel  
acier inox - Edelstahl - нержавеющая сталь

13 Lucido  
Polished



## CESTINI

Waste bins - Poubelles - Papierkorb - Papeleras - Урна для бумаги

## 2433-03

Scopino WC con ciuffo in setole  
da terra e da muro  
Toilet brush with bristle brush  
floor standing or wall mounted

ø 8 x 35,5 cm

13 Lucido  
Polished

Porte balai WC avec brosse en nylon - à poser et mural  
WC-Bürstengarnitur mit Borsten-Aufsatz  
Zum Aufstellen oder Aufhängen  
Escobillero con escobilla de nylon  
de suelo y pared  
Туалетный ёршик с нейлоновой щетиной

Ottone  
Brass  
Laiton  
Messing  
Latón  
Латунь



13 Cromato  
Chromed

## G•MERCURIO

3633

Scopino WC con ciuffo in setole  
Toilet brush with bristle brush

ø 8,3 x 33,6 cm

Porte balai WC avec brosse en nylon  
WC-Bürstengarnitur mit Borsten-Aufsatz  
Escobillero con escobilla de nylon  
Туалетный ёршик с нейлоновой щетиной

Acciaio inox  
Stainless steel  
Acier inoxydable  
Edelstahl  
Acero inox  
Нержавеющая сталь

## SCOPINI WC



13

Cromato  
Chromed

G•ARGO

2333

Scopino WC con ciuffo in setole  
Toilet brush with bristle brush

ø 9 x 38 cm

Porte balai WC avec brosse en nylon  
WC-Bürstengarnitur mit Borsten-Aufsatz  
Escobillero con escobilla de nylon  
Туалетный ёршик с нейлоновой щетиной

Acciaio inox  
Stainless steel  
Acier inoxydable  
Edelstahl  
Acero inox  
Нержавеющая сталь

G•TESEO

4433

Scopino WC con ciuffo in setole  
Toilet brush with bristle brush

9 x 9 x 38 cm

13

Lucido  
Polished

Porte balai WC avec brosse en nylon  
WC-Bürstengarnitur mit Borsten-Aufsatz  
Escobillero con escobilla de nylon  
Туалетный ёршик с нейлоновой щетиной

Acciaio inox - Stainless steel  
Acier inoxydable  
Edelstahl - Acero inox  
Нержавеющая сталь











# G•YANNIS

## 2172

37 x 33,7 x 43,5 cm

Resine termoplastiche e acciaio  
 Thermoplastic resins and steel  
 Thermoplastique et acier  
 Kunststoff und Stahl  
 Resinas termoplásticas y acero  
 Термопластичные смолы и стали



TEST CONDOTTI DALL'ISTITUTO  
 DI CERTIFICAZIONE  
 QUALITÀ CABIATO (CO)  
 TESTED BY ISTITUTO  
 DI CERTIFICAZIONE  
 QUALITÀ CABIATO (CO)

Design: LucidiPevere

AS AWARDED BY THE CHICAGO  
 ATHENAEUM: MUSEUM  
 OF ARCHITECTURE  
 AND DESIGN



# SGABELLI

Stools - Tabourets - Hocker  
 Taburetes - Табуреты

02 Bianco  
 White

14 Nero  
 Black

3527

Appendiabiti

Hook

1,4 x 3 x 8,8 cm

Crochet - Haken  
Percha - Крючок

Cromall®



13

Cromato  
Chromed

2227

Appendiabiti

Hook

ø1,6 x 3 cm

Crochet - Haken  
Percha - КрючокOttone - Brass  
Laiton - Messing  
Latón - Латунь

Novità - New



13

Cromato  
Chromed

2229

Appendiabiti

Hook

ø1,6 x 5,5 cm

Crochet - Haken  
Percha - КрючокOttone - Brass  
Laiton - Messing  
Latón - Латунь

Novità - New



13

Cromato  
Chromed

## APPENDIABITI

Hooks - Crochets - Haken - Perchas - Крючки



2226

Appendiabiti doppio  
Double hook

8,3 x 3,3 x 4,6 cm

Crochet double - Haken doppelt  
Percha doble - Двойной крючок

Ottone - Brass  
Laiton - Messing  
Latón - Латунь

Novità - New



13 Cromato  
Chromed

2228

Appendiabiti multiplo  
Multiple hook

20,5 x 3,3 x 4,6 cm

Crochet quatre têtes  
Haken vierfach  
Percha cuádruple  
Мультикрючок

Ottone - Brass  
Laiton - Messing  
Latón - Латунь

Novità - New



13 Cromato  
Chromed





15,3 x 39,4 x 89,9 cm

7331

Piantana portasciugamani  
Towel stand

Porte serviette sur pied  
Handtuchständer  
Toallero de pie  
Стойка для полотенец

Cromato  
Chromed **13**

**Realizzate in acciaio inox,  
Cromall® e resine termoplastiche**  
Stainless steel,  
Cromall® and thermoplastic resins

Réalisés en acier inoxydable,  
Cromall® et thermoplastiquee  
Hergestellt aus Edelstahl,  
Cromall® und Kunststoff

Realizadas en acero inox,  
Cromall® y resinas termoplásticas  
Изготовлено из нержавеющей стали,  
Cromall® и термопластичных смол



15,3 x 34,3 x 64,4 cm

**NEW**

Nero matt  
Matt black **14**

7332

Colonnina portarotolo e scopino WC  
Bathroom butler consisting  
of toilet paper holder and toilet brush

Ensemble porte papier et balai de WC  
Ständer mit Papierrollenhalter und WC Bürstengarnitur  
Columna portarrollos y escobillero  
Стойка для ванной с туалетным ершиком и  
бумагодержателем





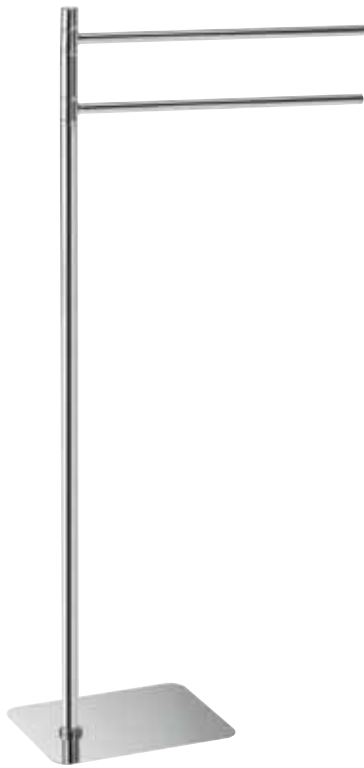

16,4 x 40 x 83,2 cm

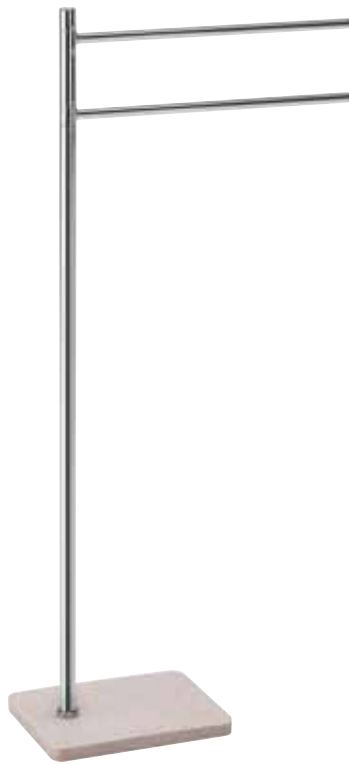

16,7 x 39,6 x 84 cm

1131

Piantana portasciugamani  
Towel stand

Porte serviette sur pied  
Handtuchständer  
Toallero de pie  
Стойка для полотенец

Beige  
Beige **03**

**Realizzate in acciaio inox,  
Cromall®, resina e sabbia**

Made of stainless steel,  
Cromall®, resin and sand  
Réalisés en acier inoxydable,  
Cromall®, résine et sable  
Hergestellt aus Edelstahl,  
Cromall®, Harz und Sand  
Realizadas en acero inox,  
Cromall®, resina y arena  
Изготовлено из нержавеющей стали,  
Cromall®, смол и песка



16,3 x 19 x 62,6 cm



16 x 17 x 65,5 cm

Cromato  
Chromed **13**

**Realizzate in acciaio inox, Cromall®**

Made of stainless steel, Cromall®  
Réalisés en acier inoxydable, Cromall®  
Hergestellt aus Edelstahl, Cromall®  
Realizadas en acero inox, Cromall®  
Изготовлено из нержавеющей стали, Cromall®

1132

Colonnina portarotolo e scopino WC  
Bathroom butler consisting  
of toilet paper holder and toilet brush

Ensemble porte papier et balai de WC  
Ständer mit Papierrollenhalter und WC Bürstengarnitur  
Columna portarrollos y escobillero  
Стойка для ванной с туалетным ершиком и  
бумагодержателем

# ACCESSORI ZONA DOCCIA

Shower and bathtub accessories

Accessoires pour douche et baignoire

Dusch-und Badewannenzubehör

Complementos de ducha y de bañera

Аксессуары для ванной и душа





## 5684

25 x 18,8 x 72,5 cm

Acciaio inox AISI 304  
 Stainless steel AISI 304  
 Acier inoxydable AISI 304  
 Edelstahl AISI 304  
 Acero inox AISI 304  
 Нержавеющая сталь AISI 304

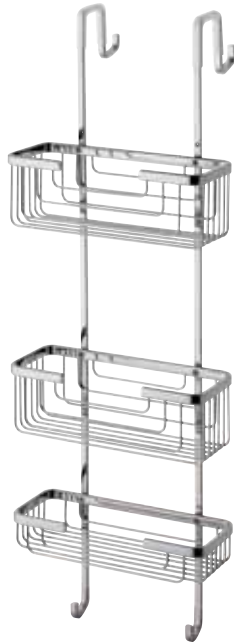

## 5681

17,3 x 17,3 x 34,5 cm

Ottone  
 Brass  
 Laiton  
 Messing  
 Latón  
 Латунь

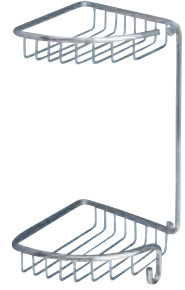

## 5683

24,5 x 18,5 x 55 cm

Acciaio inox AISI 304  
 Stainless steel AISI 304  
 Acier inoxydable AISI 304  
 Edelstahl AISI 304  
 Acero inox AISI 304  
 Нержавеющая сталь AISI 304



## 5620

42,5 x 13 x 11,5 cm

Ottone  
 Brass  
 Laiton  
 Messing  
 Latón  
 Латунь

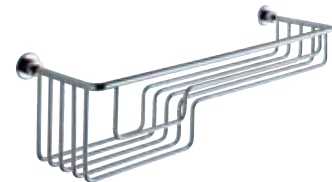

## 5685

18 x 26,5 x 55,5 cm

Acciaio inox AISI 304  
 Stainless steel AISI 304  
 Acier inoxydable AISI 304  
 Edelstahl AISI 304  
 Acero inox AISI 304  
 Нержавеющая сталь AISI 304

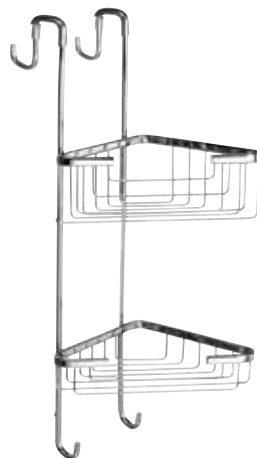

## 5618

33 x 13 x 7 cm

Ottone - Brass  
 Laiton - Messing  
 Latón - Латунь



## ANGOLARI E PORTA OGGETTI

Corner shelves - Étagères d'angle - Eckablagen - Estantes angulares - Угловая мыльница



2086

150 ml. - 5 x 10 x 17,1 cm

Ottone - Brass  
Laiton - Messing  
Latón - Латунь

## G•KYRON

13 Cromato

Chromed

Dosatore - Soap dispenser - Distributeur de savon - Seifenspender - Dosificadore de jabón - Дозаторы для жидкого мыла

100%  
made in Italy



ANTIBATTERICHE  
E ANTIMUFFA

ANTIBACTERIAL,  
ANTI-MOULD

antibacterienne, antimicrobique  
Antibakteriell und Schimmelhemmend  
antibacterianas, antimoho  
антибактериальные,  
антиплесень

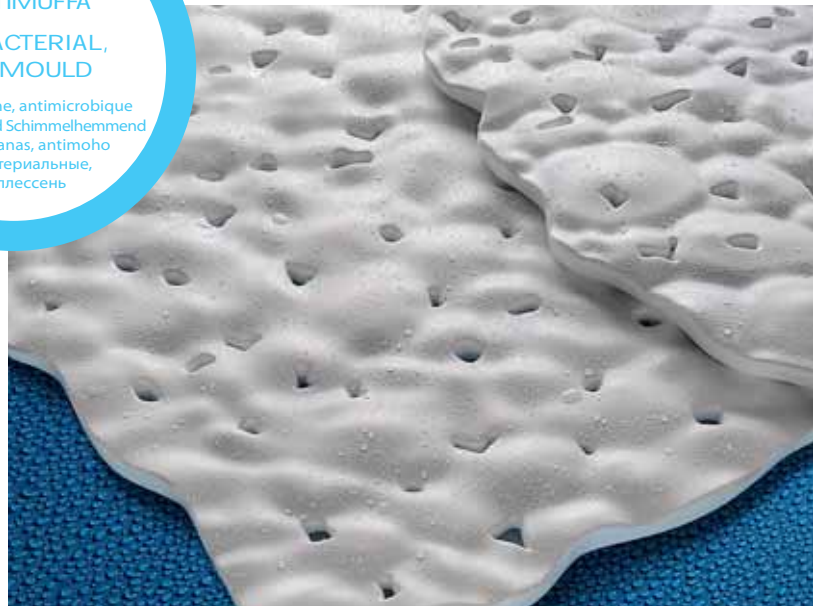

2683 55

55 x 2 x 55 cm

EVA

## G•BILBAO

02 Bianco

White

Pedane doccia - Shower mats - Caillebotis - Duschroste - Tarimas para ducha - Коврики для душа



# G•THOR

## 5641

13 Cromato  
Chromed

26 X 2,2 X 17,5 cm

Ottone  
Brass  
Laiton  
Messing  
Latón  
Латуни

Novità - New

## TERGIVETRO

Wiper-blade - Raclette de douche - Glasabzieher - Limpiacristales - Стеклоочиститель



# G•SIT-IN

## 4893

98 Iroko  
Iroko

120  
kg

48,9 x 33 x 10,5 cm

Sedile ribaltabile per doccia - Shower seat  
Siège pour douche repliable - Duschsitz hochklappbar  
Asiento abatible para ducha - Откидное сиденье для душа

100%  
made in Italy

Legno/alluminio/ABS  
Wood/aluminium/ABS  
Bois/aluminium/ABS  
Holz/Aluminium/ABS  
Madera/aluminio/ABS  
Дерево/алюминий/ABS

## SEDILI PER DOCCIA

Shower tub seats - Sièges pour douche - Duschklappsitz  
Asientos para ducha - Сидение в душ



GEDY

GEDY





## Indice GEDY

### □ WALL

2900	254	G•K2	244
G•BERNINA	214	G•KANSAS	202
G•COLORADO	218	G•KENT	190
G•DARIOS	252	G•MAINE	206
G•EDERA PLUS	224	G•MINDY	264
G•ETNA	240	G•NEW JERSEY	222
G•EVEREST	242	G•OLIMPO	234
G•FELCE	230	G•PIRENEI	198
G•FICUS	238	G•ROMANCE	210
G•GENZIANA	246	G•TEIDE	228
G•GLAMOUR	194	G•VERMONT	216
G•HOT	250	G•VESUVIO	262
G•JUNIOR	258		

### ■ TABLE TOP

ALTEA	266	GRAZIA	317
AMELIE	293	IDRA	314
ANTARES	322	ILARY	284
AQUARIUS	305	LIBRA	304
ARIES	302	LUCREZIA	277
ASTRID	282	LUCY	278
AZALEA	290	LUNA	329
BAMBU'	268	MARIKA	288
CATHERINE	292	MARINA	275
CHANELLE	320	MOBY	334
CHANTAL	287	MYOSOTIS	276
CLOTHILDE	294	NAOMI	285
DALIA	297	NEMESIA	269
DORI	316	NEW MARTINA	283
ELETTRA	271	NEW MIZAR	280
ERICA	267	NIGELLA	274
ETNICA	308	NIKITA	270
FLOU	328	NORA	300
GEMINI	306	OLIMPIA	315
GINEVRA	299	PETRA	309
GIULIA	326	PETUNIA	298
GLADY	330	PIXIS	336

POLARIS	272	SEVENTY	332
PRIMULA	273	SOFIA	301
QUADROTTO	310	SOLE	312
RAINBOW	324	TWIST	319
RITA	279	VEGA	327
SABINA	286	VERBENA	296
SELINA	318	VIVIENE	295

 **BEAUTY** - PAG. 337

 **HYGIENE** - PAG. 353

 **MULTIFUNCTION** - PAG. 375

 **WATER** - PAG. 409

 **SENSORIAL** - PAG. 475

La sequenza delle misure indicate per ogni articolo è la seguente: larghezza - profondità - altezza  
The succession of the sizes for each article is the following: width - thickness - height  
La séquence des mesures indiquées pour chaque article est la suivante: largeur - profondeur - hauteur  
Die Reihenfolge der Maße, die für jeden Artikel angezeigt werden, ist das folgende: Breite - Tiefe - Höhe  
La secuencia de las medidas indicadas para cada artículo es la siguiente: anchura - profundidad - altura  
Последовательность измерений показанных для каждой статьи: ширина - глубина - высота

Il design non è solo l'aspetto  
e la percezione.  
Il design è come funziona.

Design is not just  
what it looks like and feels like.  
Design is how it works.



WALL









## G•KENT



13  
Cromato  
Chromed

Realizzata in ottone e Cromall® con contenitori in vetro satinato

Made of brass and Cromall® with frosted glass containers

Réalisée en laiton et Cromall® avec boîtiers en verre satiné

Hergestellt aus Messing und Cromall® mit Behältern aus satiniertem Glas

Realizada en latón y Cromall® con contenedores en cristal satinado

Изготовлено из латуни и Cromall® с ёмкостями из матового стекла

5510

7,9 x 8,6 x 10,3 cm



5511

11,5 x 9,5 x 2,2 cm



5581

7,9 x 8,6 x 16 cm



5521/30

30,2 x 5,8 x 2,8 cm



5521/45

45 x 5,8 x 2,8 cm



5521/60

60,3 x 5,8 x 2,8 cm





13

Cromato  
Chromed



5523

36,5 x 1,5 x 7 cm



5522

35 x 5,5 x 5 cm



Novità - New

5570

23,2 x 5,4 x 14,6 cm



5524

15 x 7 x 2,8 cm



5533

9,7 x 9 x 36,2 cm



5525

15 x 10,7 x 7,7 cm



5427

2,8 x 5 x 3 cm





# G•GLAMOUR

Design Piet Billekens

13

Cromato  
Chromed



Realizzata in ottone e Cromall® con contenitori in vetro satinato

Made of brass and Cromall® with frosted glass containers

Réalisée en laiton et Cromall® avec boîtiers en verre satiné

Hergestellt aus Messing und Cromall® mit Behältern aus satiniertem Glas

Realizada en latón y Cromall® con contenedores en cristal satinado

Изготовлено из латуни и Cromall® с ёмкостями из матового стекла

5710

8 x 11 x 11 cm



5711

11,2 x 11,4 x 3,4 cm



5781

8 x 11 x 16 cm



5719/60

60 x 11,8 x 2,3 cm

3  
kg

Vetro temperato - tempered glass  
Verre tempéré - Sekuritglas  
Cristal templado - Закаленное стекло



5721/30

30 x 8,2 x 2 cm



5721/45

45 x 8,2 x 2 cm



5721/60

60 x 8,2 x 2 cm











13  
Cromato  
Chromed

5723 5770

3,2 x 33,5 x 4 cm

24 x 8,2 x 12,4 cm



5724 5726 5733/O3 5733

15,7 x 8,2 x 2 cm

4,2 x 3,7 x 2,6 cm

10 x 13 x 39 cm

10 x 10 x 39 cm



5728

3,2 x 7,7 x 4 cm





# G•PIRENEI

Realizzata in ottone e Cromall® con contenitori in vetro satinato

Made of brass and Cromall® with frosted glass containers

Réalisée en laiton et Cromall® avec boîtiers en verre satiné

Hergestellt aus Messing und Cromall® mit Behältern aus satiniertem Glas

Realizada en latón y Cromall® con contenedores en cristal satinado

Изготовлено из латуни и Cromall® с ёмкостями из матового стекла

13

Cromato  
Chromed

14

Nero matt  
Matt black

### PI10

6,9 x 9,1 x 10,4 cm



### PI11

11 x 11,2 x 4 cm



### PI81

6,9 x 9,1 x 15,4 cm



### PI21 / 35

35 x 6,6 x 2,5 cm



### PI21 / 45

45 x 6,6 x 2,5 cm



### PI21 / 60

60 x 6,6 x 2,5 cm





13

Cromato  
Chromed

14

Nero matt  
Matt black

PI23

35 x 6,6 x 2,5 cm



PI70

23 x 5 x 15 cm



PI24

17,5 x 6,6 x 2,5 cm



PI27

2 x 3,3 x 5,3 cm



PI33-03

8,5 x 10,9 x 36,5 cm







# G•KANSAS

Realizzata in acciaio inox e Cromall®  
con contenitori in vetro satinato o acciaio inox

Made of stainless steel and Cromall®  
with frosted glass containers or stainless steel

Réalisée en acier inoxydable et Cromall®  
avec boîtiers en verre satiné ou acier inoxydable

Hergestellt aus Edelstahl und Cromall®  
mit Behältern aus satiniertem Glas oder Edelstahl

Realizada en acero inox y Cromall®  
con contenedores en cristal satinado o acero inox

Изготовлено из нержавеющей стали и Cromall® с ёмкостями  
из матового стекла или нержавеющей стали

13

Cromato  
Chromed

3810

6,8 x 11,7 x 9,6 cm



3811

10,5 x 13,2 x 4 cm



3881

6,8 x 11,7 x 17 cm



38101310

6,9 x 6,9 x 12,4 cm



38111310

13,8 x 10,6 x 3 cm



38811310

6,9 x 6,9 x 17,3 cm



38101300

7 x 11,3 x 1,8 cm

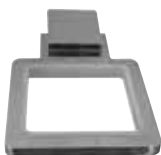

3819/60

60 x 11,7 x 1,6 cm

Vetro temperato - tempered glass  
Verre tempéré - Sekuritglas  
Cristal templado - Закаленное стекло

3  
kg



G•KANSAS

13

Cromato  
Chromed

3821/35

35 x 6,2 x 1,6 cm

3821/45

45 x 6,2 x 1,6 cm

3821/60

60 x 6,2 x 1,6 cm

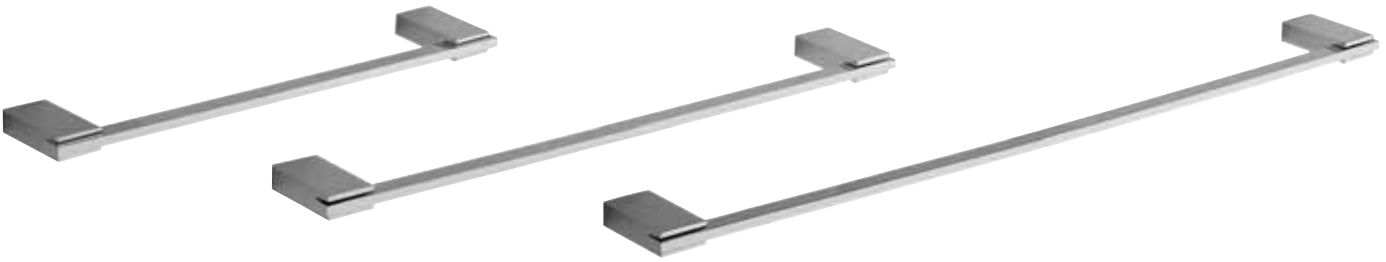

3823

30,4 x 6,2 x 3,8 cm

3822

35 x 6,3 x 3,1 cm

3833

8,7 x 8,7 x 36 cm

Acciaio cromato - Chromed steel  
 Acier chromé - Verchromter Stahl  
 Асери хромированная сталь



Novità - New

3870

20 x 6,2 x 12,7 cm

3824

14 x 6,2 x 9,7 cm

3826

8,2 x 5,5 x 1,8 cm





# G•MAINE

13

Cromato  
Chromed

Realizzata in acciaio inox e Cromall® con contenitori in vetro satinato  
 Made of stainless steel and Cromall® with frosted glass containers  
 Réalisée en acier inoxydable et Cromall® avec boîtiers en verre satiné  
 Hergestellt aus Edelstahl und Cromall® mit Behältern aus satiniertem Glas  
 Realizada en acero inox y Cromall® con contenedores en cristal satinado  
 Изготовлено из нержавеющей стали и Cromall® с ёмкостями из матового стекла



Fissabile anche con colla (venduta a parte)  
 Can be fixed with glue (sold separately)  
 Peut être fixé avec colle (vendu séparément)  
 Kann mit Kleber fixiert werden (separat erhältlich)  
 Se puede fijar con pegamento (se vende por separado)  
 Может быть закреплен клеем (продается отдельно)

TEST CONDOTTI  
 DALL'ISTITUTO  
 DI CERTIFICAZIONE  
 QUALITÀ CABIATE (CO)  
 TESTED BY ISTITUTO  
 DI CERTIFICAZIONE  
 QUALITÀ CABIATE (CO)

7810

6,8 x 9,7 x 12,4 cm



7811

14,6 x 10,6 x 6 cm



7881

6,9 x 11 x 16,8 cm



7819-60

58 x 11,6 x 6 cm



7821/35

38 x 6,5 x 6 cm









13

Cromato  
Chromed

3821/45

47,5 x 6,5 x 6 cm



3821/60

62,6 x 6,5 x 6 cm



7823

36 x 5,6 x 6 cm



7870

22,3 x 6,6 x 16,3 cm



7833

ø 8,4 x 36 cm

Acciaio cromato - Chromed steel  
 Acier chromé - Verchromter Stahl  
 Асоро хромодо - Хромированная сталь

7824

15 x 6,6 x 6 cm



7825

14,3 x 6,8 x 15 cm



7826

7,5 x 6,6 x 6 cm





# G•ROMANCE

44

Bronzo  
Bronzed



Realizzata in acciaio inox e Cromall® con contenitori in vetro satinato  
 Made of stainless steel and Cromall® with frosted glass containers  
 Réalisée en acier inoxydable et Cromall® avec boîtiers en verre satiné  
 Hergestellt aus Edelstahl und Cromall® mit Behältern aus satiniertem Glas  
 Realizada en acero inox y Cromall® con contenedores en cristal satinado  
 Изготовлено из нержавеющей стали и Cromall® с ёмкостями из матового стекла

Fissabile anche con colla (venduta a parte)  
 Can be fixed with glue (sold separately)  
 Peut être fixé avec colle (vendu séparément)  
 Kann mit Kleber fixiert werden (separat erhältlich)  
 Se puede fijar con pegamento (se vende por separado)  
 Может быть закреплен клеем (продается отдельно)

<b>7510</b>	<b>7511</b>	<b>7581</b>
7,4 x 11,4 x 11,5 cm	14,6 x 11,6 x 5,6 cm	7,2 x 12,3 x 17,4 cm



<b>7519 / 60</b>	<b>7521 / 35</b>
60 x 11 x 5,6 cm	34,8 x 7,7 x 5,6 cm



Vetro temperato - tempered glass  
 Verre tempéré - Sekuritglas  
 Cristal templado - Закаленный стекло

fissaggio con viti - fixed with screws



<b>7521 / 45</b>	<b>7521 / 60</b>
44,8 x 7,7 x 5,6 cm	59,8 x 7,7 x 5,6 cm



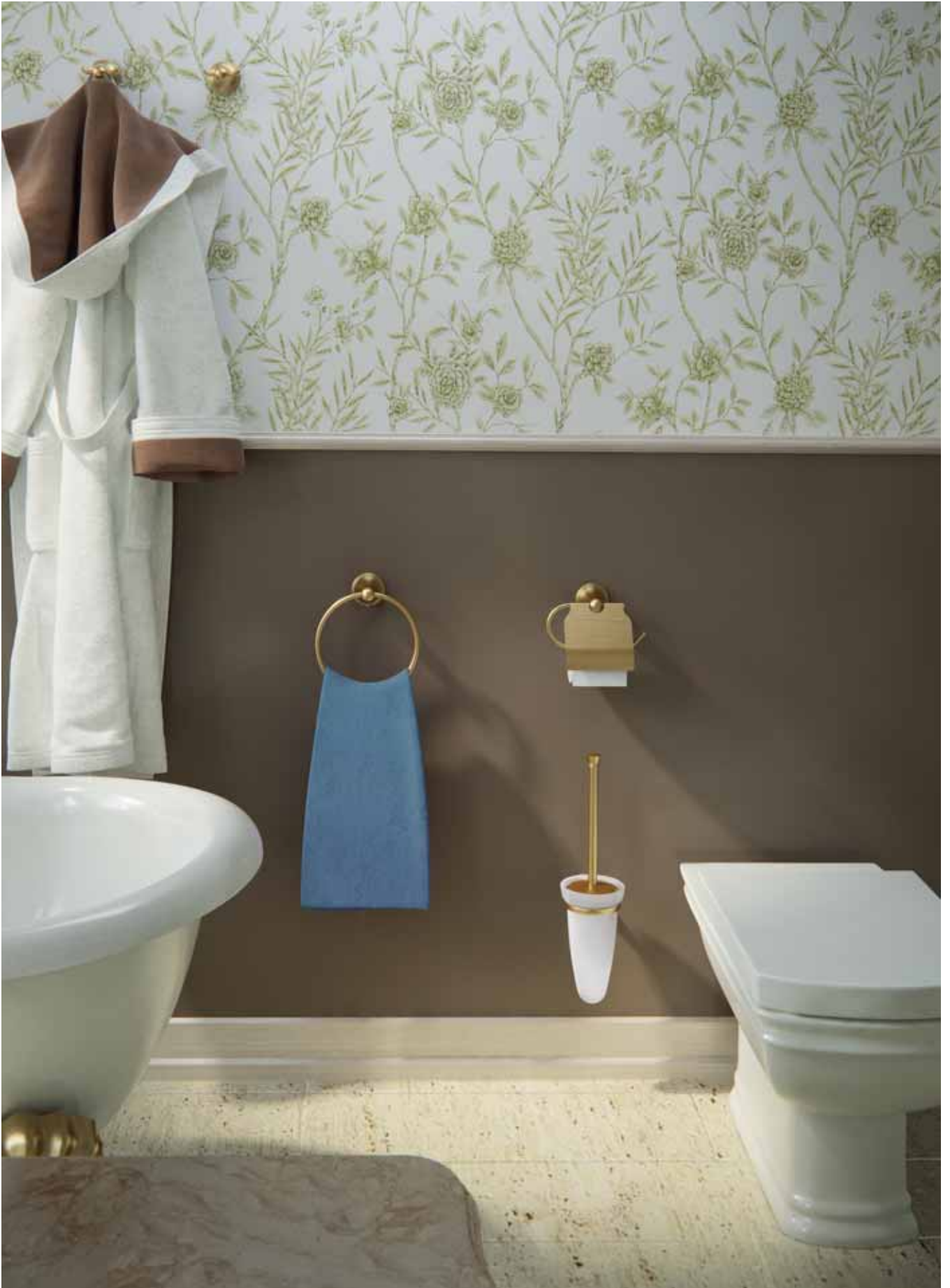

44

Bronzo  
Bronzed

7523

36,3 x 7,7 x 7,4 cm  
fissaggio con viti - fixed with screws



7570

18 x 7,7 x 20,2 cm



7524

17,8 x 7,7 x 5,6 cm



7525

16,4 x 7,7 x 13,7 cm



7526

8,2 x 7,7 x 5,6 cm



7533/O3

10,9 x 14,5 x 41,8 cm



7533

ø 9 x 41 cm











# G•BERNINA

13  
Cromato  
Chromed



Serie in acciaio inox e Cromall® con contenitori in vetro satinato  
 Made of stainless steel and Cromall® with frosted glass containers  
 Série en acier inoxydable et Cromall® avec boîtiers en verre satiné  
 Serie aus Edelstahl und Cromall® mit Behältern aus satiniertem Glas  
 Serie en acero inoxidable y Cromall® con contenedores en cristal satinado  
 Изготовлено из нержавеющей стали и Cromall® с ёмкостями из матового стекла







Fissabile anche con colla (venduta a parte)  
 Can be fixed with glue (sold separately)  
 Peut être fixé avec colle (vendu séparément)  
 Kann mit Kleber fixiert werden (separat erhältlich)  
 Se puede fijar con pegamento (se vende por separado)  
 Может быть закреплен клеем (продается отдельно)

BE10

ø 6,9 x 10,1 x 10,5 cm



BE11

10,8 x 12 x 4 cm



BE81

ø 6,9 x 11,5 x 15,3 cm



BE21 / 35

35 x 5,5 x 3,5 cm



BE21 / 45

45 x 5,5 x 3,5 cm



BE21 / 60

60 x 5,5 x 3,5 cm



BE70

23 x 6,6 x 15 cm



BE24

18,2 x 6,6 x 3,5 cm



BE25

18,3 x 7,3 x 13 cm



BE26

8,5 x 5,6 x 4 cm





# G•VERMONT

13  
Cromato  
Chromed



Realizzata in acciaio inox e Cromall® con contenitori in vetro satinato  
 Made of stainless steel and Cromall® with frosted glass containers  
 Réalisée en acier inoxydable et Cromall® avec boîtiers en verre satiné  
 Hergestellt aus Edelstahl und Cromall® mit Behältern aus satiniertem Glas  
 Realizada en acero inox y Cromall® con contenedores en cristal satinado  
 Изготовлено из нержавеющей стали и Cromall® с ёмкостями из матового стекла



Fissabile anche con colla (venduta a parte)  
 Can be fixed with glue (sold separately)  
 Peut être fixé avec colle (vendu séparément)  
 Kann mit Kleber fixiert werden (separat erhältlich)  
 Se puede fijar con pegamento (se vende por separado)  
 Может быть закреплен клеем (продается отдельно)

4210

6,5 x 11 x 9,5 cm



4211

11 x 13 x 6 cm



4226

7,5 x 5 x 6 cm



4221/35

35,4 x 8,2 x 6 cm



4221/45

45,5 x 8 x 6 cm



4221/60

60,5 x 9,1 x 6 cm



4223

35 x 7 x 6 cm



4270

22,5 x 6 x 16 cm



4233

ø 9,1 x 37,3 cm



4224

18,3 x 8,4 x 6 cm



4225

17 x 6 x 14,5 cm





# G•COLORADO

13  
Cromato  
Chromed



Realizzata in acciaio inox e Cromall®  
con contenitori in vetro satinato o acciaio inox  
Made of stainless steel and Cromall®  
with frosted glass containers or stainless steel  
Réalisée en acier inoxydable et Cromall®  
avec boîtiers en verre satiné ou acier inoxydable  
Hergestellt aus Edelstahl und Cromall®  
mit Behältern aus satiniertem Glas oder Edelstahl  
Realizada en acero inox y Cromall®  
con contenedores en cristal satinado o acero inox  
Изготовлено из нержавеющей стали и Cromall®  
с ёмкостями из матового стекла

Fissabile anche con colla (venduta a parte)  
Can be fixed with glue (sold separately)  
Peut être fixé avec colle (vendu séparément)  
Kann mit Kleber fixiert werden (separat erhältlich)  
Se puede fijar con pegamento (se vende por separado)  
Может быть закреплен клеем (продается отдельно)

6910

7 x 10,5 x 10,5 cm



6911

10 x 12,5 x 5 cm



6981

7 x 10,5 x 15,5 cm



38101310

6,9 x 6,9 x 12,4 cm



38111310

13,8 x 10,6 x 3 cm



38811310

6,9 x 6,9 x 17,3 cm



69101300

7 x 11,3 x 1,8 cm



6919/60

57 x 11,5 x 4 cm

Vetro temperato - tempered glass  
Verre tempéré - Sekuritglas  
Cristal templado - Закаленное стекло

fissaggio con viti - fixed with screws

6,5 kg









G•COLORADO

13

Cromato  
Chromed

6921/35

35 x 8 x 4 cm

6921/45

45 x 8 x 4 cm

6921/60

60 x 8 x 4 cm



6923

4 x 36 x 5,5 cm

6970

20 x 6,5 x 14,5 cm

6924

17 x 8 x 4 cm

6933

8,7 x 8,7 x 36 cm



Acciaio inox - Stainless steel  
 Acier inoxydable - Edelstahl  
 Acero inox - Нержавеющая сталь



6925

14,3 x 6,5 x 12 cm

6926

4 x 5 x 4 cm

6928

6,5 x 6 x 4 cm





# G•NEW JERSEY

13  
Cromato  
Chromed



Realizzata in acciaio inox, Cromall® e resine termoplastiche e vetro satinato  
 Made of stainless steel, Cromall® and thermoplastic resins and frosted glass  
 Réalisée en acier inoxydable, Cromall® et thermoplastique et verre satiné  
 Hergestellt aus Edelstahl, Cromall® und Kunststoff und satiniertem Glas  
 Realizada en acero inox, Cromall® y resinas termoplásticas y cristal satinado  
 Изготовлено из нержавеющей стали, Cromall® и термопластичных смол и матового стекла

7 kg

Fissabile anche con colla (venduta a parte)  
 Can be fixed with glue (sold separately)  
 Peut être fixé avec colle (vendu séparément)  
 Kann mit Kleber fixiert werden (separat erhältlich)  
 Se puede fijar con pegamento (se vende por separado)  
 Может быть закреплен клеем (продается отдельно)

2810

6,7 x 9,8 x 9,6 cm



2811

10,9 x 11,9 x 5 cm



2881

6,8 x 11 x 15,5 cm



2826

7 x 6,7 x 4,2 cm



2821/35

37,6 x 6,7 x 4,2 cm



2821/45

47,6 x 6,7 x 4,2 cm



2821/60

62,6 x 6,7 x 4,2 cm



2870

20,5 x 6,7 x 12 cm



2824

17 x 6,7 x 4,2 cm



2825

14,5 x 7,2 x 11 cm



2833

9 x 9 x 38 cm

Acciaio inox - Stainless steel  
 Acier inoxydable  
 Edelstahl - Acero inox  
 Нержавеющая сталь





# G•EDERA PLUS

Realizzata in acciaio inox e Cromall® con contenitori in vetro satinato

Made of stainless steel and Cromall® with frosted glass containers

Réalisée en acier inoxydable et Cromall® avec boîtiers en verre satiné

Hergestellt aus Edelstahl und Cromall® mit Behältern aus satiniertem Glas

Realizada en acero inox y Cromall® con contenedores en cristal satinado

Изготовлено из нержавеющей стали и Cromall®

с ёмкостями из матового стекла

13

Cromato  
Chromed







Fissabile anche con colla (venduta a parte)  
Can be fixed with glue (sold separately)  
Peut être fixé avec colle (vendu séparément)  
Kann mit Kleber fixiert werden (separat erhältlich)  
Se puede fijar con pegamento (se vende por separado)  
Может быть закреплен клеем (продается отдельно)

EP10

11,2 x 9,8 x 9,9 cm



EP11

13,7 x 11,9 x 5,7 cm



EP81

11,3 x 11,2 x 15,7 cm



EP12

13 x 11,4 x 5,4 cm

Inamovibile - Fixed



EP19/55

53 x 14,1 x 5,4 cm

Vetro temperato - tempered glass  
Verre tempéré - Sekuritglas  
Cristal templado - Закаленное стекло

fissaggio con viti - fixed with screws

5  
kg



EP21/35

38,3 x 7,4 x 5,4 cm



EP21/45

48,3 x 7,4 x 5,4 cm



EP21/60

63,3 x 7,4 x 5,4 cm







13

Cromato  
Chromed

EP23

36 x 4,6 x 5,4 cm



EP70

20 x 7,4 x 15,7 cm



EP24

14,5 x 7,4 x 5,4 cm



EP24 /O2

8,8 x 10,9 x 17,2 cm



EP25

14,6 x 7,4 x 14,1 cm



EP26

7,6 x 7,4 x 5,4 cm



ED34

ø 7,5 x 40 cm

Acciaio inox - Stainless steel Acier  
inoxydable - Edelstahl - Acero inox  
Нержавеющая сталь

ED34 /O3

7,5 x 8 x 40 cm

Acciaio inox - Stainless steel Acier  
inoxydable - Edelstahl - Acero inox  
Нержавеющая сталь



Novità - New

13

Cromato  
Chromed

## G•TEIDE

Realizzata in acciaio inox, Cromall® con contenitori in vetro satinato

Made of stainless steel, Cromall® with frosted glass containers

Réalisée en acier inoxydable, Cromall® avec boîtiers en verre satiné

Hergestellt aus Edelstahl, Cromall® mit Behältern aus satiniertem Glas

Realizada en acero inox, Cromall® con contenedores en cristal satinado

Изготовлено из нержавеющей стали, Cromall® с ёмкостями из матового стекла

Fissaggio con biadesivo o viti  
To be fixed with double-sided  
sticky tape or screwsFixation avec adhésif double face ou vis - Befestigung mit  
doppelseitigem - Klebeband oder Schrauben  
Fijación con adhesivo de dos caras o tornillos - Крепление  
при помощи двухсторонней клейкой ленты или шурупов

TE10

6,7 x 9,1 x 9,6 cm



TE11

11 x 11,5 x 5,2 cm



TE55

10 x 14 x 7,3 cm



TE21 / 30

30 x 6,7 x 5,3 cm



TE21 / 45

45,5 x 6,7 x 5,3 cm



TE21 / 60

60 x 6,7 x 5,3 cm



TE26

6,5 x 4,1 x 5,3 cm



TE24

13,2 x 4,5 x 10 cm



TE70

20 x 7,2 x 10 cm





# G•FELCE

13

Cromato  
Chromed

Realizzata in acciaio inox e Cromall® con contenitori in vetro satinato  
 Made of stainless steel and Cromall® with frosted glass containers  
 Réalisée en acier inoxydable et Cromall® avec boîtiers en verre satiné  
 Hergestellt aus Edelstahl und Cromall® mit Behältern aus satiniertem Glas  
 Realizada en acero inox y Cromall® con contenedores en cristal satinado  
 Изготовлено из нержавеющей стали и Cromall® с ёмкостями из матового стекла

FISSAGGIO AD INCOLLO • FIXES INTO PLACE WITH GLUE



10 kg

FISSAGGIO CON VITI • FIXES WITH SCREWS



Fissabile anche con colla (venduta a parte)  
 Can be fixed with glue (sold separately)  
 Peut être fixé avec colle (vendu séparément)  
 Kann mit Kleber fixiert werden (separat erhältlich)  
 Se puede fijar con pegamento (se vende por separado)  
 Может быть закреплен клеем (продается отдельно)

FE10

6,7 x 10,2 x 10 cm



FE11

11 x 12,3 x 5,6 cm



FE81

6,8 x 10,3 x 15,4 cm



FE19/55

52 x 13,1 x 5,6 cm

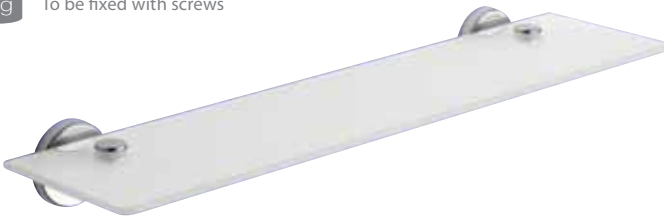
 Fissaggio con viti  
 To be fixed with screws

FE21/35

39,6 x 7,4 x 5,6 cm



FE21/45

52 x 7,4 x 5,6 cm

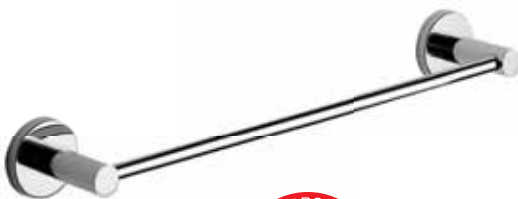

FE21/60

64,6 x 7,4 x 5,6 cm









13

Cromato  
Chromed

## FE23

36,9 x 4,8 x 5,6 cm

Fissaggio con viti - To be fixed with screws



## FE70

19,3 x 5,5 x 15,2 cm



## FE24

5,6 x 12,6 x 5,6 cm



## FE29

15,5 x 7,8 x 5,6 cm



## FE25

13,5 x 5,5 x 14,5 cm



## FE33

ø 7,8 x 33,4 cm

Acciaio inox - Stainless steel  
Acier inoxydable - Edelstahl  
Асeрo inox - Нeржaвeющeй стaли

## FE26

6,5 x 5,5 x 5,6 cm









Novità - New

13

Cromato  
Chromed

G•OLIMPO

O124

15,2 x 6,8 x 4,5 cm



O125

12,6 x 4,8 x 13 cm



O170

15,6 x 4,8 x 17,3 cm



O126

6,5 x 4,8 x 4,5 cm









# G•FICUS

Realizzata in metallo e Cromall® con contenitori in vetro satinato  
 Made of metal and Cromall® with frosted glass containers  
 Réalisée en métal et Cromall® avec boîtiers en verre satiné  
 Hergestellt aus Metall und Cromall® mit Behältern aus satiniertem Glas  
 Realizada en metal y Cromall® con contenedores en cristal satinado  
 Изготовлено из металла и Cromall® с ёмкостями из матового стекла

13

Cromato  
Chromed

FI10

6,7 x 10 x 9,5 cm



FI11

11 x 12,5 x 5 cm



FI81

6,5 x 10,5 x 15 cm



FI26

6,5 x 5 x 5 cm



FI19/55

52 x 13 x 5 cm

7,5  
kgVetro temperato - tempered glass  
Verre tempéré - Sekuritglas  
Cristal templado - Закаленное стекло

FI21/35

38,5 x 7 x 5 cm



FI21/60

64,5 x 7 x 5 cm



FI23

36,9 x 4,8 x 5,6 cm



FI33

ø 7,5 x 33 cm



FI70

15,6 x 4,7 x 18,2 cm



FI24

15,5 x 7 x 5 cm



FI25

12,6 x 5,5 x 14 cm





# G•ETNA

Realizzata in acciaio e Cromall® con contenitori in vetro satinato  
 Made of steel and Cromall® with frosted glass containers  
 Réalisée en acier et Cromall® avec boîtiers en verre satiné  
 Hergestellt aus Stahl und Cromall® mit Behältern aus satiniertem Glas  
 Realizada en acero y Cromall® con contenedores en cristal satinado  
 Изготовлено из стали и Cromall® с ёмкостями из матового стекла

13

Cromato  
Chromed

## EN10

11,7 x 8,7 x 10,3 cm



## EN12

11,7 x 8,7 x 4,6 cm

Inamovibile - Fixed



## EN26

5,6 x 4,1 x 4,7 cm



## EN21 / 35

34,7 x 8,3 x 4,8 cm



## EN21 / 45

44,7 x 8,3 x 4,8 cm



## EN21 / 60

59,7 x 8,3 x 4,8 cm



## EN70

15,7 x 4,5 x 17,6 cm



## EN24

16,5 x 8,3 x 4,8 cm





# G•EVEREST

Realizzata in acciaio e Cromall® con contenitori in vetro satinato  
 Made of steel and Cromall® with frosted glass containers  
 Réalisée en acier et Cromall® avec boîtiers en verre satiné  
 Hergestellt aus Stahl und Cromall® mit Behältern aus satiniertem Glas  
 Realizada en acero y Cromall® con contenedores en cristal satinado  
 Изготовлено из стали и Cromall® с ёмкостями из матового стекла

13

Cromato  
Chromed

Fissabile anche con colla (venduta a parte)  
 Can be fixed with glue (sold separately)  
 Peut être fixé avec colle (vendu séparément)  
 Kann mit Kleber fixiert werden (separat erhältlich)  
 Se puede fijar con pegamento (se vende por separado)  
 Может быть закреплен клеем (продается отдельно)

<b>EV10</b> 6,8 x 11,6 x 9,4 cm 	<b>EV11</b> 10,7 x 13,6 x 7 cm 	<b>EV12</b> 10,7 x 10,3 x 7 cm Inamovibile - Fixed 	<b>EV80</b> 6,8 x 11,7 x 15 cm 
--	---------------------------------------	--	---------------------------------------

<b>EV21/35</b> 35 x 7 x 7 cm 	<b>EV21/45</b> 45 x 7 x 7 cm 	<b>EV21/60</b> 60 x 7 x 7 cm 
-------------------------------------	-------------------------------------	-------------------------------------

ACCORCIABILE 10/35 SHORTENABLE  
 ACCORCIABILE 10/45 SHORTENABLE  
 ACCORCIABILE 10/60 SHORTENABLE

<b>EV23</b> 38 x 3,1 x 7 cm 	<b>EV70</b> 16 x 3,1 x 19 cm 	<b>EV33/O3</b> 11,7 x 13,9 x 33,5 cm 
------------------------------------	-------------------------------------	---

<b>EV24</b> 15,9 x 7,3 x 7 cm 	<b>EV25</b> 12,8 x 9,2 x 10,9 cm 	<b>EV26</b> 6,8 x 5,3 x 7 cm 	
--------------------------------------	---	-------------------------------------	--







## G•K2

Novità - New

13

Cromato  
Chromed

Realizzata in Cromall® con contenitori in vetro satinato  
 Made of Cromall® with frosted glass containers  
 Réalisée en Cromall® avec boîtiers en verre satiné  
 Hergestellt aus Cromall® mit Behältern aus satiniertem Glas  
 Realizada en Cromall® con contenedores en cristal satinado  
 Изготовлено из Cromall® с ёмкостями из матового стекла



Fissabile anche con colla (venduta a parte)  
 Can be fixed with glue (sold separately)  
 Peut être fixé avec colle (vendu séparément)  
 Kann mit Kleber fixiert werden (separat erhältlich)  
 Se puede fijar con pegamento (se vende por separado)  
 Может быть закреплен клеем (продается отдельно)

KD10

11,7 x 8,7 x 10,3 cm



KD12

11,7 x 8,7 x 4,6 cm

Inamovibile - Fixed



KD21/45

44,7 x 8,3 x 4,8 cm



KD21/60

59,7 x 8,3 x 4,8 cm



KD70

15,7 x 4,5 x 17,6 cm



KD24

16,5 x 8,3 x 4,8 cm



KD26

5,6 x 4,1 x 4,7 cm





# G•GENZIANA

Realizzata in acciaio e Cromall® con contenitori in vetro satinato  
 Made of steel and Cromall® with frosted glass containers  
 Réalisée en acier et Cromall® avec boîtiers en verre satiné  
 Hergestellt aus Stahl und Cromall® mit Behältern aus satiniertem Glas  
 Realizada en acero y Cromall® con contenedores en cristal satinado  
 Изготовлено из стали и Cromall® с ёмкостями из матового стекла

13

Cromato  
Chromed

02

Bianco  
White

GE10

6,7 x 11 x 9,5 cm



GE11

10,8 x 13 x 3,8 cm



GE80

7,5 x 11,5 x 17 cm



13

Disponibile  
solo in cromato  
Available only  
in chromed

GE19/55

52 x 13 x 6 cm

8,5  
kgVetro temperato - tempered glass  
Verre tempéré - Sekuritglas  
Cristal templado - Закаленное стекло

13

Disponibile  
solo in cromato  
Available only  
in chromed

GE21/35

39,2 x 5,5 x 3,8 cm



GE21/45

45 x 5,5 x 3,8 cm



GE21/60

57,5 x 5,5 x 3,8 cm





13

Cromato  
Chromed

02

Bianco  
White

GE70

16 x 5,7 x 17 cm



GE26

6,5 x 5,5 x 3,8 cm



GE24

16,6 x 6,5 x 3,8 cm



GE33

ø 7,5 x 33 cm







# G•HOT

Realizzata in metallo e resine termoplastiche  
 Made of metal and thermoplastic resins  
 Réalisée en métal and thermoplastique  
 Hergestellt aus Metall und Kunststoff  
 Realizada en metal y resinas termoplásticas  
 Изготовлено из металла и термопластичных смол

13

Cromato  
Chromed



Solo su superfici lisce (specchi, piastrelle)  
 For flat surfaces (mirrors, tiles) only

Fissaggio con ventosa - Suction cup fixing  
 Fixation avec ventouses - Befestigung mit Saugnäpfen  
 Fijación con ventosas - Крепление при помощи присосок



## HO20

27,5 x 13,6 x 12 cm

10 kg



## HO80

19 x 19 x 10 cm

10 kg



## HO21/30

28,2 x 5,5 x 15,3 cm



## HO70

16 x 4 x 22 cm



## HO24

16 x 6 x 15,5 cm



## HO26

6,3 x 4,5 x 10,8 cm



## HO08

15 x 27 max x 22 cm



## HO52

10,7 x 12 x 22 cm





02

Bianco  
White100%  
made in Italy

# G•DARIOS

Realizzata in resine termoindurenti  
 Made of thermosetting resins  
 Réalisée en thermodurcissable  
 Hergestellt aus Duroplast  
 Realizada en resinas termoestables  
 Изготовлено из термореактивных смол

7210

18 x 11,5 x 10 cm



7211

18 x 11,5 x 3,5 cm



7218

32 x 11,5 x 3,5 cm



7221/30

32 x 11,5 x 3,5 cm



7221/60

60 x 11,5 x 3,5 cm



7219/60

60 x 11,5 x 3,5 cm

6,5  
kg

7224

18 x 11,5 x 3,5 cm



7225

14 x 15 x 12 cm

resine termoplastiche - thermoplastic resins  
 thermoplastique - Kunststoff - resinas  
 termoplásticas - Термопластичные смолы



7226

15 x 6 x 5 cm



8034

ø 12,5 x 37,5 cm

resine termoplastiche  
 thermoplastic resins  
 thermoplastique  
 Kunststoff  
 resinas termoplásticas  
 Термопластичные смолы

Design:  
 Gianpietro  
 Tonetti





02

Bianco  
White100%  
made in Italy  

## G•2900

Design Makio Hasuike

Realizzata in resine termoplastiche  
 Made of thermoplastic resins  
 Réalisée en thermoplastique  
 Hergestellt aus Kunststoff  
 Realizada en resinas termoplásticas  
 Изготовлено из термопластичных смол

2910

15 x 12,5 x 8,5 cm



2911

15 x 12,5 x 4,5 cm



2919/45

44,5 x 12 x 2,6 cm

6,5  
kg

2919/60

66 x 14 x 4,6 cm

5,5  
kg

2921/30

30 x 7 x 4,6 cm



2921/60

60 x 7 x 4,6 cm



2970

24,5 x 7 x 13 cm









G•2900

Design Makio Hasuike

02

Bianco  
White100%  
made in Italy  

2924

17 x 12,5 x 5,7 cm



2925

14,5 x 13 x 12 cm



6027

4,9 x 4,2 x 10,5 cm



5027

4,5 x 4,5 x 8 cm



2033

ø 15 x 33,5 cm

GEDY  
ICON  
ITEM45<sup>TH</sup>  
ANNIVERSARY**MoMA** June 27, 1977  
In permanent Design Collection  
of the Museum of Modern Art  
in New York

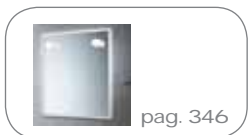

# G•JUNIOR

Design Gianpietro Tonetti

Realizzata in resine termoplastiche

Made of thermoplastic resins - Réalisée en thermoplastique  
Hergestellt aus Kunststoff - Realizada en resinas termoplásticas

Изготовлено из термопластичных смол

02

Bianco  
White

100%  
made in Italy



\* Fissaggio con biadesivo o viti

To be fixed with double-sided adhesive tape or screws

Fixation avec adhésif double face ou vis - Befestigung mit doppelseitigem - Klebeband oder Schrauben

Fijación con adhesivo de dos caras o tornillos - Крепление при помощи двухсторонней клейкой ленты или шурупов



\*\* Fissaggio con ventose o viti

To be fixed with suction cups or screws

Fixation avec ventouses ou vis - Befestigung mit Saugnapfen oder Schrauben

Fijación con ventosas o tornillos - Крепление при помощи присосок или шурупов

8010\*\*

15 x 12 x 6,5 cm



8011\*\*

15 x 12 x 4 cm



8012\*\*

30 x 12 x 4 cm



8019/60\*\*

60 x 12 x 4 cm



8080\*\*

19,6 x 15,6 x 3 cm

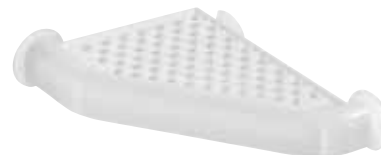

8021/30\*\*

30 x 10 x 4 cm



8021/55\*\*

55 x 10 x 4 cm





# G•JUNIOR

Design Gianpietro Tonetti

02

Bianco  
White

100%  
made in Italy



8023 \*

40 x 3,2 x 15,7 cm



8024 \*\*

15 x 10,6 x 4 cm



8026 \*

2,8 x 2,6 x 6 cm



8028 \*\*

19,9 x 6,5 x 3 cm



8033

ø 13,5 x 39 cm



8034

ø 12,5 x 37,5 cm







# G•VESUVIO

Realizzata in resine termoplastiche  
 Made of thermoplastic resins  
 Réalisée en thermoplastique  
 Hergestellt aus Kunststoff  
 Realizada en resinas termoplásticas  
 Изготовлено из термопластичных смол

02

Bianco  
 White



Solo su superfici lisce (specchi, piastrelle)  
 For flat surfaces (mirrors, tiles) only

Fissaggio con ventosa - Suction cup fixing  
 Fixation avec ventouses - Befestigung mit Saugnäpfen  
 Fijación con ventosas - Крепление при помощи присосок

**VS11**

11,3 x 7,8 x 11 cm

**VS21 30**

30-53 x 3 x 9,5 cm

**VS70**

18 x 3 x 16 cm

**VS28**

5,5 x 3 x 11 cm

**VS26**

11,3 x 3 x 11 cm

**VS24**

17 x 3 x 15 cm

**VS25**

15 x 3 x 17 cm



# G•MINDY

Design: R. & S. Prodotto Gedy

02

Bianco  
White

Realizzata in resine termoplastiche  
Made of thermoplastic resins  
Réalisée en thermoplastique  
Hergestellt aus Kunststoff  
Realizada en resinas termoplásticas  
Изготовлено из термопластичных смол



Possibile fissaggio con biadesivo (venduto a parte)  
Can be fixed with double-sided (sold separately)  
Peut être fixé avec adhésif double (vendu séparément)  
Kann mit Klebstoff fixiert (separat erhältlich)  
Se puede fijar con adhesivo de dos caras (se vende por separado)  
Может быть при помощи двухсторонней  
клеякой ленты (продается отдельно)

8410

13,3 x 9 x 10,4 cm



8411

13,3 x 9 x 3,5 cm



8421 / 30

33,4 x 9 x 3,5 cm



8421 / 50

53,4 x 9 x 3,5 cm



8424

16 x 9 x 3,5 cm



8426

9,3 x 5,6 x 4,1 cm



# TABLE TOP



# G•ALTEA

Realizzata in bambù  
 Made of bamboo  
 Réalisée en bambou  
 Hergestellt aus Bambus  
 Realizada en bambú  
 Изготовлено из бамбука

35

Naturale  
 Natural



AL98

ø 7 x 12 cm



AL11

ø 11,7 x 2 cm



AL80

ø 7 x 17,2 cm



AL33

ø 8,5 x 47,5 cm



# G•ERICA

Realizzata in legno e acciaio  
 Made of wood and steel  
 Réalisée en bois et acier  
 Hergestellt aus Holz und Stahl  
 Realizada en madera y acero  
 Изготовлено из дерева и стали

30

Noce  
 Walnut  
 colour



ER98

ø 7,1 x 11 cm



ER11

ø 11,5 x 1,9 cm



ER81

ø 7,2 x 16,4 cm



ER33

ø 8,9 x 36 cm





# G•BAMBÙ

Realizzata in bambù  
 Made of bamboo  
 Réalisée en bambou  
 Hergestellt aus Bambus  
 Realizada en bambú  
 Изготовлено из бамбука

35

Naturale  
 Natural



BA98

7,4 x 7,4 x 11 cm



BA11

13,4 x 9,6 x 2,5 cm



BA81

7,4 x 7,4 x 16,8 cm



BA33

10 x 10 x 36,5 cm





# G•NEMESIA

Realizzata in acciaio inox  
 Made of stainless steel  
 Réalisée en acier inoxydable  
 Hergestellt aus Edelstahl  
 Realizada en acero inox  
 Изготовлено из нержавеющей стали

13

Cromato  
 Chromed



NE98

6 x 6 x 10 cm



NE11

11,8 x 11,8 x 2 cm



NE81

6 x 6 x 18 cm



NE33

9 x 9 x 38 cm



NE33 O3

9 x 9,5 x 38 cm



# G•NIKITA

Realizzata in acciaio inox

Made of stainless steel

Réalisée en acier inoxydable

Hergestellt aus Edelstahl

Realizada en acero inox

Изготовлено из нержавеющей стали

38

Finitura  
spazzolata  
Brushed  
finishing

85

Antracite  
Anthracite



NK98

7 x 7 x 11 cm



NK11

13 x 10 x 2,5 cm



NK80

7 x 10 x 14 cm



NK33

10,5 x 10,5 x 43,5 cm



# G•ELETTRA

Realizzata in acciaio inox  
 Made of stainless steel  
 Réalisée en acier inoxydable  
 Hergestellt aus Edelstahl  
 Realizada en acero inox

15  
 Rame  
 Copper

Изготовлено из нержавеющей стали



EE98

ø 6,3 x 11,3 cm



EE11

11 x 8 x 2 cm



EE80

ø 6,3 x 19 cm



EE33

ø 8 x 46,8 cm



# G•POLARIS

Realizzata in acciaio inox  
 Made of stainless steel  
 Réalisée en acier inoxydable  
 Hergestellt aus Edelstahl  
 Realizada en acero inox  
 Изготовлено из нержавеющей стали

13

Cromato  
 Chromed



PL98

10,2 x 4,5 x 10 cm



PL11

12,6 x 10,2 x 2,5 cm



PL80

10,2 x 4,5 x 15,3 cm



PL33

12,5 x 9,5 x 39,4 cm



# G•PRIMULA

Realizzata in acciaio inox  
 Made of stainless steel  
 Réalisée en acier inoxydable  
 Hergestellt aus Edelstahl  
 Realizada en acero inox

Изготовлено из нержавеющей стали

21

lucida/  
 spazzolata  
 polished/  
 brushed



PR98

ø 7 x 10 cm



PR11

ø 11,2 x 2 cm



PR80

ø 5,5 x 19 cm



PR33

ø 10 x 38 cm





# G•NIGELLA

Realizzata in acciaio inox  
 Made of stainless steel  
 Réalisée en acier inoxydable  
 Hergestellt aus Edelstahl  
 Realizada en acero inox

38

Spazzolata  
 Brushed

Изготовлено из нержавеющей стали



NI98

ø 9 x 10 cm



NI11

ø 11 x 2,1 cm



NI81

ø 9 x 15,5 cm



NI33

ø 13 x 39 cm



Novità - New



# G•MARINA

Realizzata in ceramica e madreperla

Made of pottery and conch

Réalisée en céramique et nacre

Hergestellt aus Keramik und Perlmutter

Realizada en cerámica y nácar

Изготовлено из керамики и перламутра

03

Crema  
Cream



MR98

ø 8,5 x 11,3 cm



MR11

14 x 10 x 3,9 cm



MR80

ø 8,5 x 19 cm



MR33

ø 12,5 x 46 cm



# G•MYOSOTIS

Realizzata in ceramica e vetro

Made of pottery and glass

Réalisée en céramique et verre

Hergestellt aus Keramik und Glas

Realizada en cerámica y cristal

Изготовлено из керамики и стекла



03  
Crema/  
oro  
Cream/  
gold



73  
Grigio/  
argento  
Grey/  
silver



MY98

ø 8,5 x 11,3 cm



MY11

14 x 10 x 3,9 cm



MY80

ø 8,5 x 19 cm



MY33

ø 12,5 x 46 cm



# G•LUCREZIA

Realizzata in ceramica  
 Made of pottery  
 Réalisée en céramique  
 Hergestellt aus Keramik  
 Realizada en cerámica  
 Изготовлено из керамики

02

Bianco  
 White



LC98

7 x 7 x 11 cm



LC11

13 x 10 x 2,2 cm



LC80

7 x 7 x 17,5 cm



LC33

10 x 10 x 46 cm



# G•LUCY

Realizzata in ceramica  
 Made of pottery  
 Réalisée en céramique  
 Hergestellt aus Keramik  
 Realizada en cerámica  
 Изготовлено из керамики

02

Bianco  
 White



LY98

7,3 x 7,3 x 10,3 cm



LY11

12 x 8,2 x 3 cm



LY80

7,3 x 7,3 x 17,5 cm



LY33

9,7 x 9,7 x 47 cm





# G•RITA

Realizzata in ceramica  
 Made of pottery  
 Réalisée en céramique  
 Hergestellt aus Keramik  
 Realizada en cerámica  
 Изготовлено из керамики

02

Bianco  
 White



RI98

ø 7 x 10,5 cm



RI11

13 x 9,5 x 3,5 cm



RI80

ø 7 x 17 cm



RI33

ø 9 x 45 cm



# G•NEW MIZAR

Realizzata in ceramica  
 Made of pottery  
 Réalisée en céramique  
 Hergestellt aus Keramik  
 Realizada en cerámica  
 Изготовлено из керамики



**NM98**

ø 6,4 x 10,8 cm



**NM11**

12,3 x 9 x 3 cm



**NM80**

ø 6,4 x 19,2 cm



**NM33**

ø 9,7 x 47,5 cm





08

Grigio  
Grey

52

Tortora  
Turtledove  
grey

66

Tortora  
chiaro  
Light  
turtledove  
grey



# G•ASTRID

Realizzata in ceramica  
 Made of pottery  
 Réalisée en céramique  
 Hergestellt aus Keramik  
 Realizada en cerámica  
 Изготовлено из керамики

73

Argento  
Silver

87

Oro  
Gold

AD98

ø 8,3 x 11 cm



AD11

ø 12 x 2,6 cm



AD80

ø 8,3 x 16,6 cm



AD33

ø 11,5 x 47 cm



# G•NEW MARTINA

Realizzata in ceramica  
 Made of pottery  
 Réalisée en céramique  
 Hergestellt aus Keramik  
 Realizada en cerámica  
 Изготовлено из керамики

02

Bianco  
 White

73

Argento  
 Silver



MT 98

7,5 x 7,5 x 11 cm



MT 11

13 x 9 x 2,3 cm



MT 80

7,5 x 7,5 x 16 cm



MT 33

9 x 9 x 47 cm



# G•ILARY

Realizzata in ceramica e sughero

Made of pottery and cork

Réalisée en céramique et liège

Hergestellt aus Keramik und Kork

Realizada en cerámica y corcho

Изготовлено из керамики и пробки

02

Bianco  
White

14

Nero  
Black



IL98

ø 7 x 10,5 cm



IL11

13 x 9,5 x 3 cm



IL80

ø 7 x 17 cm



IL33

ø 8,8 x 46,5 cm



# G•NAOMI

Realizzata in ceramica  
 Made of pottery  
 Réalisée en céramique  
 Hergestellt aus Keramik  
 Realizada en cerámica  
 Изготовлено из керамики

08

Grigio  
 Grey

14

Nero  
 Black



NO98

ø 7,5 x 11,5 cm



NO11

13 x 9 x 2,5 cm



NO80

ø 7,5 x 18,5 cm



NO33

ø 9 x 45,5 cm



# G•SABINA

Realizzata in ceramica  
 Made of pottery  
 Réalisée en céramique  
 Hergestellt aus Keramik  
 Realizada en cerámica  
 Изготовлено из керамики

27

Acquamarina  
 Aquamarine



SA98

ø 7,5 x 11 cm



SA11

ø 12 x 2 cm



SA80

ø 7,5 x 19 cm



SA33

ø 9,3 x 46 cm





# G•CHANTAL

Realizzata in ceramica  
 Made of pottery  
 Réalisée en céramique  
 Hergestellt aus Keramik  
 Realizada en cerámica  
 Изготовлено из керамики

14

Nero  
 Black



CN98

ø 7 x 12 cm



CN11

12,8 x 8,3 x 2,5 cm



CN80

ø 7 x 20,6 cm



CN33

ø 11,5 x 46,5 cm



# G•MARIKA

Realizzata in ceramica  
 Made of pottery  
 Réalisée en céramique  
 Hergestellt aus Keramik  
 Realizada en cerámica  
 Изготовлено из керамики



**MK98**

ø 8 x 11,6 cm



**MK11**

12 x 8,3 x 3 cm



**MK80**

ø 8 x 18 cm



**MK33**

ø 10,2 x 45 cm



02

Bianco  
White

07

Verde  
salvia  
Green  
sage

08

Grigio  
Grey



# G•AZALEA

Realizzata in ceramica  
 Made of pottery  
 Réalisée en céramique  
 Hergestellt aus Keramik  
 Realizada en cerámica  
 Изготовлено из керамики



AZ98

∅ 9,8 x 13 cm



AZ11

12,4 x 9 x 2,7 cm



AZ80

∅ 10,2 x 17 cm



AZ33

∅ 16,5 x 40,3 cm



02

Bianco  
White

05

Blu  
Blue

79

Lilla  
Lilac



# G•CATHERINE

Realizzata in ceramica  
 Made of pottery  
 Réalisée en céramique  
 Hergestellt aus Keramik  
 Realizada en cerámica  
 Изготовлено из керамики

02

Bianco  
 White



CT98

ø 7,7 x 12 cm



CT11

13 x 7,8 x 1,8 cm



CT80

ø 7,7 x 19 cm



CT33

ø 9,8 x 40 cm





# G•AMELIE

Realizzata in ceramica  
 Made of pottery  
 Réalisée en céramique  
 Hergestellt aus Keramik  
 Realizada en cerámica  
 Изготовлено из керамики

02

Bianco  
 White



AM98

8 x 8 x 11,3 cm



AM11

13,5 x 8 x 5,8 cm



AM80

7,5 x 7,5 x 19 cm



AM33

10,4 x 10,4 x 48,5 cm



# G•CLOTHILDE

Realizzata in ceramica  
 Made of pottery  
 Réalisée en céramique  
 Hergestellt aus Keramik  
 Realizada en cerámica  
 Изготовлено из керамики

02

Bianco  
 White



CI98

ø 7,2 x 11,8 cm



CI11

12,7 x 8,8 x 2,9 cm



CI80

ø 7,2 x 20 cm



CI33

ø 9,6 x 46 cm



# G•VIVIENNE

Realizzata in ceramica  
 Made of pottery  
 Réalisée en céramique  
 Hergestellt aus Keramik  
 Realizada en cerámica  
 Изготовлено из керамики

**02**  
 Bianco  
 White

**05**  
 Blu  
 Blue



VV98

9,5 x 6 x 10,5 cm



VV11

13 x 8,4 x 3,2 cm



VV80

8,7 x 6 x 18 cm



VV33

9 x 9 x 47 cm





# G•VERBENA

Realizzata in ceramica  
 Made of pottery  
 Réalisée en céramique  
 Hergestellt aus Keramik  
 Realizada en cerámica  
 Изготовлено из керамики

02

Bianco  
 White



VE98

6,5 x 6,5 x 10 cm



VE11

11,5 x 8,5 x 2,5 cm



VE81

6,5 x 6,5 x 16,5 cm



VE33

cm 7,8 x 7,8 x 45,6



# G•DALIA

Realizzata in ceramica  
 Made of pottery  
 Réalisée en céramique  
 Hergestellt aus Keramik  
 Realizada en cerámica  
 Изготовлено из керамики

02

Bianco  
 White



DA98

ø 8,1 x 10,6 cm



DA11

ø 12,5 x 3,2 cm



DA80

ø 9 x 17,8 cm



DA33

ø 12,5 x 38 cm



# G•PETUNIA

Realizzata in ceramica e acciaio inox  
 Made of pottery and stainless steel  
 Réalisée en céramique et acier inoxydable  
 Hergestellt aus Keramik und Edelstahl  
 Realizada en cerámica y acero inox  
 Изготовлено из керамики и нержавеющей стали

02

Bianco  
 White



PE98

ø 7,5 x 9,5 cm



PE11

12,5 x 8,5 x 3,5 cm



PE81

ø 7,5 x 16,5 cm



PE33

ø 9 x 44,8 cm





# G•GINEVRA

Serie in cemento  
 Made of concrete  
 Réalisée en béton  
 Hergestellt aus Zement  
 Realizada en cemento  
 Изготовлено из бетона

08

Grigio  
 Grey



GN98

ø 7 x 10 cm



GN11

12,6 x 8 x 2 cm



GN80

ø 7 x 15,8 cm



GN33

ø 10 x 46,7 cm



# G•NORA

Realizzata in resina e bambù  
 Made of resin and bamboo  
 Réalisée en résine et bambou  
 Hergestellt aus Harz und Bambus  
 Realizada en resina y bambú  
 Изготовлено из бамбука и смол

08

Grigio  
Grey

NR98

8,5 x 8,5 x 12 cm



NR11

13 x 8,5 x 2,5 cm



NR80

9,8 x 4,6 x 14,6 cm



NR33

10,5 x 10,5 x 46 cm



Novità - New

# G•SOFIA

Realizzata in resina e sabbia  
 Made of resin and sand  
 Réalisée en résine et sable  
 Hergestellt aus Harz und Sand  
 Realizada en resina y arena  
 Изготовлено из смол и песка

02

Bianco  
 lucido  
 Lacquered  
 white

14

Nero matt  
 Matt  
 black



SF98

7,4 x 7,4 x 11 cm



SF11

10,9 x 6,9 x 2,9 cm



SF80

7,3 x 8,4 x 17,3 cm



SF33

9,4 x 9,4 x 47,2 cm



# G•ARIES

Realizzata in resina e sabbia  
 Made of resin and sand  
 Réalisée en résine et sable  
 Hergestellt aus Harz und Sand  
 Realizada en resina y arena  
 Изготовлено из смол и песчаника

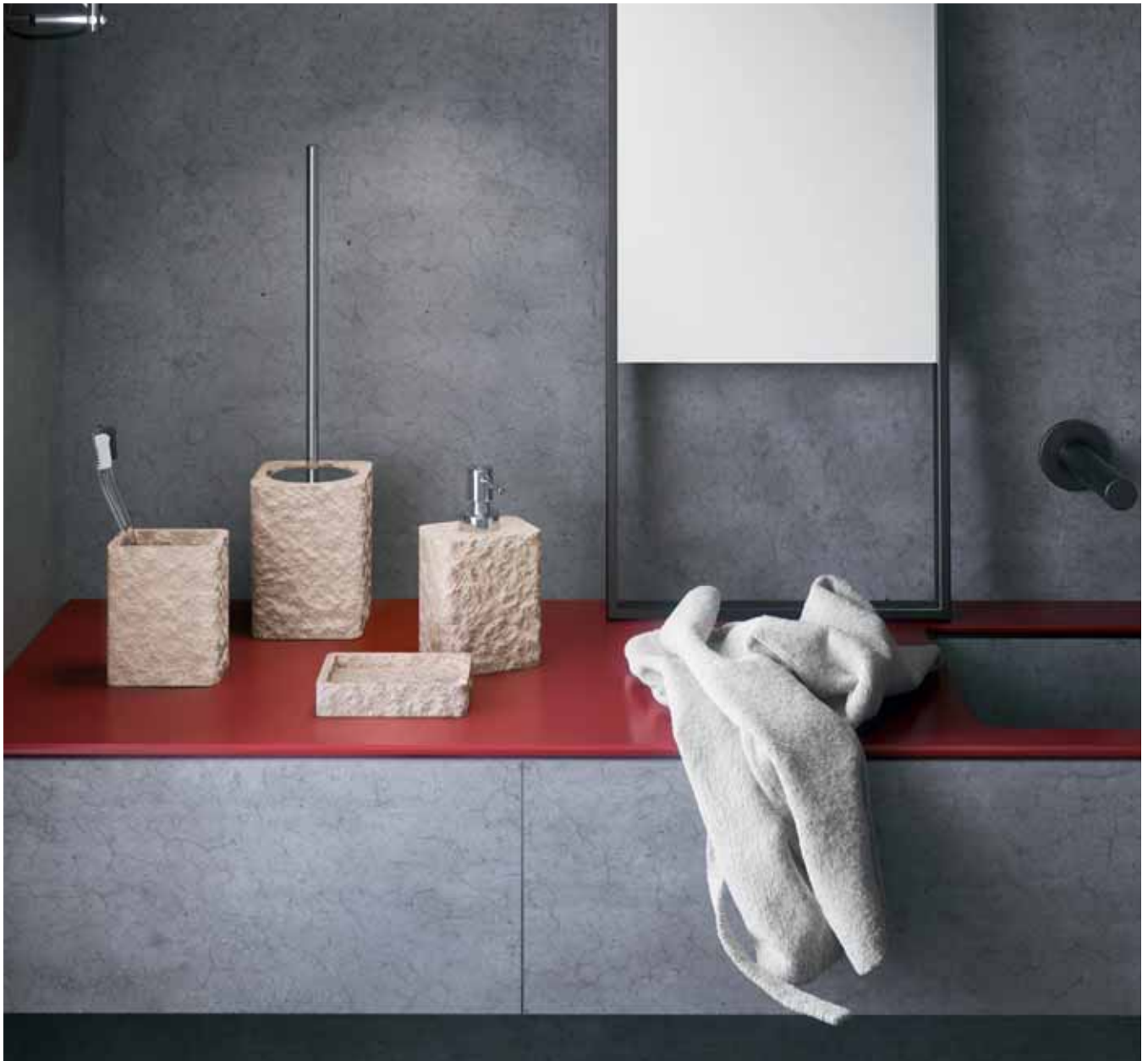

AR98

9,2 x 6,5 x 11 cm



AR11

12,2 x 8,6 x 2,4 cm



AR80

9 x 6,4 x 16,8 cm



AR33

10,5 x 10,5 x 40 cm



03

Beige

08

Grigio  
Grey

85

Antracite  
Anthracite





# G•LIBRA

Realizzata in resina e sabbia  
 Made of resin and sand  
 Réalisée en résine et sable  
 Hergestellt aus Harz und Sand  
 Realizada en resina y arena  
 Изготовлено из смол и песчаника

03

Beige



LB98

8,2 x 8,4 x 10,4 cm



LB11

14,7 x 14 x 3,2 cm



LB81

9,6 x 10,7 x 17,5 cm



LB33

12,1 x 12,5 x 41,6 cm





# G•AQUARIUS

Realizzata in resina  
 Made of resin  
 Réalisée en résine  
 Hergestellt aus Harz  
 Realizada en resina  
 Изготовлено из смол

03

Beige



AQ98

8,5 x 8,5 x 10,3 cm



AQ11

12,7 x 12,7 x 2,8 cm



AQ80

8,9 x 8,6 x 18 cm



AQ33

10,9 x 10,7 x 40 cm



# G•GEMINI

Realizzata in resina  
 Made of resin  
 Réalisée en résine  
 Hergestellt aus Harz  
 Realizada en resina  
 Изготовлено из смол



**GM98**

ø 8,7 x 11,1 cm



**GM11**

14 x 9,6 x 2,8 cm



**GM80**

8,6 x 9,4 x 20,7 cm



**GM33**

ø 9,9 x 45,7 cm



02

Bianco  
White

08

Grigio  
Grey

52

Tortora  
Turtledove  
grey



## G•ETNICA

Realizzata in resina  
 Made of resin  
 Réalisée en résine  
 Hergestellt aus Harz  
 Realizada en resina  
 Изготовлено из смол

29

Moka



ET98

8 x 8 x 10,4 cm



ET11

12,6 x 8,2 x 2,2 cm



ET81

7,9 x 7,9 x 15,7 cm



ET33

10 x 10 x 36 cm





# G•PETRA

Realizzata in resina  
 Made of resin  
 Réalisée en résine  
 Hergestellt aus Harz  
 Realizada en resina  
 Изготовлено из смол

08

Grigio  
 Grey



PT98

ø 7,5 x 11 cm



PT11

13,7 x 10 x 2,4 cm



PT80

ø 7,5 x 15,8 cm



PT33

ø 9 x 44,5 cm



# G•QUADROTTTO

Realizzata in resina  
 Made of resin  
 Réalisée en résine  
 Hergestellt aus Harz  
 Realizada en resina  
 Изготовлено из смол



QU98

10 x 6,5 x 11,2 cm



QU11

11,2 x 11,2 x 2,4 cm



QU81

8,2 x 8,2 x 16 cm



QU33

9,5 x 9,5 x 46 cm





**02**

Bianco  
White

**08**

Grigio  
Grey

**14**

Nero  
Black

**66**

Tortora  
chiaro  
Light  
turtledove  
grey



# G•SOLE

Realizzata in resina  
 Made of resin  
 Réalisée en résine  
 Hergestellt aus Harz  
 Realizada en resina  
 Изготовлено из смол



SL98

ø 7,2 x 12,2 cm



SL11

ø 11 x 2,9 cm



SL80

ø 7,2 x 15,7 cm



SL33

ø 9,8 x 40 cm



- 11 Azzurro Light blue
- 63 Viola Purple
- 67 Arancio Orange



# G•IDRA

Realizzata in resina  
 Made of resin  
 Réalisée en résine  
 Hergestellt aus Harz  
 Realizada en resina  
 Изготовлено из смол

03

Beige



ID98

ø 10,2 x 10,4 cm



ID11

12,3 x 9 x 2,7 cm



ID80

ø 10,6 x 15,5 cm



ID33

ø 12,2 x 40 cm



# G•OLIMPIA

Realizzata in resina  
 Made of resin  
 Réalisée en résine  
 Hergestellt aus Harz  
 Realizada en resina  
 Изготовлено из смол

73  
 Argento  
 Silver

87  
 Oro  
 Gold



OM98

ø 7,5 x 11 cm



OM11

13,8 x 9,5 x 2,2 cm



OM80

ø 7,5 x 19,6 cm



OM33

ø 9,5 x 45 cm



Novità - New

G•DORI

Realizzata in resina  
 Made of resin  
 Réalisée en résine  
 Hergestellt aus Harz  
 Realizada en resina  
 Изготовлено из смол

92

Turchese  
 Turquoise



DR98

ø 8,6 x 10,6 cm



DR11

17,5 x 11,7 x 1,7 cm



DR80

13,6 x 10,2 x 16,4 cm



DR33

11,3 x 9,5 x 37,8 cm





# G•GRAZIA

Realizzata in resina  
 Made of resin  
 Réalisée en résine  
 Hergestellt aus Harz  
 Realizada en resina  
 Изготовлено из смол

02

Bianco  
 White



GR98

ø 8 x 10,6 cm



GR11

13,8 x 9,5 x 2,8 cm



GR80

12 x 7,3 x 17 cm



GR33

ø 11 x 46,7 cm



# G•SELINA

Realizzata in resina  
 Made of resin  
 Réalisée en résine  
 Hergestellt aus Harz  
 Realizada en resina  
 Изготовлено из смол



Multicolore  
 Multicolor



SE98

13 x 7,8 x 10 cm



SE11

12,5 x 9,7 x 1,6 cm



SE80

ø 8 x 18 cm



SE33

ø 9,5 x 47 cm



# G•TWIST

Design: Babled & Co.

**S2**

Bianco  
White

**73**

Argento  
Silver

**79**

Lilla  
Lilac

Realizzata in resina  
Made of resin  
Réalisée en résine  
Hergestellt aus Harz  
Realizada en resina  
Изготовлено из смол



4698

8,5 x 8,5 x 12 cm



4611

13 x 9 x 3,5 cm



4681

8,5 x 8,5 x 17,5 cm



4633

12 x 13,5 x 47 cm



# G•CHANELLE

Realizzata in resina  
 Made of resin  
 Réalisée en résine  
 Hergestellt aus Harz  
 Realizada en resina  
 Изготовлено из смол



CH98

9 x 7 x 10,5 cm



CH11

12 x 7,8 x 2,8 cm



CH80

11,5 x 7,8 x 12,6 cm



CH33

10,6 x 8,6 x 45,7 cm



**02**

Bianco  
White

**07**

Verde  
menta  
Green  
mint

**10**

Rosa  
Pink

**37**

Pesca  
Peach  
color

**66**

Tortora  
chiaro  
Light  
turtledove  
grey





# G•ANTARES

Realizzata in resina  
 Made of resin  
 Réalisée en résine  
 Hergestellt aus Harz  
 Realizada en resina  
 Изготовлено из смол



AT98

8 x 6,2 x 11,7 cm



AT11

11,2 x 7,5 x 2,7 cm



AT80

8 x 6,2 x 15,5 cm



AT33

8,7 x 8 x 47 cm





**T2**

Bianco  
White

**T5**

Blu  
Blue

**T6**

Marrone  
Brown

**T8**

Grigio  
Grey



# G•RAINBOW

Realizzata in resina  
 Made of resin  
 Réalisée en résine  
 Hergestellt aus Harz  
 Realizada en resina  
 Изготовлено из смол



**RA00**

19 x 11 x 7,5 cm



**RA98**

7,2 x 7,2 x 11 cm



**RA11**

11 x 7 x 3 cm



**RA81**

7 x 7 x 16,2 cm



**RA33**

9,8 x 9,8 x 37,5 cm



- 02**

Bianco  
White
- 04**

Verde acido  
Acid green
- 05**

Blu  
Blue
- 06**

Rosso  
Red
- 14**

Nero  
Black
- 67**

Arancio  
Orange
- 73**

Argento  
Silver
- 79**

Lilla  
Lilac
- 52**

Tortora  
Turtledove  
grey
- 66**

Tortora chiaro  
Light  
turtledove  
grey



**RA80      RA02      RA08**

7 x 11,3 x 17,2 cm      14,5 x 14,5 x 15 cm      25 x 13,5 x 7,5 cm

- 02**

Bianco  
White
- 04**

Verde acido  
Acid green
- 05**

Blu  
Blue
- 06**

Rosso  
Red
- 14**

Nero  
Black
- 67**

Arancio  
Orange
- 73**

Argento  
Silver
- 79**

Lilla  
Lilac

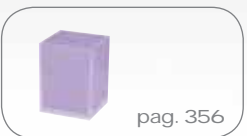

# G•GIULIA

Realizzata in resina  
 Made of resin  
 Réalisée en résine  
 Hergestellt aus Harz  
 Realizada en resina  
 Изготовлено из смол

**T2**

Bianco  
 White

**T6**

Marrone  
 Brown



**GU98**

7 x 7 x 11 cm



**GU11**

10,6 x 6,8 x 2 cm

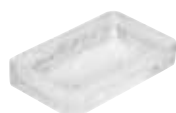

**GU80**

7 x 7 x 16 cm



**GU33**

9,2 x 9,2 x 46 cm



# G•VEGA

Realizzata in resina  
 Made of resin  
 Réalisée en résine  
 Hergestellt aus Harz  
 Realizada en resina  
 Изготовлено из смол

02

Bianco  
 White

73

Argento  
 Silver



VG98

ø 7 x 12 cm



VG11

ø 11 x 2,5 cm



VG80

ø 7 x 15,7 cm



VG33

ø 10 x 37 cm



# G•FLOU

Design: Carallo\_Grandis

02

Bianco  
White

05

Turchese  
trasparente  
Transparent  
turquoise

Realizzata in resine termoplastiche  
Made of thermoplastic resins  
Réalisée en thermoplastique  
Hergestellt aus Kunststoff  
Realizada en resina termoplásticas  
Изготовлено из термопластичных смол



1798

ø 10,2 x 11,2 cm



1711

13,8 x 12,5 x 4 cm



1780

ø 11 x 19 cm



1733

ø 12,6 x 36 cm







73

Argento  
Silver

# G•LUNA

Realizzata in resine termoplastiche  
 Made of thermoplastic resins  
 Réalisée en thermoplastique  
 Hergestellt aus Kunststoff  
 Realizada en resina termoplásticas  
 Изготовлено из термопластичных смол



LU98

ø 7,2 x 12,9 cm



LU11

ø 11,5 x 2,4 cm



LU80

ø 7,2 x 15,2 cm



LU33

ø 8,7 x 47 cm



# G•GLADY

Realizzata in resine termoplastiche  
 Made of thermoplastic resins  
 Réalisée en thermoplastique  
 Hergestellt aus Kunststoff  
 Realizada en resina termoplásticas  
 Изготовлено из термопластиченых смол



GL98

ø 8,5 x 11 cm



GL11

12,3 x 8 x 2,5 cm



GL80

ø 8,5 x 17 cm



GL33

ø 13,2 x 40,5 cm



<b>00</b>	<b>02</b>	<b>05</b>	<b>29</b>	<b>67</b>	<b>76</b>	<b>79</b>	<b>85</b>	<b>92</b>
Trasparente Transparent	Bianco White	Blu Blue	Moka Moka	Arancio Orange	Fucsia Fuchsia	Lilla Lilac	Antracite Anthracite	Turchese Turquoise

NEW

<b>04</b>
Verde acido Acid green



## GLOO

18,5 x 10,5 x 7,5 cm

**00**

Trasparente  
Transparent



pag. 358

# G•SEVENTY

Design: Matteo Thun ✦

Realizzata in resine termoplastiche  
 Made of thermoplastic resins  
 Réalisée en thermoplastique  
 Hergestellt aus Kunststoff  
 Realizada en resina termoplásticas  
 Изготовлено из термопластиченых смол



6398

6,5 x 6,5 x 12,2 cm



6311

12,4 x 8 x 2,1 cm



6382

6,5 x 6,5 x 16 cm



6334

9 x 9 x 38,8 cm



- 08**  
Grigio  
Grey
- 22**  
Bianco  
White
- 52**  
Tortora  
Turtledove  
grey
- 79**  
Lilla  
Lilac
- 66**  
Beige  
Beige

NEW

- V7**  
Verde  
pistacchio  
Pistachio  
green

100%  
made in Italy





# G•MOBY

Realizzata in resine termoplastiche  
 Made of thermoplastic resins  
 Réalisée en thermoplastique  
 Hergestellt aus Kunststoff  
 Realizada en resina termoplásticas  
 Изготовлено из термопластиченых смол



3198

8,7 x 8,3 x 11,5 cm



3111

15 x 12 x 5,5 cm



3182

8,7 x 8,3 x 16,5 cm



3133

11,1 x 10,9 x 37,8 cm

100%  
made in Italy







02  
Bianco  
White



48  
Bianco/  
tortora  
White/  
turtledove



58  
Bianco/  
Tortora chiaro  
White/light  
turtledove  
grey



71  
Bianco/  
grigio  
White/  
grey



89  
Bianco/  
blu  
White/  
blue



Novità - New

## G•PIXIS

Realizzata in resine termoplastiche

Made of thermoplastic resins

Réalisée en thermoplastique

Hergestellt aus Kunststoff

Realizada en resina termoplásticas

Изготовлено из термопластиченых смол



Bianco/  
blu  
White/  
blue



PY10

ø 7,2 x 12 cm



PY11

11 x 7,6 x 3,3 cm



PY80

ø 7 x 18,5 cm



PY33

ø 10,2 x 35 cm



BEAUTY



# Specchi senza luci

Mirrors without lights - Miroirs sans éclairage  
Spiegel ohne Beleuchtung - Espejos sin luces - Зеркала без подсветки



**2551 \***

100 x 2 x 60 cm

**Specchio filo lucido**

Polished edge mirror

Miroir bord poli

Spiegel mit polierter Kante

Espejo canto pulido

Зеркало с полированными краями

**100%**  
made in Italy



**2561 \***

100 x 2 x 60 cm

**Specchio bisellato**

Bevelled mirror

Miroir biseauté

Spiegel mit Facettenschliff

Espejo biselado

Зеркало со скшенными краями

**100%**  
made in Italy



\* Montabile anche in posizione verticale - Can be mounted upright  
Montable aussi en position verticale  
Senkrecht aufhängbar auch - Puede montarse también verticalmente  
Монтаж тоже в вертикальном положении



**2575 \***

75 x 2 x 55 cm

**Specchio filo lucido**

Polished edge mirror

Miroir bord poli

Spiegel mit polierter Kante

Espejo canto pulido

Зеркало с полированными краями

**100%**  
made in Italy



**2585 \***

75 x 2 x 55 cm

**Specchio bisellato**

Bevelled mirror

Miroir biseauté

Spiegel mit Facettenschliff

Espejo biselado

Зеркало со скшенными краями

**100%**  
made in Italy



\* Montabile anche in posizione verticale - Can be mounted upright  
Montable aussi en position verticale  
Senkrecht aufhängbar auch - Puede montarse también verticalmente  
Монтаж тоже в вертикальном положении

**2520**

ø 65 x 2 cm

**Specchio filo lucido**

Polished edge mirror

Miroir bord poli

Spiegel mit polierter Kante

Espejo canto pulido

Зеркало с полированными

краями

100%  
made in Italy**2530**

ø 65 x 2 cm

**Specchio bisellato**

Bevelled mirror

Miroir biseauté

Spiegel mit Facettenschliff

Espejo biselado

Зеркало со скшенными

краями

100%  
made in Italy**2540\***

50 x 2 x 80 cm

**2550\***

60 x 2 x 70 cm

**Specchio filo lucido**

Polished edge mirror

Miroir bord poli

Spiegel mit polierter Kante

Espejo canto pulido

Зеркало с полированными краями

100%  
made in Italy**2545\***

50 x 2 x 80 cm

**2560\***

60 x 2 x 70 cm

**Specchio bisellato**

Bevelled mirror

Miroir biseauté

Spiegel mit Facettenschliff

Espejo biselado

Зеркало со скшенными краями

100%  
made in Italy

\* Montabile anche in posizione orizzontale - Can be mounted horizontally  
 Montable aussi en position horizontale  
 Kann auch quer aufgehängt werden - Puede montarse también  
 horizontalmente - Монтаж тоже в горизонтальном положении

**8400 G•DAKOTA**

Design: Carlo Vietri

50 x 2 x 65 cm

**100%**  
 made in Italy  

**Specchio filo lucido**

Polished edge mirror

Miroir bord poli

Spiegel mit polierter Kante

Espejo canto pulido

Зеркало с полированными краями

 Montabile anche in posizione orizzontale - Can be mounted horizontally  
 Montable aussi en position horizontale  
 Kann auch quer aufgehängt werden - Puede montarse también  
 horizontalmente - Монтаж тоже в горизонтальном положении
**7800 G•MAINE**

60 x 3 x 70 cm

**100%**  
 made in Italy  

**Specchio con bordo laccato**

Mirror with lacquered frame

Miroir avec cadre laqué

Spiegel mit lackiertem Rahmen

Espejo con marco lacado

Зеркало с лакированной рамой

**05**Blu  
Blue**67**Arancio  
Orange**73**Argento  
Silver**76**Fucsia  
Fuchsia
 Montabile anche in posizione orizzontale - Can be mounted horizontally  
 Montable aussi en position horizontale  
 Kann auch quer aufgehängt werden - Puede montarse también  
 horizontalmente - Монтаж тоже в горизонтальном положении





**2604**

60 x 6 x 70 cm

**100%**  
made in Italy

**Specchio**  
Mirror  
Miroir  
Spiegel  
Espejo  
Зеркало



**6000**

ø 60 x 3 cm

**100%**  
made in Italy

**Specchio**  
Mirror  
Miroir  
Spiegel  
Espejo  
Зеркало



**6004**

55 x 3 x 55 cm

**Specchio**  
 Mirror  
 Miroir  
 Spiegel  
 Espejo  
 Зеркало

**100%**  
 made in Italy



**2901**

45 x 14,7 x 60 cm

**Specchio con mensola**  
 Mirror with shelf  
 Miroir avec étagère  
 Spiegel mit Ablage  
 Espejo con estante  
 Зеркало со полочка

**100%**  
 made in Italy



**2900**

45 x 4 x 45 cm

**Specchio**  
 Mirror  
 Miroir  
 Spiegel  
 Espejo  
 Зеркало

**100%**  
 made in Italy



**8000**

**Design:**  
**Gianpietro Tonetti**

55 x 3,5 x 60 cm

**Specchio**  
 Mirror  
 Miroir  
 Spiegel  
 Espejo  
 Зеркало

**100%**  
 made in Italy



# Specchi con luci

Mirrors with lights - Miroirs avec éclairage  
Spiegel mit Beleuchtung - Espejos con luces - Зеркала со светильником

Luci non incluse - Lights not included



**8401 G•DAKOTA**

Design: Carlo Vietri

50 x 6 x 65 cm

100%  
made in Italy

**Specchio filo lucido**

Polished edge mirror

Miroir bord poli

Spiegel mit polierter Kante

Espejo canto pulido

Зеркало с полированными краями

CE

IP 20 

W25 - E14



**2605**

60 x 6,6 x 70 cm

100%  
made in Italy

**Specchio**

Mirror

Miroir

Spiegel

Espejo

Зеркало

CE

IP 20 

W25 - E14



**6001**

ø 60 x 5 cm

**Specchio**  
 Mirror  
 Miroir  
 Spiegel  
 Espejo  
 Зеркало

**100%**  
 made in Italy

CE  
 IP 20   
 W25 - E14



**6005**

55 x 5 x 55 cm

**Specchio**  
 Mirror  
 Miroir  
 Spiegel  
 Espejo  
 Зеркало

**100%**  
 made in Italy

CE  
 IP 20   
 W25 - E14



2903

45 x 14,7 x 60 cm

**Specchio con mensola**

Mirror with shelf

Miroir avec étagère

Spiegel mit Ablage

Espejo con estante

Зеркало со полочка

CE

IP 20 

W25 - E14

100%  
made in Italy  

8001

**Design:**  
Gianpietro Tonetti

55 x 5,5 x 60 cm

**Specchio**

Mirror

Miroir

Spiegel

Espejo

Зеркало

CE

IP 20 

W25 - E14

100%  
made in Italy  



13

Lucido  
Polished

## Armadietti in acciaio inox

Cabinets made of stainless steel - Armoires en acier inoxydable  
Hängeschränken aus Edelstahl - Armarios en acero inox Шкаф изготовлено из нержавеющей стали



2807

51 x 11,5 x 64,5 cm

**Con anta a specchio reversibile e 1 ripiano acciaio inox/vetro**

With reversible mirror door and 1 shelf stainless steel/glass

Avec porte à miroir réversible et 1 étagère acier inoxydable/verre

Mit reversibler Spiegeltür und 1 Ablage Edelstahl/Glas

Con puerta de espejo reversible y 1 repisa acero inox/cristal

С реверсивной зеркальной дверцей и 1 полочка нержавеющей стали/стекла

Lampada non inclusa - Lamp not included



2806

51 x 11,5 x 60 cm

**Con anta a specchio reversibile e 1 ripiano acciaio inox/vetro**

With reversible mirror door and 1 shelf stainless steel/glass

Avec porte à miroir réversible et 1 étagère acier inoxydable/verre

Mit reversibler Spiegeltür und 1 Ablage Edelstahl/Glas

Con puerta de espejo reversible y 1 repisa acero inox/cristal

С реверсивной зеркальной дверцей и 1 полочка нержавеющей стали/стекла



### KO07 G•KORA

46 x 12 x 66 cm

**Armadietto reversibile con antina a specchio scorrevole - acciaio inox AISI 304**

Cabinet with sliding mirror door in AISI 304 stainless steel

Armoire reversible avec porte à miroir coulissante acier inoxydable AISI 304

Schrankchen, reversibel, mit Spiegel-Schiebetür Edelstahl AISI 304

Armario reversible con puerta de espejo corredera - acero inox AISI 304

Шкафчик с зеркальной раздвижной дверцей нержавеющей сталь AISI 304



### JO07 G•JOKER

30 x 12 x 50 cm

### JO35 G•JOKER

30 x 12 x 30 cm

**Armadietti con anta in vetro, serratura di sicurezza e 1 ripiano - acciaio inox/vetro**

Cabinets with glass door, safety lock and 1 shelf stainless steel/glass

Armoires avec porte vitrée, serrure de sécurité et 1 étagère - acier inox/verre

Schränkchen mit Glastür, Sicherheitsschloss und 1 Ablage - Edelstahl/Glas

Armarios con puerta de cristal, cerradura de seguridad y 1 repisa - acero inoxidable/cristal

Шкафчик со стеклянной створкой, замком и 1 полочка - нержавеющая сталь/стекло

02

Bianco  
White

# Armadietti in resine termoplastiche

Cabinets in thermoplastic resins - Armoires en thermoplastique - Hängeschränken aus thermoplastischem Kunststoff  
Armarios en resinas termoplásticas - Шкаф изготовлено из термопластичных смол



8047 G•PRINCESS

100%  
made in Italy

58,5 x 14 x 38 cm

**Con 3 ante a specchio**

With 3 mirror doors

Avec 3 portes à miroir

Mit 3 Spiegeltüren

Con 3 puertas de espejo

С 3 зеркальными дверцами



8007 G•LILLIPUT

100%  
made in Italy

Design: Olaf Von Bohr

30 x 14,3 x 45 cm

**Con anta a specchio**

With mirror door - Avec porte à miroir

Mit Spiegeltür - Con puerta de espejo

С зеркальной дверцей



8035

100%  
made in Italy

25 x 12,5 x 39,5 cm

**Armadietto farmacia con chiave**

Medicine cabinet with key

Armoire à pharmacie avec clef

Arzneischrank mit Schlüssel

Botiquín con llave

Аптека закрывающаяся на ключ

# Specchi ingranditori

Magnifying mirrors - Miroirs grossissants - Kosmetikspiegel  
Espejos de aumento - Увеличительные зеркала



## HO08 G•HOT

13

ø 15 x 27max x 22 cm

Cromato  
Chromed



SOLO SU SUPERFICI LISCE (SPECCHI, PIASTRELLE)  
FOR FLAT SURFACES (MIRRORS, TILES) ONLY

**Specchio ingranditore e non, con fissaggio a ventosa - resine termoplastiche/metallo**

Magnifying and non-magnifying mirror with suction cup fixing - thermoplastic resins/metal

Miroir grossissant et non grossissant avec ventouse thermoplastique/métal

Spiegel mit und ohne Vergrößerung - mit Saugnapf-Befestigung - Kunststoff/Metall

Espejo de aumento y normal - fijación con ventosa - resinas termoplásticas/metall

Авчстороннее чвеличительное и обычное зеркало на присоска - термопластичные смоли/металл



## CO2021

13

ø 20 x 3 cm

Cromato  
Chromed



SOLO SU SUPERFICI LISCE (SPECCHI, PIASTRELLE)  
FOR FLAT SURFACES (MIRRORS, TILES) ONLY

**Specchio ingranditore con ventose metallo/vetro**

Magnifying mirror with suction cups metal/glass

Miroir grossissant avec ventouses métal/verre

Vergrößerungsspiegel mit Saugnapfen Metall/Glas

Espejo de aumento con ventosas metal/cristal

Увеличительное зеркало на присосках металл/стекло



## CO2020

13

ø 15 x 3 cm

Cromato  
Chromed



SOLO SU SUPERFICI LISCE (SPECCHI, PIASTRELLE)  
FOR FLAT SURFACES (MIRRORS, TILES) ONLY

**Specchio ingranditore con ventose metallo/vetro**

Magnifying mirror with suction cups metal/glass

Miroir grossissant avec ventouses métal/verre

Vergrößerungsspiegel mit Saugnapfen Metall/Glas

Espejo de aumento con ventosas metal/cristal

Увеличительное зеркало на присосках металл/стекло





### CO2019

20 x 11,8 x 32,3 cm

#### Ingranditore e non - metallo

Magnifying and non-magnifying - metal

Grossissant et non grossissant - métal

Mit und ohne Vergrößerung - Metall

De aumento y normal - metal

Двустороннее увеличительное и не увеличительное зеркало - металл

13

Cromato  
Chromed



### CO2023 G•MONICA

17,2 x 3,9 x 17,5 cm

#### Ingranditore e non - metallo

Magnifying and non-magnifying - metal

Grossissant et non grossissant - métal

Mit und ohne Vergrößerung - Metall

De aumento y normal - metal

Двустороннее увеличительное и не увеличительное зеркало - металл

02

Bianco  
White

13

Cromato  
Chromed

79

Lilla  
Lilac

5x

**CO2022 G•ELENA**

16,5 x 1,8 x 19 cm

**Ingranditore e non - resine termoplastiche**  
 Magnifying and non-magnifying mirror in thermoplastic resins  
 Grossissant et non grossissant - thermoplastique  
 Mit und ohne Vergrößerung - Kunststoff  
 De aumento y normal - resinas termoplásticas  
 Двустороннее увеличительное и обычное зеркало - термопластичная смола

02

Bianco  
White

76

Fucsia  
Fuchsia

92

Turchese  
Turquoise

2x

**CO2018**

17,6 x 10 x 25 cm

**Ingranditore e non - resine termoplastiche**  
 Magnifying and non-magnifying mirror in thermoplastic resins  
 Grossissant et non grossissant - thermoplastique  
 Mit und ohne Vergrößerung - Kunststoff  
 De aumento y normal - resinas termoplásticas  
 Двустороннее увеличительное и обычное зеркало - термопластичная смола

00

Trasparente  
Transparent

05

Blu  
Blue

79

Lilla  
Lilac

# Bilancia pesapersona elettronica

Electronic bathroom scale - Pèse-personne électronique - Elektronische Personenwaage  
 Báscula pesa-personas electrónica Весы электронные напольные

**RA90 G•RAINBOW**

34 x 27,4 x 2,7 cm

**Realizzata in vetro, metallo e resine termoplastiche**

In glass, metal and thermoplastic resins  
 Réalisé en verre, métal et thermoplastique  
 Hergestellt aus Glas, Metall und Kunststoff  
 Realizada en cristal, metal y resinas termoplásticas

Изготовлено из стекла, металла и термопластичных смол

04

Verde acido  
Acid green

05

Blu  
Blue

14

Nero  
Black

67

Arancio  
Orange



# HYGIENE



# Cestini in acciaio inox

Waste bins of stainless steel - Poubelles en acier inoxydable - Treteimer aus Edelstahl - Cubos de basura de acero inox - Урны из нержавеющей стали

## 2809 - Lt. 5

22,8 x 23,2 x 30 cm



13

Lucido  
Polished

## 2309 G•ARGENTA - Lt. 5

20,5 x 24 x 30 cm



13

Lucido  
Polished

## 2209 G•ARGENTA - Lt. 3

16,5 x 21,5 x 25 cm



13

Lucido  
Polished

## 2909 G•ARGENTA - Lt. 5

14 x 29,4 x 30 cm



13

Lucido  
Polished

## 2409 - Lt. 7

20,5 x 26,5 x 31,8 cm



13

Lucido  
Polished

## 2709 G•ARGENTA - Lt. 5

20,5 x 26,5 x 27,8 cm



13

Lucido  
Polished

## 2609 - Lt. 3

17 x 22,5 x 26 cm



13

Lucido  
Polished

Novità - New

# G•POTTY

02

Bianco matt  
Matt white

14

Nero matt  
Matt black

87

Oro matt  
Matt gold



3209 - Lt. 3

17,4 x 22,6 x 25,1 cm

3309 - Lt. 5

20,6 x 26,8 x 27,5 cm



# Cestini in resine termoplastiche

# G•RAINBOW

Waste bins in thermoplastic resins - Poubelles en thermoplastique  
 Treteimer aus Kunststoff - Cubos de basura de resinas termoplásticas  
 Урны из термопластичных смол



RA09 - Lt. 6

18 x 18 x 23,7 cm



02	04	05	06	14	67	73	79
Bianco White	Verde acido Acid green	Blu Blue	Rosso Red	Nero Black	Arancio Orange	Argento Silver	Lilla Lilac



100%  
made in Italy

# G•BOXER

Design: Makio Hasuike

357

02

Bianco  
White



2009 - Lt. 10,8

ø 22,5 x 31 cm



## G•GLADY

00

Trasparente  
Transparent

02

Bianco  
White

04

Verde acido  
Acid green

05

Blu  
Blue

GLO9 - Lt. 6,6

ø 21,1 x 25,4 cm





100%  
made in Italy

Novità - New

# G•SEVENTY

08

Grigio  
Grey

22

Bianco  
White

66

Beige  
Beige



6309 - Lt. 8

20 x 20 x 24,6 cm



100%  
made in Italy

Novità - New

G•EYE

02

Bianco  
White



1209 - Lt. 6

ø 19 x 26,5 cm



## 1009 G•PENG- Lt. 7,5

Design: Pedrizzetti e Associati

22,9 x 23,8 x 34,5 cm



100%  
made in Italy



Bianco/Nero  
White/Black

## 8009 G•JUNIOR - Lt. 4,8

Design: Olaf Von Bohr

21 x 15 x 34 cm



100%  
made in Italy



Bianco  
White



Grigio  
Grey



Tortora  
Turtledove  
grey



Beige  
Beige

## 8609 G•VENEZIA - Lt. 6

ø 23 x 24,5 cm



100%  
made in Italy



Bianco  
White

# Scopini wc in metallo

Metal toilet brushes - Porte-brosse en métal - WC-Bürstengarnituren aus Metall  
Escobilleros en metal - Туалетный ёршик из металла

## NE33/O3 G•NEMESIA

9 x 9,5 x 38 cm



Da muro  
Wall brush holder  
Mural  
Bürstengarnitur  
mit Wandhalterung  
De pared  
Настенный ёршик

**13**  
Lucido  
Polished

**Acciaio inox**  
Stainless steel  
Acier inoxydable  
Edelstahl  
Acero inox  
Нержавеющая сталь

## ED34/O3 G•EDERA

ø 7,5 x 7,8 x 40 cm



Da muro  
Wall brush holder  
Mural  
Bürstengarnitur  
mit Wandhalterung  
De pared  
Настенный ёршик

**13**  
Lucido  
Polished

**Acciaio inox**  
Stainless steel  
Acier inoxydable  
Edelstahl  
Acero inox  
Нержавеющая сталь

## 2733/O3 G•ASCOT

ø 8,5 x 9 x 38 cm



Da muro  
Wall brush holder  
Mural  
Bürstengarnitur  
mit Wandhalterung  
De pared  
Настенный ёршик

**13**  
Lucido  
Polished

**Acciaio inox**  
Stainless steel  
Acier inoxydable  
Edelstahl  
Acero inox  
Нержавеющая сталь

## 7533 G•ROMANCE

ø 9 x 41 cm



**44**  
Bronzo  
Bronze

**Acciaio inox/Cromall®**  
Stainless steel/Cromall®  
Acier inoxydable/Cromall®  
Edelstahl/Cromall®  
Acero inox/Cromall®  
Нержавеющая сталь/Cromall®

## 3833 G•KANSAS

8,7 x 8,7 x 36 cm



**13**  
Lucido  
Polished

**Acciaio inox**  
Stainless steel  
Acier inoxydable  
Edelstahl  
Acero inox  
Нержавеющая сталь

## EE33 G•ELETTRA

ø 8 x 46,8 cm



**15**  
Rame  
Copper

**Acciaio inox**  
Stainless steel  
Acier inoxydable  
Edelstahl  
Acero inox  
Нержавеющая сталь

## 2133 G•WINNY

ø 9 x 38 cm



**13**  
Lucido  
Polished

**Acciaio inox**  
Stainless steel  
Acier inoxydable  
Edelstahl  
Acero inox  
Нержавеющая сталь

## NE33 G•NEMESIA

9 x 9 x 38 cm



**13**  
Lucido  
Polished

**Acciaio inox**  
Stainless steel  
Acier inoxydable  
Edelstahl  
Acero inox  
Нержавеющая сталь

## PR33 G•PRIMULA

ø 10 x 38 cm



**21**  
Lucido  
spazzolato  
Polished/  
brushed

**Acciaio inox**  
Stainless steel  
Acier inoxydable  
Edelstahl  
Acero inox  
Нержавеющая сталь

**ED34 G•EDERA**

ø 7,5 x 40 cm

**13**Lucido  
Polished

**Acciaio inox**  
Stainless steel  
Acier inoxydable  
Edelstahl  
Acero inox  
Нержавеющая сталь

**GE33 G•GENZIANA**

ø 7,5 x 33 cm

**13**Lucido  
Polished**02**Bianco  
White

**Acciaio inox**  
Stainless steel  
Acier inoxydable  
Edelstahl  
Acero inox  
Нержавеющая сталь

**FE33 G•FELCE**

ø 7,5 x 33 cm

**13**Lucido  
Polished

**Acciaio inox**  
Stainless steel  
Acier inoxydable  
Edelstahl  
Acero inox  
Нержавеющая сталь

**2733 G•ASCOT**

ø 8,5 x 38 cm

**13**Lucido  
Polished

**Acciaio inox**  
Stainless steel  
Acier inoxydable  
Edelstahl  
Acero inox  
Нержавеющая сталь

**5233 G•FLIP**

Design: Piet Billekens

ø 9,1 x 37,7 cm

**02**Bianco  
White**Novità - New****13**Lucido  
Polished**14**Nero matt  
Matt black

**Acciaio**  
Steel  
Acier  
Stahl  
Acero  
Сталь

**DS33 G•DIASPRO**

ø 10 x 38,5 cm

**13**Cromato  
Chromed

**Acciaio inox**  
Stainless steel  
Acier inoxydable  
Edelstahl  
Acero inox  
Нержавеющая сталь

**CO34 G•ORIENTE**

ø 9,5 x 37 cm

**13**Lucido  
Polished

**Acciaio inox**  
Stainless steel  
Acier inoxydable  
Edelstahl  
Acero inox  
Нержавеющая сталь

# Scopini wc in vetro e ceramica

Glass and pottery toilet brushes - Porte-brosse en verre céramique - WC-Bürstengarnituren aus Glas und Keramik  
Escobilleros en cristal y cerámica- Туалетный ершик из стекла и керамики

## 5733/O3 G•GLAMOUR

10 x 13 x 39 cm



Da muro  
Wall brush holder  
À mur  
Wandbürstengarnitur  
De pared  
Настенный ёршик

**Cromall®/vetro**  
Cromall®/glass  
Cromall®/verre  
Cromall®/Glas  
Cromall®/cristal  
Cromall®/стекла

13

Cromato  
Chromed

## PI33/O3 G•PIRENEI

8,5 x 10,9 x 36,5 cm



Da muro  
Wall brush holder  
À mur  
Wandbürstengarnitur  
De pared  
Настенный ёршик

**Ottone/Cromall®/vetro**  
Brass/Cromall®/glass  
Laiton/Cromall®/verre  
Messing/Cromall®/Glas  
Latón/Cromall®/cristal  
Латуни/Cromall®/стекла

13

Cromato  
Chromed

14

Nero matt  
Matt black

## 5533 G•KENT

9,7 x 9 x 36,2 cm



**Cromall®/vetro**  
Cromall®/glass  
Cromall®/verre  
Cromall®/Glas  
Cromall®/cristal  
Cromall®/стекла

13

Lucido  
Polished

## 5733 G•GLAMOUR

10 x 10 x 39 cm



**Cromall®/vetro**  
Cromall®/glass  
Cromall®/verre  
Cromall®/Glas  
Cromall®/cristal  
Cromall®/стекла

02

Bianco  
White

## PE33 G•PETUNIA

ø 9 x 44,8 cm



**Acciaio inox/ceramica/resine termoplastiche**  
Stainless steel/pottery/thermoplastic resins  
Acier inoxydable/céramique/thermoplastique  
Edelstahl/Keramik/Kunststoff  
Acero inox/cerámica/resinas termoplásticas  
Нержавеющая сталь/керамики/  
термопластичные смолы

02

Bianco  
White

## VE33 G•VERBENA

ø 7,8 x 7,8 x 45,6 cm



**Acciaio inox/ceramica/resine termoplastiche**  
Stainless steel/pottery/thermoplastic resins  
Acier inoxydable/céramique/thermoplastique  
Edelstahl/Keramik/Kunststoff  
Acero inox/cerámica/resinas termoplásticas  
Нержавеющая сталь/керамики/  
термопластичные смолы

02

Bianco  
White



# Scopini wc in resine termoplastiche

## G•CUCCILOLO

Design: Makio Hasuike

Thermoplastic resins toilet brushes - Porte-brosse en thermoplastique - WC-Bürstengarnituren aus Kunststoff  
Escobilleros en resinas termoplásticas - Ёршик из термопластичных смол



2033

ø 15 x 33,5 cm

Ciuffo in PVC o setole  
PVC or bristle brush  
Brosse en PVC ou nylon  
Bürste aus Nylon oder PVC  
Escobilla de nylon o PVC  
Щетка из нейлона или PVC

100%  
made in Italy



02  
Bianco  
White

**MoMA** June 27, 1977  
In permanent Design Collection  
of the Museum of Modern Art  
in New York

100%  
made in Italy



G•OSCAR

Design: Matteo Thun



8533-03

11 x 15 x 35 cm



Fissaggio  
con biadesivo  
o viti  
To be fixed with  
double-sided  
adhesive tape  
or screws



02

Bianco  
White

8833

ø 13 x 35 cm



02

Bianco  
White

P0

Rosa  
Pink

P1

Azzurro  
Light blue

P2

Bianco  
opalino  
Opaline white

P7

Acquamarina  
Aquamarine

COLORI LUCIDI - POLISHED COLOURS

NEW

NEW

NEW

22

Bianco  
lucido  
Polished  
White

08

Grigio  
Grey

66

Beige  
Beige

100%  
made in Italy

Novità - New

G•PETER

- 08 Grigio Grey
- 22 Bianco White
- 66 Beige Beige



6033

ø 14 x 41 cm

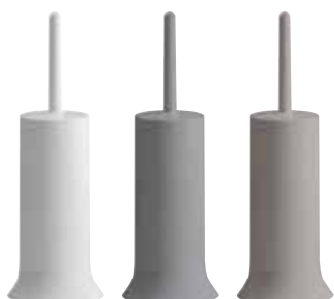

## 6334 G•SEVENTY

Design: Matteo Thun

9 X 9 X 38,8 cm



100%  
made in Italy

## 3133 G•MOBY

Design: Babled &amp; Co

11,1 x 10,9 x 37,8 cm



100%  
made in Italy

## 8034 G•JUNIOR

Design: Gianpiero Tonetti

ø 12,5 x 37,5 cm



100%  
made in Italy

## 8033 G•JUNIOR

ø 13,5 x 39 cm



100%  
made in Italy

## ZE33 G•ZENO

ø 12,2 x 37,6 cm



100%  
made in Italy

# Sedili wc

Toilet seats - Abattants - WC-Sitze - Asientos de inodoro - Туалетное сиденье



## 4026 G•CORNIOLA

37 x 47 x 7 cm



02

Bianco  
White

Realizzato in MDF con laccatura epossidica e cerniere in Cromall®

Made of epoxy lacquered M.D. with Cromall® hinges  
Réalisé en M.D. avec laquage époxy et fixations en Cromall®  
Hergestellt aus M.D. mit Epoxid-Beschichtung mit Scharnieren aus Cromall®  
Realizado en DM pintado epoxi y bisagras de Cromall®  
Туалетное сиденье из МДФ, покрытие эпоксидным лаком и петли из Cromall®

## 4007 G•SMERALDO

37,8 x 47 x 4 cm



02

Bianco  
White

Realizzato in MDF con laccatura epossidica e cerniere in ottone cromato

Made of epoxy lacquered M.D. with chromed brass hinges  
Réalisé en M.D. avec laquage époxy et fixations en laiton chromé  
Hergestellt aus M.D. mit Epoxid-Beschichtung mit Scharnieren aus verchromtem Messing  
Realizado en DM pintado epoxi y bisagras de latón cromado  
Туалетное сиденье из МДФ покрытие эпоксидным лаком и хромированные латунные петли

## 4029 G•ACQUAMARINA

35,6 x 48,5 x 3 cm



02

Bianco  
White

Realizzato in MDF e cerniere in Cromall®

Made of M.D. with Cromall® hinges  
Réalisé en M.D. et fixations en Cromall®  
Hergestellt aus M.D. mit Scharnieren aus Cromall®  
Realizado en DM y bisagras de Cromall®  
Туалетное сиденье из МДФ с петлями из Cromall®

Novità - New

## 4025 G•AGATA

36,8 x 45,4 x 5,4 cm



02

Bianco  
White

Realizzato in MDF con laccatura epossidica e cerniere in polipropilene

Made of epoxy lacquered M.D. with polypropylene hinges  
Réalisé en M.D. avec laquage époxy et fixations en polypropylène  
Hergestellt aus M.D. mit Epoxid-Beschichtung mit Scharnieren aus Polypropylen  
Realizado en DM pintado epoxi con bisagras de polipropileno  
Туалетное сиденье из МДФ, покрытие эпоксидным лаком и полипропиленовые петли

**Realizzato in MDF con laccatura epossidica e cerniere in ottone cromato**

Made of epoxy lacquered M.D with chromed brass hinges

Réalisé en M.D. avec laquage époxy et fixations en laiton chromé

Hergestellt aus M.D. mit Epoxid-Beschichtung mit Scharnieren aus verchromtem Messing

Realizado en DM pintado epoxi con bisagras de latón cromado

Изготовлено из МДФ, покрытие эпоксидным лаком и петли из хромированной латуни

**4005**

37,8 x 46,5 x 6 cm

**02**  
 Bianco  
 White

Sedile WC per sanitari modello disabili

Toilet seat for disabled model bathroom fittings

Abattant pour sanitaires modèle porteurs de handicap

WC-Sitz für Modell Behinderte

Asiento de inodoro para sanitarios para minusválidos

Сиденье для унитаза модели для инвалидов

**4009**

36,5 x 45,5 x 6 cm

**02**  
 Bianco  
 White

Sedile WC per sanitari modello disabili

Toilet seat for disabled model bathroom fittings

Abattant pour sanitaires modèle porteurs de handicap

WC-Sitz für Modell Behinderte

Asiento inodoro para sanitarios para minusválidos

Сиденье для унитаза модели для инвалидов

**4022**

34 x 46 x 5 cm

**02**  
 Bianco  
 White

16/20

Sedile WC per sanitari modello Conca

Toilet seat for Conca sanitary fixtures

Abattant pour sanitaires modèle Conca

WC-Sitz für Modell Conca

Asiento de inodoro para sanitarios modelo Conca

Сиденье для унитаза модели Conca

**4023**

34,8 x 42,5 x 6 cm

**02**  
 Bianco  
 White

12/15

Sedile WC per sanitari modello Tesi

Toilet seat for Tesi sanitary fixtures

Abattant pour sanitaires modèle Tesi

WC-Sitz für Modell Tesi

Asiento de inodoro para sanitarios modelo Tesi

Сиденье для унитаза модели Tesi



4014

35 x 46,5 x 5,9 cm



02

Bianco  
White

Sedile WC per sanitari modello Ellisse  
Toilet seat for Ellisse sanitary fixtures  
Abattant pour sanitaires modèle Ellisse  
WC-Sitz für Modell Ellisse  
Asiento de inodoro para sanitarios modelo Ellisse  
Сиденье для унитаза модели Ellisse

4024

36 x 47 x 5,5 cm



02

Bianco  
White

Sedile WC per sanitari modello Aretusa  
Toilet seat for Aretusa sanitary fixtures  
Abattant pour sanitaires modèle Aretusa  
WC-Sitz für Modell Aretusa  
Asiento de inodoro para sanitarios modelo Aretusa  
Сиденье для унитаза модели Aretusa

4027

35 x 48 x 5,8 cm



02

Bianco  
White

Sedile WC per sanitari modello Sintesi  
Toilet seat for Sintesi sanitary fixtures  
Abattant pour sanitaires modèle Sintesi  
WC-Sitz für Modell Sintesi  
Asiento de inodoro para sanitarios modelo Sintesi  
Сиденье для унитаза модели Sintesi

4028

36 x 41,5 x 6 cm



02

Bianco  
White

Sedile WC per sanitari modello Victoria  
Toilet seat for Victoria sanitary fixtures  
Abattant pour sanitaires modèle Victoria  
WC-Sitz für Modell Victoria  
Asiento de inodoro para sanitarios modelo Victoria  
Сиденье для унитаза модели Victoria

4030

34,4 x 44,7 x 6 cm



02

Bianco  
White

Sedile WC per sanitari modello System  
Toilet seat for System sanitary fixtures  
Abattant pour sanitaires modèle System  
WC-Sitz für Modell System  
Asiento de inodoro para sanitarios modelo System  
Сиденье для унитаза модели System

## CO41 G•GRANATO

37,5 x 45,6 x 5,5 cm



**Realizzato in MDF con laccatura epossidica e cerniere in ottone cromato**

Made of epoxy lacquered M.D. with chromed brass hinges

Réalisé en M.D. avec laquage époxy et fixations en laiton chromé

Hergestellt aus M.D. mit Epoxid-Beschichtung mit Scharnieren aus verchromtem Messing

Realizado en DM pintado epoxi y bisagras de latón cromado

Туалетное сиденье из МДФ покрытие эпоксидным лаком и хромированные латунные петли

Stampa  
**3D**  
Print



**02**  
Tigre



**04**  
Rana



**05**  
Tartaruga



**06**  
Pesce  
pagliaccio



**63**  
Fiori



**86**  
Pinguino



**92**  
Caraibi

## CO42 G•ONICE

37,5 x 44,5 x 6 cm



**Realizzato in MDF con laccatura epossidica e decoro metallico, dotato di cerniere in ottone cromato**

Made of epoxy lacquered M.D. with decorative metal plate, chromed brass hinges

Réalisé en M.D. avec laquage époxy et plaque de métal, fixations en laiton chromé

Hergestellt aus M.D. mit Epoxid-Beschichtung mit Metall-Dekor, mit Scharnieren aus verchromtem Messing

Realizado en DM pintado epoxi con placa metálica, bisagras de latón cromado

Изготовлено из МДФ с металлической пластиной, покрытие эпоксидным лаком и петли из хромированной латуни

Decoro  
**METALICO**  
Decorative  
**METAL  
PLATE**



**02**  
Open



**06**  
Gas

## 4001 G · AMETISTA

37,8 x 45,7 x 5 cm



02

Bianco  
White



**Realizzato in resine termoindurenti con cerniere in acciaio inox**

Made of thermosetting resins, hinges of stainless steel

Réalisé en thermodurcissable, fixations en acier inoxydable

Hergestellt aus Duroplast, Scharniere aus Edelstahl

Realizado en resinas termoestables con bisagras de acero inoxidable

Изготовлено из термореактивных пластмасс с петлями из нержавеющей стали

## 4031 G · MADREPERLA

36,3 x 45,6 x 3 cm



02

Bianco  
White

**Realizzato in polipropilene con cerniere in polipropilene**  
 Made of polypropylene with polypropylene hinges  
 Réalisé en polypropylène avec fixations en polypropylène  
 Hergestellt aus Polypropylen mit Scharnieren aus Polypropylen  
 Realizado en polipropileno con bisagras de polipropileno  
 Изготовлено из полипропилена, Полипропиленовые петли

Novità - New

## 4003 G · ZIRCONO

37,2 x 45,8 x 5,4 cm

02

02

Bianco  
White



**Realizzato in resine termoindurenti con cerniere in acciaio inox**

Made of thermosetting resins, hinges of stainless steel

Réalisé en thermodurcissable, fixations en acier inoxydable

Hergestellt aus Duroplast, Scharniere aus Edelstahl

Realizado en resinas termoestables con bisagras de acero inoxidable

Изготовлено из термореактивных пластмасс с петлями из нержавеющей стали

**4017 G•DIAMANTE**

37,3 x 45,7 x 5,7 cm

**02**Bianco  
White**Realizzato in resine termoindurenti, dotato di cerniere in resine termoplastiche**

Made of thermosetting resins with adjustable plastic hinges

Réalisé en thermodurcissable avec fixations réglables en thermoplastique

Hergestellt aus Duroplast mit Scharnieren aus Kunststoff

Realizado en resinas termoestables con bisagras de resinas termoestables

Изготовлено из термореактивных пластмасс.

Петли из термопластичных смол

**4019 G•OSCAR**

37 x 45,5 x 4 cm

**02**Bianco  
White100%  
made in Italy  
**Realizzato in resine termoplastiche con cerniere in polipropilene**

Made of thermoplastic resin with polypropylene hinges

Réalisé en thermoplastique avec fixations en polypropylène

Hergestellt aus Kunststoff mit Scharnieren aus Polypropylen

Realizado en resinas termoplásticas con bisagras de polipropileno

Изготовлено из термопластичных смол. Полипропиленовые петли

**4008 G•AMBRA**

37,5 x 46,5 x 3 cm

**02**Bianco  
White100%  
made in Italy  
**Realizzato in resine termoplastiche con cerniere in polipropilene**

Made of thermoplastic resin with polypropylene hinges

Réalisé en thermoplastique avec fixations en polypropylène

Hergestellt aus Kunststoff mit Scharnieren aus Polypropylen

Realizado en resinas termoplásticas con bisagras de polipropileno

Изготовлено из термопластичных смол. Полипропиленовые петли

# MULTIFUNCTION





# Piantane

# G•TOBIA

Towel stands  
Ensembles sur pied  
Handtuchständer  
Columns  
Стойка для полотенец

13

Cromato  
Chromed



7131

40,6 x 15,5 x 89 cm

7132

33 x 15,5 x 64 cm

**Realizzate in acciaio inox e resine termoplastiche**  
Made of stainless steel and thermoplastic resins  
Réalisés en acier inoxydable et thermoplastique  
Hergestellt aus Edelstahl und Kunststoff  
Realizadas en acero inox y resinas termoplásticas  
Изготовлено из нержавеющей стали и термопластичных смол







7831

39 x 16 x 89 cm

7832

25 x 16 x 70 cm

**Realizzate in acciaio inox, Cromall® e resine termoplastiche**

Made of stainless steel, Cromall® and thermoplastic resins

Réalisés en acier inoxydable, Cromall® et thermoplastique

Hergestellt aus Edelstahl, Cromall® und Kunststoff

Realizadas en acero inox, Cromall® y resinas termoplásticas

Изготовлено из нержавеющей стали, Cromall® и термопластичных смол





2131

ø 21 x 42 x 88 cm

2132

ø 21 x 26 x 61 cm

**Realizzate in acciaio inox e resine termoplastiche**

Made of stainless steel and thermoplastic resins

Réalisés en acier inoxydable et thermoplastique

Hergestellt aus Edelstahl und Kunststoff

Realizadas en acero inox y resinas termoplásticas

Изготовлено из нержавеющей стали и термопластичных смол



## G•RAINBOW

## COLORI TRASPARENTI - TRASPARENT COLOURS

02	04	05	06	14	52	66	67	73	79
Bianco White	Verde acido Acid green	Blu Blue	Rosso Red	Nero Black	Tortora Turtledove grey	Tortora chiaro Light turtledove grey	Arancio Orange	Argento Silver	Lilla Lilac

## COLORI PIENI - SOLID COLOURS

08	22	01	12
Grigio Grey	Bianco White	Tortora Turtledove grey	Tortora chiaro Light turtledove grey



## RA31

40,4 x 15,5 x 83,7 cm

## RA32

25,7 x 16 x 58,8 cm

**Realizzate in acciaio inox e resine termoplastiche**

Made of stainless steel and thermoplastic resins

Réalisés en acier inoxydable et thermoplastique

Hergestellt aus Edelstahl und Kunststoff

Realizadas en acero inox y resinas termoplásticas

Изготовлено из нержавеющей стали и термопластичных смол





2731

ø 25 x 43,5 x 93,7 cm

2732

ø 25 x 25,5 x 78,5 cm

**Realizzate in metallo con contenitori in vetro satinato**

Made of metal with frosted glass containers

Réalisés en métal avec boîtiers en verre satiné

Hergestellt aus Metall mit Behältern aus satiniertem Glas

Realizadas en metal con contenedores en cristal satinado

Изготовлено из металла с ёмкостями из матового стекла





# G•WINNY

Design: Piet Billekens

02

Bianco  
White

13

Cromato  
Chromed



2831

ø 25 x 43,6 x 89 cm

2832

ø 25 x 29 x 67 cm

**Realizzate in acciaio inox**

Made of stainless steel

Réalisés en acier inoxydable

Hergestellt aus Edelstahl

Realizadas en acero inox

Изготовлено из нержавеющей сталь



13

Cromato  
Chromed

03

Beige  
Beige

TR31

34 x 14 x 83,3 cm

TR32

14 x 14 x 62,8 cm

**03** Realizzate in acciaio inox, Cromall®, resina, sabbia e resina termoplastica  
 Made of stainless steel, Cromall®, resin, sand and thermoplastic resins  
 Réalisés en acier inoxydable, Cromall®, résine, sable et thermoplastique  
 Hergestellt aus Edelstahl, Cromall®, Harz, Sand und Kunststoff  
 Realizadas en acero inox, Cromall®, resina, arena y resinas termoplásticas  
 Изготовлено из нержавеющей стали, Cromall®, смол, песка и термопластичных смол

**13** Realizzate in acciaio inox, Cromall® e resina termoplastica

Made of stainless steel, Cromall® and thermoplastic resins  
 Réalisés en acier inoxydable, Cromall® et thermoplastique  
 Hergestellt aus Edelstahl, Cromall® und Kunststoff  
 Realizadas en acero inox, Cromall® y resinas termoplásticas  
 Изготовлено из нержавеющей стали, Cromall® и термопластичных смол





## G•HIBISCUS

13

Cromato  
Chromed

HI31

36,5 x 30 x 90,5 cm

HI32

29,6 x 18 x 75 cm

Realizzate in metallo  
 Made of metal  
 Réalisés en métal  
 Hergestellt aus Metall  
 Realizadas en metal  
 Изготовлено из металла



100%  
made in Italy



G•MAMMOLO

02

Bianco  
White



MM31

24,5 x 43 x 89,5 cm

MM32

20 x 20 x 78,5 cm

**Realizzate in alluminio, acciaio inox e resine termoplastiche**

Made of aluminum, stainless steel and thermoplastic resins

Réalisés en aluminium, acier inoxydable et thermoplastique

Hergestellt aus Aluminium, Edelstahl und Kunststoff

Realizadas en aluminio, acero inox y resinas termoplásticas

Изготовлено из алюминий, нержавеющей стали и термопластичных смол



Novità - New

G•MINU'

**Piantana portarotolo di riserva**

Freestanding spare toilet paper holder  
 Support de papier WC sur pied  
 Ständer Ersatzrollenhalterung  
 Soporte portarrollos de reserva  
 Держатель запасного рулона

13

Cromato  
 Chromed

**MU37**

14,2 x 23 x 61 cm

**Realizzate in metallo**  
 Made of metal  
 Réalisés en métal  
 Hergestellt aus Metall  
 Realizado en metal  
 Изготовлено из металла



# G•WENDY

Design: Babled e Co.

<b>02</b>	<b>48</b>	<b>58</b>	<b>71</b>	<b>39</b>
Bianco White	Bianco/ tortora White/ turtledove grey	Bianco/ tortora chiaro White/light turtledove grey	Bianco/ grigio White/ grey	Bianco/ blu White/ blue



**7032**

20,4 x 16 x 69,8 cm

**Realizzata in resine termoplastiche**  
 Made of thermoplastic resins  
 Réalisée en thermoplastique  
 Hergestellt aus Kunststoff  
 Realizado en resinas termoplásticas  
 Изготовлено из термопластичных смол





**1031**

50 x 4 x 190 cm

**Realizzata in bambù**  
Made of bamboo  
Réalisée en bambou  
Hergestellt aus Bambus  
Realizada en bambú  
Изготовлено из бамбука



# Appendiabiti

Hooks - Crochets - Haken - Perchas - Крючки

## 2128

20 x 3,1 x 4 cm



**Cromall®/ottone**  
Cromall®/brass  
Cromall®/laiton  
Cromall®/Messing  
Cromall®/latón  
Cromall®/латунь

**13**  
Cromato  
Chromed

## 2123

40 x 7,2 x 12,2 cm

**Sopraporta**  
Over door



**Acciaio inox**  
Stainless steel  
Acier inoxydable  
Edelstahl  
Acero inox  
нержавеющей стали

**13**  
Lucido  
Polished

## 2124

40 x 5,4 x 13,6 cm

**Sopraporta**  
Over door

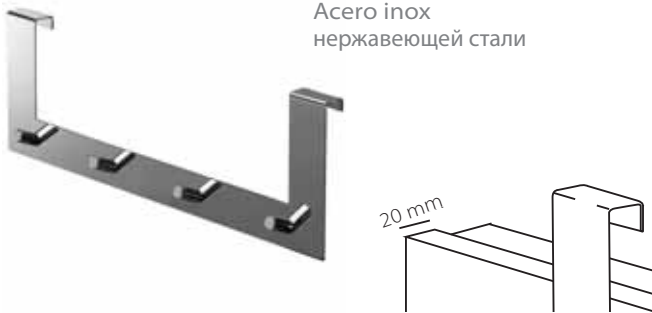

**Acciaio inox**  
Stainless steel  
Acier inoxydable  
Edelstahl  
Acero inox  
нержавеющей стали

**13**  
Lucido  
Polished

## 4226 G•VERMONT

7,5 x 5 x 6 cm



**Cromall®**

**13**  
Cromato  
Chromed

Fissabile anche con colla (venduta a parte)  
Can be fixed with glue (sold separately)  
Peut être fixé avec colle (vendu séparément)  
Kann mit Kleber fixiert werden (separat erhältlich)  
Se puede fijar con pegamento (se vende por separado)  
Может быть закреплён клеем (продается отдельно)

## 2127

ø 1,8 x 3 cm

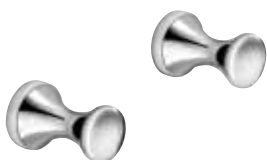

**Ottone**  
Brass  
Laiton  
Messing  
Latón  
латунь

**13**  
Cromato  
Chromed

## 6928 G•COLORADO

6,5 x 6 x 4 cm



**Cromall®**

**13**  
Cromato  
Chromed

Fissabile anche con colla (venduta a parte)  
Can be fixed with glue (sold separately)  
Peut être fixé avec colle (vendu séparément)  
Kann mit Kleber fixiert werden (separat erhältlich)  
Se puede fijar con pegamento (se vende por separado)  
Может быть закреплён клеем (продается отдельно)

## 6926 G•COLORADO

4 x 5 x 4 cm



**Cromall®**

**13**  
Cromato  
Chromed

Fissabile anche con colla (venduta a parte)  
Can be fixed with glue (sold separately)  
Peut être fixé avec colle (vendu séparément)  
Kann mit Kleber fixiert werden (separat erhältlich)  
Se puede fijar con pegamento (se vende por separado)  
Может быть закреплён клеем (продается отдельно)



**2125**

4,5 x 7,5 x 14 cm

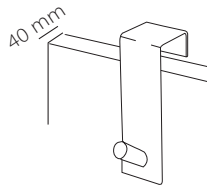
**Sopraporta**  
Over door**Acciaio inox**  
Stainless steel  
Acier inoxydable  
Edelstahl  
Acero inox  
нержавеющей стали**13**Lucido  
Polished**2126**

3 x 4,6 x 11 cm

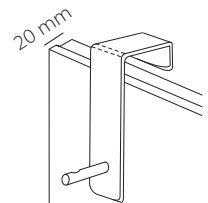
**Sopraporta**  
Over door**Acciaio inox**  
Stainless steel  
Acier inoxydable  
Edelstahl  
Acero inox  
нержавеющей стали**13**Lucido  
Polished**HO26 G•HOT**

6,3x 4,5 x 10,8 cm

**Metallo/resine termoplastiche**  
Metal/thermoplastic resins  
Métal/thermoplastique  
Metall/Kunststoff  
Metal/resinas termoplásticas  
металл/термопластичные смолы**13**Cromato  
ChromedFissaggio con ventosa - Suction cup fixing  
Fixation avec ventouses  
Befestigung mit Saugnapfen  
Fijación con ventosas  
Крепление при помощи присосок**6027****Design:**  
Ambrogio Rossari

4,9 x 4,2 x 10,5 cm

**Resine termoplastiche**  
Thermoplastic resins  
Thermoplastique  
Kunststoff  
Resinas termoplásticas  
Термопластичные смолы**02**Bianco  
White**100%**  
made in Italy**VS26 G•VESUVIO**

11,3 x 3 x 11 cm

**VS28 G•VESUVIO**

5,5 x 3 x 11 cm

**Resine termoplastiche**  
Thermoplastic resins  
Thermoplastique  
Kunststoff  
Resinas termoplásticas  
Термопластичные смолы**02**Bianco  
WhiteFissaggio con ventosa - Suction cup fixing  
Fixation avec ventouses  
Befestigung mit Saugnapfen  
Fijación con ventosas  
Крепление при помощи присосок

# Appendiabiti doppio

# G•RAINBOW

Double hook  
Crochet double  
Haken doppelt  
Percha doble  
Двойная вешалка



## RA26

8 x 3,1 x 4 cm

### Realizzati in resine termoplastiche

Made of thermoplastic resins

Réalisés en thermoplastique

Hergestellt aus Kunststoff

Realizadas en resinas termoplásticas

Изготовлено из термопластичных смол



Fissaggio con biadesivo

To be fixed with double - sided adhesive

Fixation avec adhésif double face

Befestigung mit doppelseitigem Klebeband

Fijación con adhesivo de dos caras

Крепление при помощи двухсторонней

клеякой ленты



COLORI PIENI - SOLID COLOURS

- 01** Tortora Turtledove grey
- 08** Grigio Grey
- 12** Tortora chiaro Light turtledove grey
- 22** Bianco White

COLORI TRASPARENTI - TRASPARENT COLOURS

- 02** Bianco White
- 04** Verde acido Acid green
- 05** Blu Blue
- 06** Rosso Red
- 14** Nero Black
- 52** Tortora Turtledove grey
- 66** Tortora chiaro Turtledove grey
- 67** Arancio Orange
- 73** Argento Silver
- 79** Lilla Lilac



# Appendiabiti singolo

## G•RAINBOW

Hook  
Crochet  
Haken  
Percha  
Одинарный крючок



### RA27

4,3 x 3,4 x 6,5 cm

#### Realizzati in resine termoplastiche

Made of thermoplastic resins

Réalisés en thermoplastique

Hergestellt aus Kunststoff

Realizadas en resinas termoplásticas

Изготовлено из термопластичных смол



Fissaggio con biadesivo

To be fixed with double - sided adhesive

Fixation avec adhésif double face

Befestigung mit doppelseitigem Klebeband

Fijación con adhesivo de dos caras

Крепление при помощи двухсторонней

клеякой ленты



COLORI PIENI - SOLID COLOURS

- 01

Tortora  
Turtledove  
grey
- 08

Grigio  
Grey
- 12

Tortora  
chiaro  
Light  
turtledove  
grey
- 22

Bianco  
White

COLORI TRASPARENTI - TRASPARENT COLOURS

- 02

Bianco  
White
- 04

Verde acido  
Acid green
- 05

Blu  
Blue
- 06

Rosso  
Red
- 14

Nero  
Black
- 52

Tortora  
Turtledove  
grey
- 66

Tortora  
chiaro  
Light  
turtledove  
grey
- 67

Arancio  
Orange
- 73

Argento  
Silver
- 79

Lilla  
Lilac





# Appendiabiti per termoarredi

G•MERLINO

Hanging hook for designer radiators  
Crochets décoratifs pour radiateurs  
Kleiderhaken für Heizkörper  
Percha para toalleros radiadores decorativos  
Вешалка на батарею



2025

3,2 x 6,7 x 11,7 cm

**Realizzati in resine termoplastiche**

Made of thermoplastic resins

Réalisés en thermoplastique

Hergestellt aus Kunststoff

Realizadas en resinas termoplásticas

Изготовлено из термопластичных смол



COLORI TRASPARENTI - TRANSPARENT COLOURS

- 00

Trasparente  
Transparent
- 13

Cromato  
Chromed
- 29

Moka  
Moka
- 85

Antracite  
Anthracitey
- P0

Fucsia  
Fuchsia
- P1

Azzurro  
Light blue
- P4

Arancio  
Orange
- P8

Verde  
Green
- P9

Lilla  
Lilac

COLORI PIENI - SOLID COLOURS

- 02

Bianco  
White
- 08

Grigio  
Grey
- 14

Nero  
Black
- 52

Tortora  
Turtledove  
grey
- 66

Tortora chiaro  
Light  
turtledove  
grey



# Porta asciugacapelli

Hairdryer supports  
 Supports sèche-cheveux  
 Haartrocknerhalter  
 Soportes para secador de pelo  
 Держатель для фена

13

Cromato  
 Chromed



## 5055

10,6 x 16 x 17 cm

**Acciaio inox e Cromall®**  
 Stainless steel and Cromall®  
 Acier inoxydable et Cromall®  
 Edelstahl und Cromall®  
 Acero inox y Cromall®  
 Нержавеющей стали и Cromall®



Fissaggio ad INCOLLO  
 Fixes into place with adhesive  
 Fixation par encollage  
 Befestigung mit Klebstoff  
 Fijación mediante pegado  
 Крепление клеем



Fissaggio con VITI  
 Fixes into place with screws  
 Fixation par vis  
 Befestigung mit Schrauben  
 Fijación con tornillos  
 Крепление шурупами



## 5056

10,6 x 16,3 x 18,2 cm



**Acciaio inox e Cromall®**  
 Stainless steel and Cromall®  
 Acier inoxydable et Cromall®  
 Edelstahl und Cromall®  
 Acero inox y Cromall®  
 Нержавеющей стали и Cromall®

13

Cromato  
 lucido  
 Chromed



Fissaggio ad INCOLLO  
 Fixes into place with adhesive  
 Fixation par encollage  
 Befestigung mit Klebstoff  
 Fijación mediante pegado  
 Крепление клеем



Fissaggio con VITI  
 Fixes into place with screws  
 Fixation par vis  
 Befestigung mit Schrauben  
 Fijación con tornillos  
 Крепление шурупами

## HO52 G•HOT

10,7 x 12 x 22 cm



**Metallo e resine termoplastiche**  
 Metal and thermoplastic resins  
 Métal et thermoplastique  
 Metall und Kunststoff  
 Metal y resinas termoplásticas  
 металл и термопластичные смолы

13

Cromato  
 lucido  
 Chromed



Fissaggio con ventosa - Suction cup fixing  
 Fixation avec ventouses  
 Befestigung mit Saugnäpfen  
 Fijación con ventosas  
 Крепление при помощи присосок



## 5052/301

9,5 x 10,2 x 11,2 cm



**Resine termoplastiche**  
 Thermoplastic resins  
 Thermoplastique  
 Kunststoff  
 Resinas termoplásticas  
 термопластичные смолы

100%  
 made in Italy

02

Bianco  
 White



Fissaggio ad INCOLLO  
 Fixes into place with adhesive  
 Fixation par encollage  
 Befestigung mit Klebstoff  
 Fijación mediante pegado  
 Крепление клеем

**TE55**

10 x 14 x 7,3 cm

**Acciaio inox e Cromall®**  
 Stainless steel and Cromall®  
 Acier inoxydable et Cromall®  
 Edelstahl und Cromall®  
 Acero inox y Cromall®  
 Нержавеющей стали и Cromall®



Fissaggio con biadesivo  
 To be fixed with double  
 sided sticky tape  
 Fixation avec adhésif double face  
 Befestigung mit doppelseitigem Klebeband  
 Fijación con adhesivo de dos caras  
 Крепление при помощи двухсторонней  
 клейкой ленты

# Sgabelli

Stools  
Tabourets  
Hocker  
Taburetes  
Табу­ре­ты



**6072**

40,9 x 33,1 x 43,8 cm

Design: Studio Talocci

Alluminio/ABS  
Aluminium/ABS  
Aluminium/ABS  
Aluminio/ABS  
Алюминий/АБС-пластик



100%  
made in Italy



Bianco/  
White



Bianco/  
cromato  
White/  
chromed



Antracite/  
cromato  
Anthracite/  
chromed



**2872 G•TETRA**

Design: Olaf Von Bohr

42 x 27 x 41 cm



Resine termoplastiche  
 Thermoplastic resins  
 Thermoplastique  
 Kunststoff  
 Resinas termoplásticas  
 термопластичные смолы

100%  
 made in Italy

**02**Bianco  
White**2072 G•TRIO**

ø 33 x 40 cm



Resine termoplastiche  
 Thermoplastic resins  
 Thermoplastique  
 Kunststoff  
 Resinas termoplásticas  
 термопластичные смолы

100%  
 made in Italy

**02**Bianco  
White



# Sgabello e cesto svuota lavatrice

Stool and laundry basket  
 Tabouret et coffre à linge  
 Hocker und Wäschebehälter  
 Taburete y cesto para ropa  
 Табурет и корзина для белья



## 7073 G•WENDY

35,6 x 32,6 x 38,9 cm

120  
kg

Design: Babled & Co.

**Realizzato in resine termoplastiche**

Thermoplastic resins

Réalisé en thermoplastique

Hergestellt aus Kunststoff

Realizado en resinas termoplásticas

Изготовлено из термопластичных смол

BELLO RESISTENTE FLESSIBILE  
 AGILE COLORATO IMPILABILE  
 EYE-CATCHING DURABLE FLEXIBLE  
 NIMBLE COLORFUL STACKABLE

Il primo SGABELLO-CESTO che puoi usare come ti GIRA!  
 The first STOOL-BASKET to turn your world upside down!



# Sgabelli richiudibili

Foldable stools  
Tabourets repliables  
Klapphocker  
Taburetes plegable  
Складные табуреты

## C073

ø 29,8 x 46 cm



**Realizzato in MDF e metallo**  
MDF and steel  
Réalisé en MDF et métal  
Hergestellt aus MDF und Metall  
Realizado en DM y metal  
Изготовлено из MDF и металла



98

Pero  
Pear wood

## C075

30 x 29,3 x 46,5 cm



**Realizzato in resine termoplastiche e metallo**  
Thermoplastic resins and steel  
Réalisé en thermoplastique et métal  
Hergestellt aus Kunststoff und Metall  
Realizado en resinas termoplásticas y metal  
Изготовлено из термопластичных смол  
и металла



02

Bianco  
White

05

Blu  
Blue

67

Arancio  
Arancio

76

Fucsia  
Fuchsia

79

Lilla  
Lilac

<b>02</b>	<b>08</b>	<b>52</b>	<b>66</b>
Bianco White	Grigio Grey	Tortora Turtledove grey	Tortora chiaro Light turtledove grey



## CO76

26 x 28 x 46,5 cm

**Realizzato in resine termoplastiche e metallo**

Made of thermoplastic resins and steel

Réalisé en thermoplastique et métal

Hergestellt aus Kunststoff und Metall

Realizado en resinas termoplásticas y metal

Изготовлено из термопластичных смол и металла

100  
kg



# Cesti portabiancheria e scatole

# G•AMBROGIO

02

Bianco  
White

03

Beige

05

Blu  
Blue

Laundry baskets and boxes - Panier à linge et boîtes - Wäschebehälter und Boxen  
Cestos contenedoras para ropa sucia y cajas - Корзина для грязного белья и коробки



2038

50 x 28 x 55 cm

Realizzato in resine termoplastiche  
Made of thermoplastic resins  
Réalisé en thermoplastique  
Hergestellt aus Kunststoff  
Realizado en resinas termoplásticas  
Изготовлено из термопластичных смол





Novità - New

G•TATAMI

02

Bianco  
White

14

Nero  
Black



## TA38

35,5 x 35,5 x 63 cm

**Realizzato in bambù**  
Made of bamboo  
Réalisé en bambou  
Hergestellt aus Bambus  
Realizado en bambú  
Изготовлено из бамбука

**Sacchetto interno estraibile e lavabile per la massima igiene**  
Fully removable and washable sack inside for maximum hygiene  
Sachet intérieur extractible et lavable pour le maximum d'hygiène  
Wäschebeutel, Innenteil abnehmbar und waschbar für maximale Hygiene  
Bolsita interna extraíble y lavable para la máxima higiene  
В целях гигиены внутренний пакет можно извлечь и помыть





## BY38

34 x 15 x 60 cm

**Realizzato in tessuto (cotone 70%, poliestere 30%)**  
 Made of fabric (cotton 70%, polyester 30%)  
 Réalisé en tissu (coton 70%, polyester 30%)  
 Hergestellt aus Stoff (Baumwolle 70%, Polyester 30%)  
 Realizado en tela (algodón 70%, poliéster 30%)  
 Изготовлено из ткани (хлопок 70%, полиэстер 30%)



03

Ecrù  
Ecrù



## CO38 G•LAUNDRY

ø 38 x 58 cm

**Realizzato in tessuto (cotone 35%, poliestere 65%) e metallo**

Fabric (cotton 35%, polyester 65%) and metal

Réalisé en tissu (coton 35%, polyester 65%) et métal

Hergestellt aus Stoff (Baumwolle 35%, Polyester 65%) und Metall

Realizado en tela (algodón 35%, poliéster 65%) y metal

Изготовлено из ткани (хлопок 35%, полиэстер 65%) и металла

03

Ecrú

11

Azzurro  
Light blue

## G•LAVANDA



LA38

35 x 35 x 58 cm

**Realizzati in rafia e nylon**

Made of raffia and nylon - Réalisés en raphia et nylon - Hergestellt aus Bast und Nylon Realizados en rafia y nylon - Изготовлено из рафии и нейлона

08

Grigio  
Grey

29

Moka



LA99 set 4 pz./pcs

2 da cm. 11x10x7,5

1 da cm. 13,5x24x8

1 da cm. 15,5x25,5x9



LA06

31 x 19 x 16,5 cm



LA07

21 x 15 x 12 cm

## RA00 G•RAINBOW

19 x 11 x 7,5 cm

**Realizzato in resine termoplastiche**

Made of thermoplastic resins

Réalisé en thermoplastique

Hergestellt aus Kunststoff

Realizado en resinas termoplásticas

Изготовлено из термопластичных смол

02

Bianco  
trasparente  
Transparent  
white

04

Verde acido  
trasparente  
Transparent  
acid green

05

Blu  
trasparente  
Transparent  
blue

06

Rosso  
trasparente  
Transparent  
red

14

Nero  
trasparente  
Transparent  
black

67

Arancio  
trasparente  
Transparent  
orange

73

Argento  
trasparente  
Transparent  
silver

79

Lilla  
trasparente  
Transparent  
lilac

52

Tortora  
trasparente  
Transparent  
turtledove  
grey

66

Tortora chiaro  
trasparente  
Transparent  
light  
turtledove  
grey

## GLOO G•GLADY

18,5 x 10,5 x 7,5 cm

**Realizzato in resine termoplastiche**

Made of thermoplastic resins

Réalisé en thermoplastique

Hergestellt aus Kunststoff

Realizado en resinas termoplásticas

Изготовлено из термопластичных смол

00

Trasparente  
Transparent

# Mensole

Shelves - Étagères - Ablagen - Estantes - Полочки

**Realizzate in vetro Ultralight 6 mm e Cromall®**

Made of 6 mm Ultralight glass and Cromall®

Réalisés en verre Ultralight 6 mm et Cromall®

Hergestellt aus 6 mm Ultralight Glas und Cromall®

Realizados en cristal Ultralight 6 mm y Cromall®

Изготовлено из стекла Ultralight 6 mm и Cromall®

100% **G•ARTEMIS**  
made in Italy

**2119/24**

24 x 24 x 2 cm



**2119/30**

30 x 16,5 x 2 cm

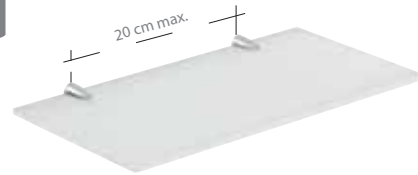

**2119/45**

45 x 16,5 x 2 cm



**2119/60**

60 x 16,5 x 2 cm

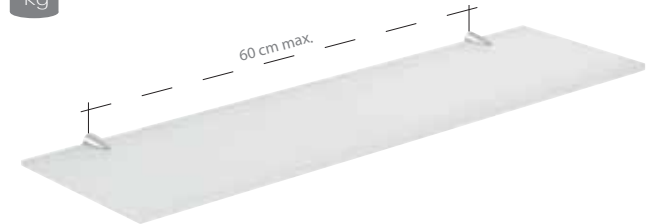

100%  
made in Italy

**G•SPOT**



Fucsia  
Fuxia



Azzurro  
Light blue



Trasparente  
Transparent



Arancio  
Orange



Verde acido  
Acid green



Lilla  
Lilac

**NEW NEW NEW**



Bianco  
White



Grigio  
Grey



Tortora  
chiaro  
Light  
turtledove  
grey

**2004**

12,7 x 8,7 x 1,6 cm



**Portasapone**

Soap holder - Porte savon

Seifenschale - Jabonera - мьльница

**Realizzato in PVC**

Made of PVC - Réalisé en PVC - Hergestellt aus PVC

Realizada en PVC - Изготовлено из ПВХ

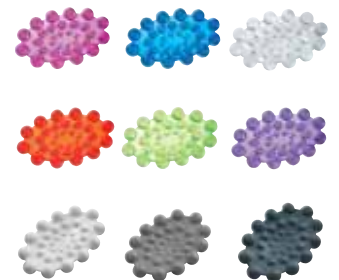

WATER



# Angolari e porta oggetti

# G•CLOUD

38

Spazzolato  
Brushed

Corner shelves - Étagère d'angle  
Eckablagen - Estantes angulares  
Угловая мыльница в душ

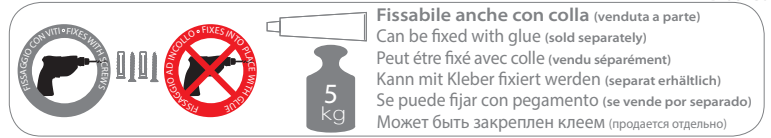
**CD18**

30 x 14,6 x 5,8 cm

**CD82**

30 x 14,6 x 30 cm

**Alluminio anodizzato, vetro temperato**

Anodised aluminium, tempered glass

Aluminium anodisé, verre tempéré

Eloxiertes Aluminium, Sekuritglas

Aluminio anodizado, cristal templado

Анодированный алюминий, закаленного стекла





**Fissabile anche con colla** (venduta a parte)  
 Can be fixed with glue (sold separately)  
 Peut être fixé avec colle (vendu séparément)  
 Kann mit Kleber fixiert werden (separat erhältlich)  
 Se puede fijar con pegamento (se vende por separado)  
 Может быть закреплен клеем (продается отдельно)



CD80

26 x 26 x 5,8 cm



CD81

26 x 26 x 30 cm





Realizzati in acciaio inox

Made of stainless steel- Réalisés en acier inoxydable

Hergestellt aus Edelstahl - Realizados en acero inox

Изготовлено из нержавеющей стали

**2484**

17,2 x 17,2 x 61,5 cm



13

Cromato  
Chromed

**2482**

20 x 15,1 x 32,5 cm



13

Cromato  
Chromed

**2481**

20 x 15 x 27 cm



13

Cromato  
Chromed

**2418**

Design: Carlo Vietri

25 x 9,6 x 3,5 cm

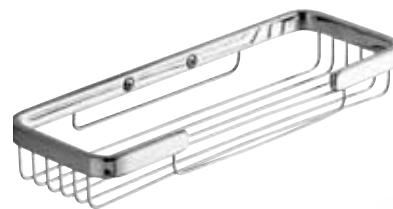

13

Cromato  
Chromed

**2481**

20 x 15 x 27 cm



13

Cromato  
Chromed

**2480**

Design: Carlo Vietri

19,3 x 19,3 x 3,5 cm



13

Cromato  
Chromed



2411

Design: Carlo Vietri

12,5 x 10 x 3,5 cm



2405

6 x 1,7 x 3,8 cm

**Kit 2 placche ad incollo**

Pack of 2 plates with glue system - Kit 2 plaques à coller  
 Packung mit 2 Wandplatten mit Klebefestigung  
 Caja de 2 placas de pared con fijación con pegamento  
 Набор из 2 клеящихся пластин в комплекте с клеем

**Cromall®****UTILIZZABILI CON I SEGUENTI ANGOLARI**

Can be mounted with - Peut être monté avec - Montierbar mit  
 Pueden montarse con - Может устанавливаться с:  
 2418 - 2419 - 2480 - 2481 - 2482 - 2483 - 2484

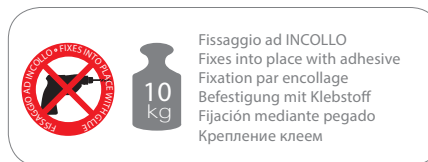
**Realizzati in metallo e resine termoplastiche**

Made of metal and thermoplastic resins - Réalisés en métal et thermoplastique  
 Hergestellt aus Metall und Kunststoff - Realizados en metal y resinas termoplásticas  
 Изготовлено из металла и термопластичных смол

HO20 G•HOT

27,5 x 13,6 x 12 cm



HO80 G•HOT

19 x 19 x 10 cm



SOLO SU SUPERFICI LISCE (SPECCHI, PIASTRELLE)  
 FOR FLAT SURFACES (MIRRORS, TILES) ONLY

Fissaggio con ventosa - Suction cup fixing  
 Fixation avec ventouses - Befestigung mit Saugnäpfen  
 Fijación con ventosas  
 Крепление при помощи присосок

13

Cromato  
Chromed

2485

24 x 22 x 49 cm



2486

24 x 22 x 68 cm



**Realizzato in metallo**  
 Made of chromed steel  
 Réalisé en métal chromé  
 Hergestellt aus verchromtem Metall  
 Realizado en metal cromado  
 Изготовлено из хромированного металла

## G•TITO

13

Cromato  
Chromed**2487**

24 x 22 x 49 cm

**2488**

24 x 22 x 68 cm



13

Cromato  
Chromed

14

Nero matt  
Matt black

2419

25,2x10,2x8,6 cm

2483

20x15,1x8 cm

Realizzati in acciaio inox  
 Made of stainless steel  
 Réalisée en acier inoxydable  
 Hergestellt aus Edelstahl  
 Realizada en acero inox  
 Изготовлено из нержавеющей сталь

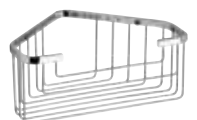





2417

30x12,8x4,5 cm

2479

21x21x4,5 cm

Realizzati in acciaio inox AISI 304

Made of stainless steel AISI 304

Réalisée en acier inoxydable AISI 304

Hergestellt aus Edelstahl AISI 304

Realizada en acero inox AISI 304

Изготовлено из нержавеющей сталь AISI 304



## G•TIBERIO

Design: Leo De Carlo



**Fissabile anche con colla** (venduta a parte)  
 Can be fixed with glue (sold separately)  
 Peut être fixé avec colle (vendu séparément)  
 Kann mit Kleber fixiert werden (separat erhältlich)  
 Se puede fijar con pegamento (se vende por separado)  
 Может быть закреплён клеем (продается отдельно)



13

Cromato  
Chromed

2416

24 x 12,5 x 6,5 cm



2478

19 x 19 x 6,5 cm



**Realizzati in resine termoplastiche**  
 Made of thermoplastic resins  
 Réalisée en thermoplastique  
 Hergestellt aus Kunststoff  
 Realizada en resinas termoplásticas  
 Изготовлено из термопластиченых смол



100%  
made in Italy



# G•CAESAR

02

Bianco  
White

NEW  
52

Tortora  
Turtledove  
grey

NEW  
08

Grigio  
Grey



**7080**

22,6 x 16 x 47,3 cm

**7081**

22,6 x 16 x 71 cm

**Realizzate in resine termoplastiche e acciaio inox**

Made of thermoplastic resins and stainless steel

Réalisés en thermoplastique et acier inoxydable

Hergestellt aus Kunststoff und Edelstahl

Realizadas en resinas termoplásticas y acero inox

Изготовлено из термопластичных смол и нержавеющей стали



**Realizzati in resine termoplastiche**

Made of thermoplastic resins

Réalisée en thermoplastique

Hergestellt aus Kunststoff

Realizada en resinas termoplásticas

Изготовлено из термопластиченых смол

**8081 G•JUNIOR**

22 x 12 x 47 cm

**02**Bianco  
White100%  
made in Italy**8079 G•JUNIOR**

22 x 14 x 38 cm

**02**Bianco  
White100%  
made in Italy**8080 G•JUNIOR**

Design: Gianpietro Tonetti

19,6 x 15,6 x 3 cm

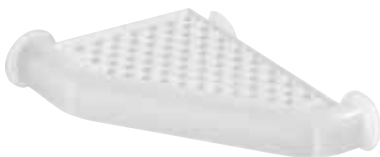
**02**Bianco  
White100%  
made in Italy

Fissaggio con VITI o VENTOSE  
To be fixed with suction cups or screws  
Fixation avec ventouses ou vis  
Befestigung mit  
Saugnapf oder Schrauben  
Fijación con ventosas o tornillos  
Крепление при помощи присосок или шурупов

## G•OSCAR



**Fissabile anche con silicone e biadesivo** (non incluso)

Can be fixed with silicon and sided sticky tape (not included)

Peut être fixé avec du silicone et de l'adhésif double face (vendu séparément)

Kann mit Silikon und doppelseitigem Klebeband fixiert werden (separat erhältlich)

Se puede fijar con silicona y adhesivo de dos caras (se vende por separado)

Может быть закреплен силиконом или использованием двухсторонней клейкой ленты (продается отдельно)

4 kg

02

Bianco  
White

52

Tortora  
Turtledove  
grey

08

Grigio  
Grey



8579

23 x 23 x 37,3 cm

**Realizzati in resine termoplastiche**

Made of thermoplastic resins

Réalisée en thermoplastique

Hergestellt aus Kunststoff

Realizada en resinas termoplásticas

Изготовлено из термопластиченых смол



100%  
made in Italy

# Tergivetro

Novità - New

# G•GUMMY

Wiper-blade  
Raclette de douche  
Glasabzieher  
Limpiacristales  
Стеклоочиститель

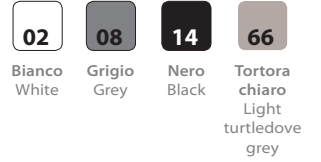

2641

22 x 3 x 23 cm

**Realizzati in resine termoplastiche**  
Made of thermoplastic resins  
Réalisée en thermoplastique  
Hergestellt aus Kunststoff  
Realizada en resinas termoplásticas  
Изготовлено из термопластиченых смол





# Tappeti antiscivolo

Non slip mats  
Tapis anti antidérapants  
Rutsch sichere Matten  
Alfombras antideslizantes  
Антискользящие коврики



Realizzati in PVC  
Made of PVC  
Réalisés en PVC  
Hergestellt aus PVC  
Realizadas en PVC  
Изготовлено из ПВХ

100%  
made in Italy

**975858**

**976060**

60 x 60 x 0,6 cm

60 x 60 x 0,6 cm

PER DOCCIA  
FOR SHOWER

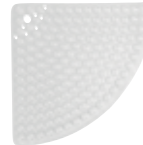

**978060**

**971040**

80 x 60 x 0,6 cm

104 x 40 x 0,6 cm



**00**

PER VASCA  
FOR BATHTUB



Trasparente  
Transparent



Realizzati in PVC  
Made of PVC  
Réalisés en PVC  
Hergestellt aus PVC  
Realizadas en PVC  
Изготовлено из PVC

100%  
made in Italy

**975151 - G•MARGHERITA**

51,5 x 51,5 cm

PER DOCCIA  
FOR SHOWER

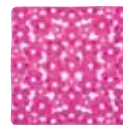

**973572 - G•MARGHERITA**

72 x 34,5 cm

PER VASCA  
FOR BATHTUB



**P0**

**P1**

**P2**

**P4**

**P8**

**P9**

Fucsia  
Fuchsia

Azzurro  
Light blue

Trasparente  
Transparent

Arancio  
Orange

Verde  
Green

Lilla  
Lilac



Realizzati in PVC espanso  
Made of foam PVC  
R alis s en PVC expans   
Hergestellt aus versch umtem PVC  
Realizadas en espuma de PVC  
Изготовлено из вспененного ПВХ

100%  
made in Italy

### 975555 - G•TINTA UNITA

55 x 55 x 0,8 cm

PER DOCCIA  
FOR SHOWER



### 973782 - G•TINTA UNITA

82 x 36 x 0,8 cm

PER VASCA  
FOR BATHTUB



02

Bianco  
White



Realizzati in PVC  
Made of PVC  
R alis s en PVC  
Hergestellt aus PVC  
Realizadas en PVC  
Изготовлено из ПВХ

### TAVA403 - G•DUCK

70x35x0,5 cm

PER VASCA  
FOR BATHTUB



00

Trasparente  
Transparent





**Realizzati in PVC**  
 Made of PVC  
 Réalisés en PVC  
 Hergestellt aus PVC  
 Realizadas en PVC  
 Изготовлено из ПВХ

### TADO401 - G•RIVER

54 x 54 x 0,7 cm

PER DOCCIA  
 FOR SHOWER



### TAVA401 - G•RIVER

70 x 35 x 0,7 cm

PER VASCA  
 FOR BATHTUB



**00**

Trasparente  
 Transparent

**08**

Grigio  
 Grey



**Realizzati in PVC**  
 Made of PVC  
 Réalisés en PVC  
 Hergestellt aus PVC  
 Realizadas en PVC  
 Изготовлено из ПВХ

### TADO400 - G•SOLID

53 x 53 x 0,7 cm

PER DOCCIA  
 FOR SHOWER

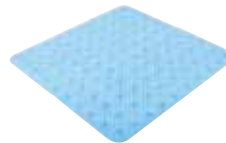

### TAVA400 - G•SOLID

69 x 38,5 x 0,7 cm

PER VASCA  
 FOR BATHTUB



**00**

Trasparente  
 Transparent

**02**

Bianco  
 White

**P1**

Azzurro  
 trasparente  
 Transparent  
 light blue

**P8**

Verde  
 trasparente  
 Transparent  
 green



**Realizzati in PVC**  
 Made of PVC  
 Réalisés en PVC  
 Hergestellt aus PVC  
 Realizadas en PVC  
 Изготовлено из ПВХ

### TADO402 - G•MAIM

50 x 50 x 0,4 cm

PER DOCCIA  
 FOR SHOWER



### TAVA402 - G•MAIM

60 x 0,4 x 38 cm

PER VASCA  
 FOR BATHTUB



**Novità - New**

**NEW**

**00**

Trasparente  
 Transparent

**02**

Bianco  
 White

**P1**

Azzurro  
 trasparente  
 Transparent  
 light blue



**Realizzati in vinile**  
 Made of vinyl  
 Réalisés en vinyl  
 Hergestellt aus Vinyl  
 Realizadas en vinilo  
 Изготовлено из винила

### CO5656 - G•PIETRA

53,5 x 1 x 53,5 cm

PER DOCCIA  
 FOR SHOWER

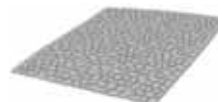

### CO3475 - G•PIETRA

38 x 1 x 74,5 cm

PER VASCA  
 FOR BATHTUB



**02**

Bianco  
 White

**08**

Grigio  
 Grey

**85**

Antracite  
 Anthracite

**Realizzati in vinile**

Made of vinyl

Réalisés en vinyl

Hergestellt aus Vinyl

Realizadas en vinilo

Изготовлено из винила

**CO5555 - G•CUORE**

53 x 0,6 x 53 cm

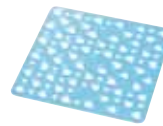
PER DOCCIA  
FOR SHOWER**CO3675 - G•CUORE**

35,5 x 0,6 x 71,5 cm

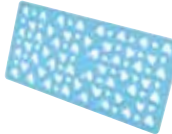
PER VASCA  
FOR BATHTUBTrasparente  
TransparentAzzurro  
Light blue**Realizzato in gomma**

Made of rubber

Réalisé en caoutchouc

Hergestellt aus Gummi

Realizadas en goma

Изготовлено из каучука

**100%**  
made in Italy
 

**985555 - G•GIOTTO**

54,5 x 54,5 x 0,5 cm

PER DOCCIA  
FOR SHOWER**983979 - G•GIOTTO**

79 x 39,5 x 0,5 cm

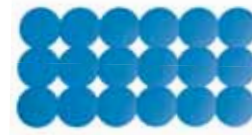
PER VASCA  
FOR BATHTUBBianco  
WhiteVerde acido  
Acid greenAzzurro  
Light blueArancio  
Orange



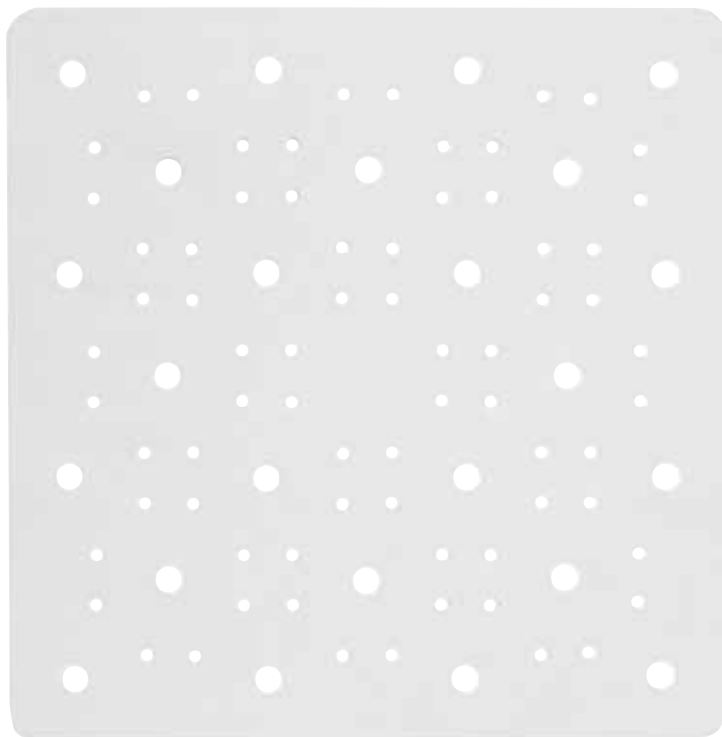

Realizzati in gomma  
Made of rubber  
Réalisés en caoutchouc  
Hergestellt aus Gummi  
Realizadas en goma  
Изготовлено из каучука

100%  
made in Italy

### 985353 - G•TINTA UNITA

52,5 x 52,5 x 0,6 cm

PER DOCCIA  
FOR SHOWER



### 983672 - G•TINTA UNITA

71 x 36 x 0,6 cm

PER VASCA  
FOR BATHTUB

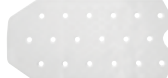

02

Bianco  
White



Realizzati in gomma  
Made of rubber  
Réalisés en caoutchouc  
Hergestellt aus Gummi  
Realizadas en goma  
Изготовлено из каучука

100%  
made in Italy

### 975353 - G•GEO

51,5 x 0,6 x 51,5 cm

PER DOCCIA  
FOR SHOWER



### 973671 - G•GEO

35 x 0,6 x 68 cm

PER VASCA  
FOR BATHTUB



02

Bianco  
White

03

Beige  
Beige

04

Verde acido  
Acid green

05

Blu  
Blue

11

Azzurro  
Light blue

67

Arancio  
Orange

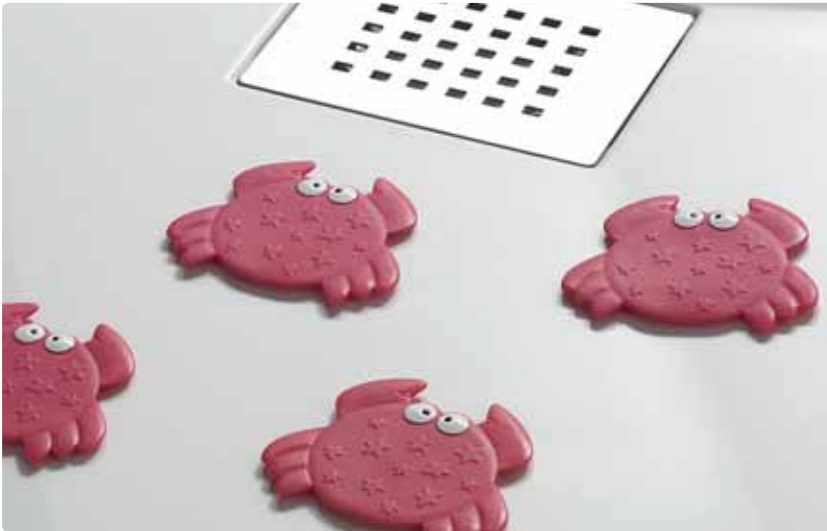

Realizzati in PVC  
Made of PVC  
Réalisés en PVC  
Hergestellt aus PVC  
Realizadas en PVC  
Изготовлено из ПВХ

### TANP404 - G•CRABBY

12,5X8,5X0,5 cm - 4 pz./pcs

06

Rosso  
Red



Realizzati in PVC  
Made of PVC  
Réalisés en PVC  
Hergestellt aus PVC  
Realizadas en PVC  
Изготовлено из ПВХ

### TANP405 - G•DAISY

12,5X8,5X0,5 cm - 4 pz./pcs

10

Rosa  
Pink



Realizzati in PVC  
Made of PVC  
Réalisés en PVC  
Hergestellt aus PVC  
Realizadas en PVC  
Изготовлено из ПВХ

### TANP406 - G•DUFFY

12,5X8,5X0,5 cm - 4 pz./pcs

09

Giallo  
Yellow



# Pedane doccia

Shower platforms  
Caillebotis  
Duschroste  
Tarimas para ducha  
Решетки для душа

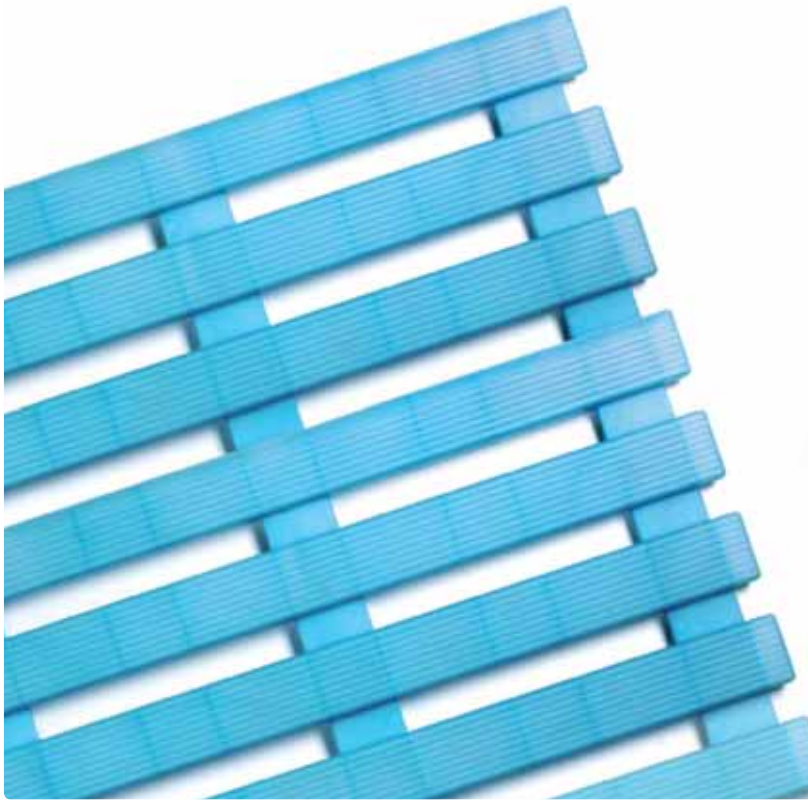

## Realizzata in resine termoplastiche

Made of thermoplastic resins  
Réalisé en thermoplastique  
Hergestellt aus Kunststoff  
Realizada en resinas termoplásticas  
Изготовлено из термопластичных смол

### CO83 - G•LIDO

58,2 x 57,5 x 3 cm

PER DOCCIA  
FOR SHOWER



#### Con piedini in gomma antiscivolo

With non-slip rubber feet  
Avec des pieds  
en caoutchouc antidérapants  
Mit rutschfesten Gummifüßen  
Con pies de goma antideslizantes  
С опорными ножками из нескользящей резины



Bianco  
White



Azzurro  
Light blue

100%  
made in Italy

## Realizzata in resine termoplastiche

Made of thermoplastic resins  
Réalisé en thermoplastique  
Hergestellt aus Kunststoff  
Realizada en resinas termoplásticas  
Изготовлено из термопластичных смол

### 8083 - G•SPIRALE

54,5 x 2,2 x 54,5 cm

PER DOCCIA  
FOR SHOWER



100%  
made in Italy



Bianco  
White



Grigio  
Grey



Tortora  
Turtledove  
grey



# Tappetino lavello

Sink-Mat - Tapis évier - Spülbeckenmatte  
Alfombrilla lavabo - Коврик для раковины

Novità - New



Realizzati in PVC  
Made of PVC  
Réalisés en PVC  
Hergestellt aus PVC  
Realizadas en PVC  
Изготовлено из ПВХ

## TALA501 - G•STAMP

30 x 30 x 0,4 cm

## TALA502 - G•STAMP

30 x 38 x 0,4 cm

## TALA503 - G•STAMP

ø 30 x 0,4 cm

00 02

Trasparente Bianco  
Transparent White

100%  
made in Italy

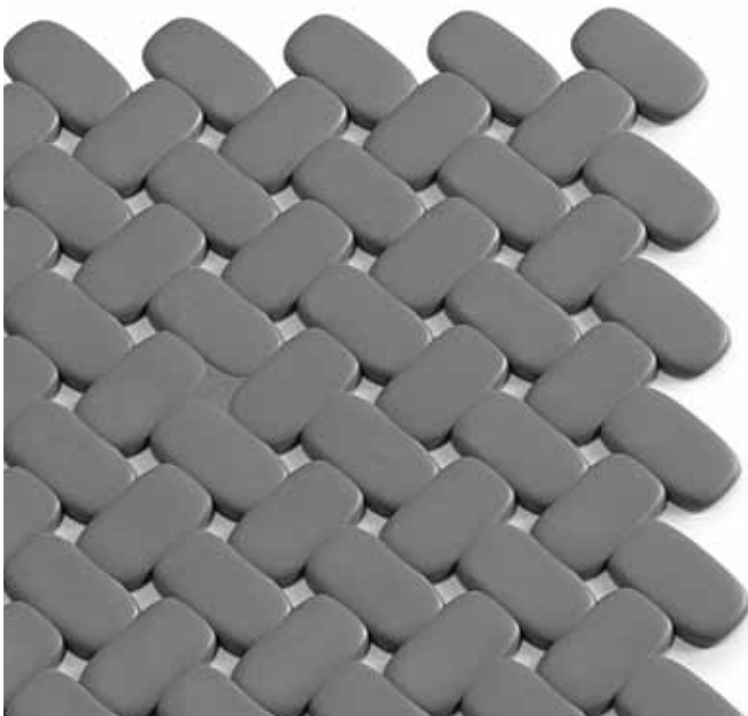
Realizzati in PVC  
Made of PVC  
Réalisés en PVC  
Hergestellt aus PVC  
Realizadas en PVC  
Изготовлено из ПВХ

## TALA505 - G•BRICKS

26 x 26 x 0,3 cm

00 08

Trasparente Grigio  
Transparent Grey

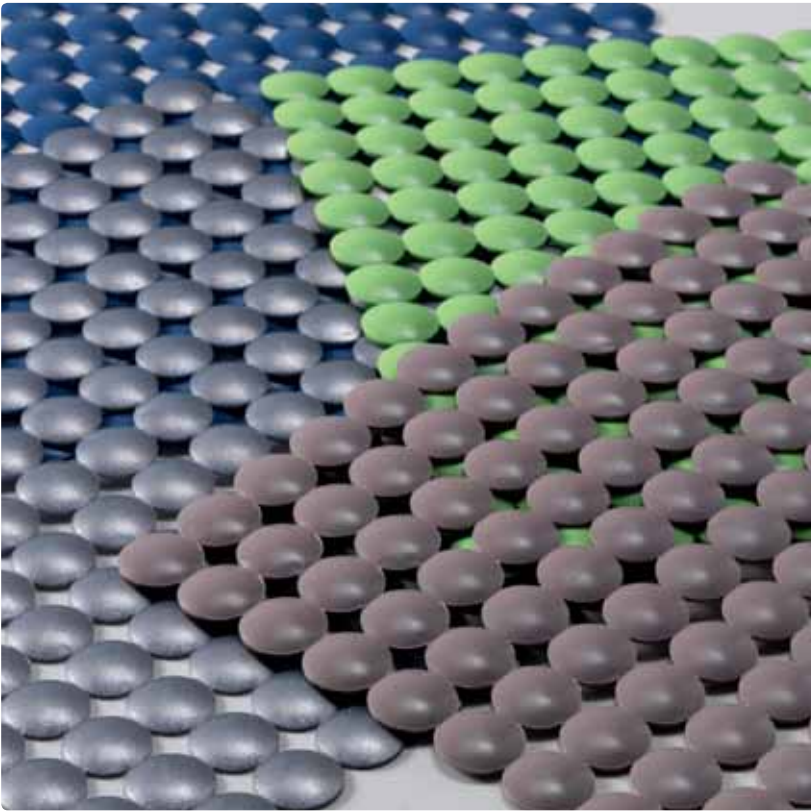

**Realizzati in polipropilene**  
 Made of polypropylene  
 Réalisés en polypropylène  
 Hergestellt aus Polypropylen  
 Realizadas en polipropileno  
 Изготовлено из полипропилена

### TALA500 - G•SOAP

32 x 32 x 0,3 cm

100%  
 made in Italy



<b>04</b>	<b>05</b>	<b>66</b>	<b>73</b>
Verde acido Acid green	Blu Blue	Tortora chiaro Light turtledove grey	Argento Silver



**Realizzati in PVC**  
 Made of PVC  
 Réalisés en PVC  
 Hergestellt aus PVC  
 Realizadas en PVC  
 Изготовлено из ПВХ

### TALA504 - G•LAPIS

26 x 26 x 0,3 cm

<b>00</b>	<b>08</b>
Trasparente Transparent	Grigio Grey

# Sedili per doccia e vasca

Shower and bath tub seats  
Sièges pour douche et baignoire  
Dusch- und  
Badewannensitze  
Asientos para ducha y bañera  
Сидение в душ и ванну



## 6083 - G•PRIMA CLASSE

35,5 x 37 x 10,5 cm

Design: Studio Talocci



**Sedile ribaltabile per doccia  
alluminio/ABS**

Shower seat - aluminum/ABS

Siège pour douche repliable  
aluminium/ABS

Duschsitz hochklappbar

Aluminium/ABS

Asiento abatible para ducha

aluminio/ABS

Сиденье для ABS-пластик



Bianco  
White



Bianco  
cromato  
White  
chromed



Antracite  
cromato  
Anthracite/  
chromed



## 2284 - G•SICURA

64 x 32,4 x 18,3 cm

**Braccioli estensibili per vasche  
con misura interna di 50-65 cm**

Extendable arms for bathtubs with internal  
measurement 50-60 cm

Bras extensibles pour baignoires  
aux dimensions intérieures de 50-60 cm

Verlängerbare Armlehnen für Wannen  
mit einem Innenmaß von 50-60 cm

Apoyabrazos extensibles para bañeras  
con medidas interiores de 50-60 cm

Выдвижные поручни для ванны,  
имеющей внутреннюю ширину от 50 до 60 см

**Realizzato in resine termoplastiche e alluminio**

Made of thermoplastic resins and aluminum

Réalisé en thermoplastique et aluminium

Hergestellt aus Kunststoff und Aluminium

Realizado en resinas termoplásticas y aluminio

Изготовлено из термопластичных смол и алюминия



Bianco  
White

100  
kg**2283 - G•SICURA**

34,5 x 34,5 x 10,5 cm

**Sedile ribaltabile per doccia**

Tilt-up shower seat

Siège pour douche repliable

Duschsitz hochklappbar

Asiento para ducha abatible

Откидное сиденье в душ

**Realizzato in resine termoplastiche e alluminio**

Made of thermoplastic resins and aluminum

Réalisé en thermoplastique et aluminium

Hergestellt aus Kunststoff und Aluminium

Realizado en resinas termoplásticas y aluminio

Изготовлено из термопластичных смол и алюминия

02

Bianco  
WhiteTEST CONDOTTI DALL'ISTITUTO DI CERTIFICAZIONE QUALITÀ CABIATE (CO)  
TESTED BY ISTITUTO DI CERTIFICAZIONE QUALITÀ CABIATE (CO)120  
kg**2282 - G•SOUND**

38,5 x 35,4 x 15,2 cm

**Sedile ribaltabile per doccia**

Tilt-up shower seat

Siège pour douche repliable

Duschsitz hochklappbar

Asiento para ducha abatible

Откидное сиденье в душ

**Realizzato in resine termoplastiche e acciaio**

Made of thermoplastic resins and steel

Réalisé en thermoplastique et acier

Hergestellt aus Kunststoff und Stahl

Realizado en resinas termoplásticas y acero

Изготовлено из термопластичных смол и стали



02

Bianco  
White

23

Bianco/cromato  
White/chromedTEST CONDOTTI DALL'ISTITUTO DI CERTIFICAZIONE QUALITÀ CABIATE (CO)  
TESTED BY ISTITUTO DI CERTIFICAZIONE QUALITÀ CABIATE (CO)120  
kg**DI82 - G•DINO**

37,5 x 29,5 x 7 cm

**Sedile ribaltabile per doccia**

Tilt-up shower seat

Siège pour douche repliable

Duschsitz hochklappbar

Asiento para ducha abatible

Откидное сидение в душ

**Realizzato in resine termoplastiche**

Thermoplastic resins

Réalisé en thermoplastique

Hergestellt aus Kunststoff

Realizado en resinas termoplásticas

Изготовлено из термопластичных смол

02

Bianco  
White

# Tende doccia

Shower curtains - Rideaux de douche  
Duschvorhänge - Cortinas de baño - Занавески для ванной

## Tende doccia in TESSUTO

### SIMBOLOGIA



100% poliestere impermeabilizzato - 100% waterproof polyester - 100% polyester imperméable - 100% Polyester wasserfest  
100% poliester impermeabilizado - 100% водонепроницаемый полиэстер

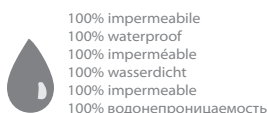

100% impermeabile  
100% waterproof  
100% imperméable  
100% wasserdicht  
100% impermeable  
100% водонепроницаемость



Occhielli in ottone  
Brass eyelets  
Oeillets en laiton  
Messing Ösen  
Ojales de latón  
Латунные проушины



Cucita ai lati (no sfilacciamenti)  
Its sides are sewed to avoid fraying  
Cousue sur les côtés (sans effilochages)  
An den Seiten genäht (kein Ausfransen)  
Cosida en los laterales (no se deshilacha)  
Боковые отстрочки (во избежание разлохмачивания кромок)



Le tende doccia Gedy in tessuto sono realizzate in Poliestere al 100% e trattate per renderle impermeabili e resistenti alle macchie. Il tessuto ed i colori utilizzati sono certificati come completamente atossici. L'orlo inferiore contiene un filo di polipropilene per mantenere la tenda in ordine e sempre tesa. La tenda è fornita completa di anelli. Ogni tenda è garantita per 3 anni.

Les rideaux de douche en tissu de Gedy sont fabriqués en 100% Polyester, ils sont traités à la résine pour les rendre imperméables et résistants aux taches. Le tissu et les couleurs utilisés sont certifiés non-toxiques. L'ourlet en bas contient un fil de polypropylène pour maintenir le rideau rangé et toujours tendu. Le rideau de douche est livré avec anneaux. Chaque rideau est garanti 3 ans.

Las cortinas de baño de tejido Gedy están hechas de 100% poliéster y están tratadas para que sean impermeables y resistentes a las manchas. El tejido y los colores utilizados están certificados como completamente no tóxicos. El borde inferior contiene un hilo de polipropileno para que la cortina esté siempre en orden y extendida. La cortina se suministra con anillas. Todas las cortinas tienen una garantía de 3 años.

Gedy fabric shower curtains are made in Polyester 100% treated with waterproof resin. The raw materials and colours are certified as completely non-toxic. Into the hem there is a polypropylene thread that keeps the curtains always tidy and tight. All curtains are supplied with rings. Each shower curtain features a 3-year warranty.

Gedy Textil-Duschvorhänge bestehen aus 100% Polyester und sind imprägniert und wasser- und schmutzabweisend. Die verwendeten Stoffe und Farben sind als vollständig ungiftig und entsprechend zertifiziert. Im unteren Saum befindet sich ein Beschwerungsband aus Polypropylen, das dafür sorgt, dass der Duschvorhang immer ordentlich bleibt und nach unten fällt. Der Duschvorhang wird komplett mit Vorhangringen geliefert. Jeder Duschvorhang verfügt über 3 Jahre Garantie.

Занавески из ткани Gedy изготовлены из 100% полиэстера с защитной обработкой для обеспечения водонепроницаемости и стойкости к образованию пятен. Используемая ткань и краски прошли сертификацию как полностью нетоксичные. Нижняя кромка с полипропиленовой нитью для поддержания натяжения. К занавеске прилагаются крючки. Каждая занавеска имеет гарантию 3 года.



## G•NEVE

JACQUARD



cod. 1328  
Bianco  
White  
Blanc  
Weiss  
Blanco  
Белый

cm. 120 x 200 **TTE 1328 1230**

cm. 180 x 200 **TTE 1328 1830**

cm. 240 x 200 **TTE 1328 2430**

Anelli inclusi - Rings included  
Anneaux fournis - Ringe enthalten  
Anillas incluidas - Кольца включены



## G•SPIRAGLIO



cod. 1310  
Bianco/Trasparente  
White/Transparent  
Blanc/Transparent  
Weiss/Durchsichtig  
Blanco/Transparente  
Белый/прозрачный

cm. 120 x 200 **TTE 1310 1230**

cm. 180 x 200 **TTE 1310 1830**

cm. 240 x 200 **TTE 1310 2430**

Decoro trasparente in PEVA  
With transparent decoration in PEVA

Anelli incorporati  
Built-in rings  
Anneaux intégrés  
Eingebaute Ringe  
Anillos incorporados  
Кольца включены







## G•BASIC



cod. 1000  
Bianco  
White  
Blanc  
Weiss  
Blanco  
Белый



cod. 1001  
Azzurro  
Light blue  
Bleu ciel  
Hellblau  
Azul celeste  
Голубой

cm. 180 x 200 **TTE 1000 1830**

cm. 180 x 200 **TTE 1001 1830**

Anelli inclusi - Rings included  
Anneaux fournis - Ringe enthalten  
Anillas incluidas - Кольца включены



## G•VANIGLIA

Novità - New



cod. 1003  
Bianco  
White  
Blanc  
Weiss  
Blanco  
Белый

cm. 120 x 200 **TVI 1003 1230**

cm. 180 x 200 **TVI 1003 1830**

cm. 240 x 200 **TVI 1003 2430**

Anelli inclusi - Rings included  
Anneaux fournis - Ringe enthalten  
Anillas incluidas - Кольца включены





## G•ARALDICA



cod. 1325  
Beige  
Beige  
Beige  
Beige  
Beige  
Цвет

cm. 120 x 200 **TTE 1325 1230**

cm. 180 x 200 **TTE 1325 1830**

cm. 240 x 200 **TTE 1325 2430**

Anelli inclusi - Rings included  
Anneaux fournis - Ringe enthalten  
Anillas incluidas - Кольца включены



## G•CAFFÈ



cod. 1302  
Bianco/beige/marrone  
White/beige/brown  
Blanc/beige/marron  
Weiss/beige/braun  
Blanco/beige/marrón  
Белый/цвет шампанского/коричневый

cm. 120 x 200 **TTE 1302 1230**

cm. 180 x 200 **TTE 1302 1830**

cm. 240 x 200 **TTE 1302 2430**

Anelli inclusi - Rings included  
Anneaux fournis - Ringe enthalten  
Anillas incluidas - Кольца включены





## G•CIELO



cod. 1327  
Celeste  
Sky-blue  
Blue  
Himmelblau  
Celeste  
Голубой

cm. 120 x 200 **TTE 1327 1230**

cm. 180 x 200 **TTE 1327 1830**

cm. 240 x 200 **TTE 1327 2430**

Anelli inclusi - Rings included  
Anneaux fournis - Ringe enthalten  
Anillas incluidas - Кольца включены



## G•DESIDERIO



cod. 1355  
Bianco/nero  
White/black  
Blanc/noir  
Weiss/schwarz  
Blanco/negro  
Черный/белый

cm. 120 x 200 **TTE 1355 1230**

cm. 180 x 200 **TTE 1355 1830**

cm. 240 x 200 **TTE 1355 2430**

Anelli inclusi - Rings included  
Anneaux fournis - Ringe enthalten  
Anillas incluidas - Кольца включены





## G•ELEGANCE



cod. 1316  
Bianco/grigio/nero  
White/grey/black  
Blanc/gris/noir  
Weiss/grau/schwarz  
Blanco/gris/negro  
Черный/серый/белый

cm. 120 x 200 **TTE 1316 1230**

cm. 180 x 200 **TTE 1316 1830**

cm. 240 x 200 **TTE 1316 2430**

Anelli inclusi - Rings included  
Anneaux fournis - Ringe enthalten  
Anillas incluidas - Кольца включены



## G•EUCALIPTO



cod. 1304  
Verde  
Green  
Vert  
Grün  
Verde  
Зелёный

cm. 120 x 200 **TTE 1304 1230**

cm. 180 x 200 **TTE 1304 1830**

cm. 240 x 200 **TTE 1304 2430**

Anelli inclusi - Rings included  
Anneaux fournis - Ringe enthalten  
Anillas incluidas - Кольца включены





## G•FLORA



cod. 1320  
Rosa/giallo  
Pink/yellow  
Rose/jaune  
Rosa/gelb  
Rosa/amarillo  
Розовый/желтый

cm. 120 x 200 **TTE 1320 1230**

cm. 180 x 200 **TTE 1320 1830**

cm. 240 x 200 **TTE 1320 2430**

Anelli inclusi - Rings included  
Anneaux fournis - Ringe enthalten  
Anillas incluidas - Кольца включены



## G•FRAMMENTI



cod. 1315  
Blu  
Blue  
Bleu  
Blau  
Azulón  
Синий

cm. 120 x 200 **TTE 1315 1230**

cm. 180 x 200 **TTE 1315 1830**

cm. 240 x 200 **TTE 1315 2430**

Anelli inclusi - Rings included  
Anneaux fournis - Ringe enthalten  
Anillas incluidas - Кольца включены







## G•FRENESIA



cod. 1303  
 Rosa/giallo/turchese  
 Pink/yellow/turquoise  
 Rose/jaune/turquoise  
 Rosa/gelb/türkis  
 Rosa/amarillo/turquesa  
 Розовый/желтый/брюзовый цвет

cm. 120 x 200 **TTE 1303 1230**

cm. 180 x 200 **TTE 1303 1830**

cm. 240 x 200 **TTE 1303 2430**

Anelli inclusi - Rings included  
 Anneaux fournis - Ringe enthalten  
 Anillas incluidas - Кольца включены



## G•FRIZZ



cod. 1313  
 Blu  
 Blue  
 Bleu  
 Blau  
 Azulón  
 Синий

cm. 120 x 200 **TTE 1313 1230**

cm. 180 x 200 **TTE 1313 1830**

cm. 240 x 200 **TTE 1313 2430**

Anelli inclusi - Rings included  
 Anneaux fournis - Ringe enthalten  
 Anillas incluidas - Кольца включены







## G•GOMITOLO



cod. 1326  
Verde/marrone  
Green/brown  
Vert/marron  
Grün/braun  
Verde/marrón  
Зелёный/коричневый

cm. 120 x 200 **TTE 1326 1230**

cm. 180 x 200 **TTE 1326 1830**

cm. 240 x 200 **TTE 1326 2430**

Anelli inclusi - Rings included  
Anneaux fournis - Ringe enthalten  
Anillas incluidas - Кольца включены

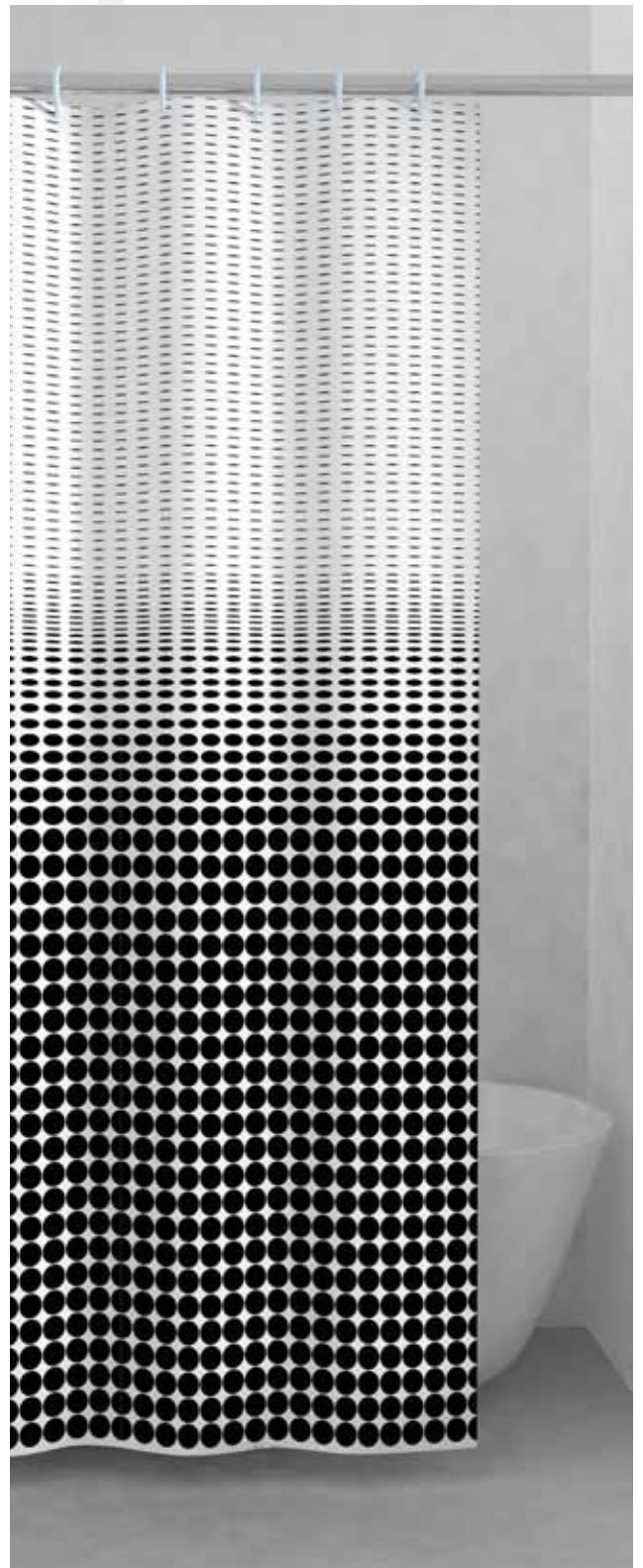

## G•IPNOSI



cod. 1314  
Bianco/nero  
White/black  
Blanc/noir  
Weiss/schwarz  
Blanco/negro  
Чёрный/белый

cm. 120 x 200 **TTE 1314 1230**

cm. 180 x 200 **TTE 1314 1830**

cm. 240 x 200 **TTE 1314 2430**

Anelli inclusi - Rings included  
Anneaux fournis - Ringe enthalten  
Anillas incluidas - Кольца включены



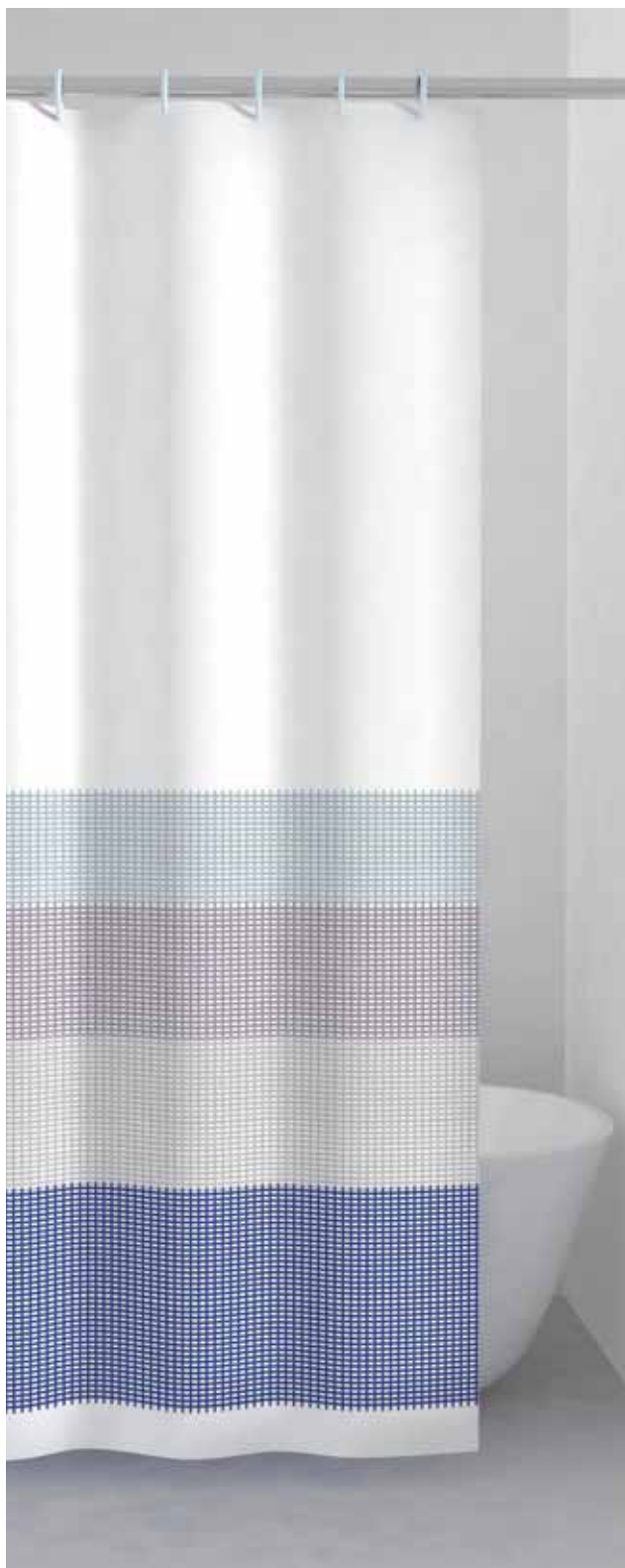

## G•JEANS



cod. 1307  
 Multicolore  
 Multicolor  
 Multicolore  
 Mehrfarbig  
 Multicolor  
 Разноцветный

cm. 120 x 200 **TTE 1307 1230**

cm. 180 x 200 **TTE 1307 1830**

cm. 240 x 200 **TTE 1307 2430**

Anelli inclusi - Rings included  
 Anneaux fournis - Ringe enthalten  
 Anillas incluidas - Кольца включены



## G•LADY MARY



cod. 1305  
 Grigio/Rosa  
 Grey/Pink  
 Gris/Rose  
 Grau/Rosa  
 Gris/Rosa  
 Серый/Розовый

cm. 120 x 200 **TTE 1305 1230**

cm. 180 x 200 **TTE 1305 1830**

cm. 240 x 200 **TTE 1305 2430**

Anelli inclusi - Rings included  
 Anneaux fournis - Ringe enthalten  
 Anillas incluidas - Кольца включены





## G•LIVING



cod. 1323  
 Beige/bianco/nero  
 Beige/white/black  
 Beige/blanc/noir  
 Beige/weiss/schwarz  
 Beige/blanco/negro  
 бежевый/черный/белый

cm. 120 x 200 **TTE 1323 1230**

cm. 180 x 200 **TTE 1323 1830**

cm. 240 x 200 **TTE 1323 2430**

Anelli inclusi - Rings included  
 Anneaux fournis - Ringe enthalten  
 Anillas incluidas - Кольца включены



## G•OLTREMARE



cod. 1306  
 Beige/azzurro  
 Beige/light blue  
 Beige/bleu ciel  
 Beige/Hellblau  
 Beige/azul celeste  
 бежевый/Голубой

cm. 120 x 200 **TTE 1306 1230**

cm. 180 x 200 **TTE 1306 1830**

cm. 240 x 200 **TTE 1306 2430**

Anelli inclusi - Rings included  
 Anneaux fournis - Ringe enthalten  
 Anillas incluidas - Кольца включены





## G•ORIZZONTI



cod. 1301  
Celeste  
Sky-blue  
Bleu ciel  
Himmelblau  
Celeste  
Голубой

cm. 120 x 200 **TTE 1301 1230**

cm. 180 x 200 **TTE 1301 1830**

cm. 240 x 200 **TTE 1301 2430**

Anelli inclusi - Rings included  
Anneaux fournis - Ringe enthalten  
Anillas incluidas - Кольца включены



## G•PARALLELE



cod. 1321  
Grigio  
Grey  
Gris  
Grau  
Gris  
Серый

cm. 120 x 200 **TTE 1321 1230**

cm. 180 x 200 **TTE 1321 1830**

cm. 240 x 200 **TTE 1321 2430**

Anelli inclusi - Rings included  
Anneaux fournis - Ringe enthalten  
Anillas incluidas - Кольца включены







## G•PARFUME



cod. 1322  
Bianco/nero  
White/black  
Blanc/noir  
Weiss/schwarz  
Blanco/negro  
Черный/белый

cm. 120 x 200 **TTE 1322 1230**

cm. 180 x 200 **TTE 1322 1830**

cm. 240 x 200 **TTE 1322 2430**

Anelli inclusi - Rings included  
Anneaux fournis - Ringe enthalten  
Anillas incluidas - Кольца включены



## G•PIPER



cod. 1318  
Beige/nero  
Beige/black  
Beige/noir  
Beige/schwarz  
Beige/negro  
бежевый/белый

cm. 120 x 200 **TTE 1318 1230**

cm. 180 x 200 **TTE 1318 1830**

cm. 240 x 200 **TTE 1318 2430**

Anelli inclusi - Rings included  
Anneaux fournis - Ringe enthalten  
Anillas incluidas - Кольца включены





## G•RICORDI



cod. 1324  
Celeste/turchese/nero  
Sky-blue/turquoise/black  
Bleu/turquoise/noir  
Himmelblau/türkis/schwarz  
Celeste/turquesa/negro  
Голубой/брюзовый цвет/белый

cm. 120 x 200 **TTE 1324 1230**

cm. 180 x 200 **TTE 1324 1830**

cm. 240 x 200 **TTE 1324 2430**

Anelli inclusi - Rings included  
Anneaux fournis - Ringe enthalten  
Anillas incluidas - Кольца включены



## G•RIVA



cod. 1309  
Blu  
Blue  
Bleu  
Blau  
Azulón  
Синий

cm. 120 x 200 **TTE 1309 1230**

cm. 180 x 200 **TTE 1309 1830**

cm. 240 x 200 **TTE 1309 2430**

Anelli inclusi - Rings included  
Anneaux fournis - Ringe enthalten  
Anillas incluidas - Кольца включены







## G•SPIAGGIA



cod. 1317  
Beige/marrone  
Beige/brown  
Beige/marron  
Beige/braun  
Beige/marrón  
Бежевый/коричневый

cm. 120 x 200 **TTE 1317 1230**

cm. 180 x 200 **TTE 1317 1830**

cm. 240 x 200 **TTE 1317 2430**

Anelli inclusi - Rings included  
Anneaux fournis - Ringe enthalten  
Anillas incluidas - Кольца включены



## G•STANCIL



cod. 1319  
Grigio  
Grey  
Gris  
Gru  
Gris  
Серый

cm. 120 x 200 **TTE 1319 1230**

cm. 180 x 200 **TTE 1319 1830**

cm. 240 x 200 **TTE 1319 2430**

Anelli inclusi - Rings included  
Anneaux fournis - Ringe enthalten  
Anillas incluidas - Кольца включены



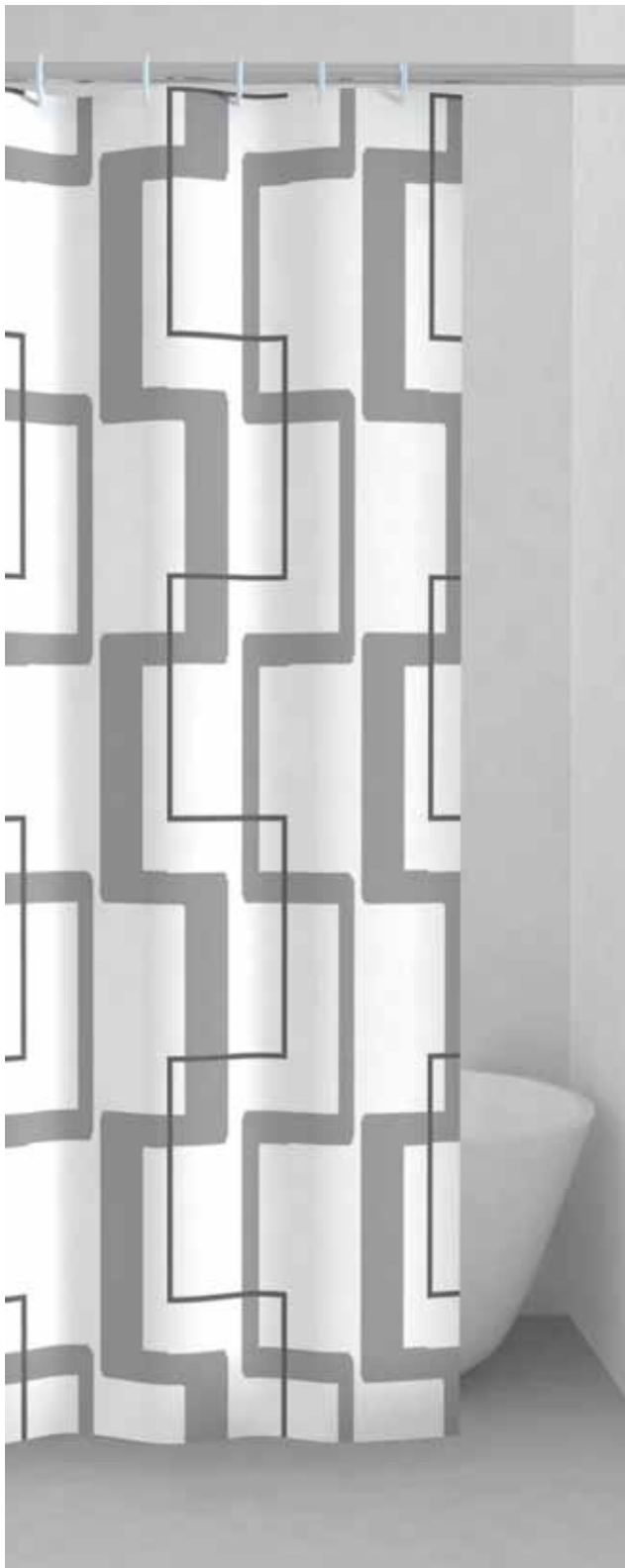

## G•TECNO



cod. 1308  
Grigio  
Grey  
Gris  
Grau  
Gris  
Серый

cm. 120 x 200 **TTE 1308 1230**

cm. 180 x 200 **TTE 1308 1830**

cm. 240 x 200 **TTE 1308 2430**

Anelli inclusi - Rings included  
Anneaux fournis - Ringe enthalten  
Anillas incluidas - Кольца включены



## G•TRATTO



cod. 1312  
Celeste/turchese  
Sky-blue/turquoise  
Bleu/turquoise  
Himmelblau/türkis  
Celeste/turquesa  
Голубой/брюзовый цвет

cm. 120 x 200 **TTE 1312 1230**

cm. 180 x 200 **TTE 1312 1830**

cm. 240 x 200 **TTE 1312 2430**

Anelli inclusi - Rings included  
Anneaux fournis - Ringe enthalten  
Anillas incluidas - Кольца включены





## G•VIVAIO



cod. 1311  
Verde  
Green  
Vert  
Grün  
Verde  
Зелёный

cm. 120 x 200 **TTE 1311 1230**

cm. 180 x 200 **TTE 1311 1830**

cm. 240 x 200 **TTE 1311 2430**

Anelli inclusi - Rings included  
Anneaux fournis - Ringe enthalten  
Anillas incluidas - Кольца включены



# Tende doccia

Shower curtains - Rideaux de douche  
Duschvorhänge - Cortinas de baño - Занавески для ванной

## SIMBOLOGIA



## Tende doccia in PEVA

Il PEVA è un materiale ecologico riciclabile senza dispersione di sostanze tossiche nell'ambiente. Completamente inodore - Spessore consistente per evitare che la tenda aderisca al corpo durante la doccia. La tenda è fornita completa di anelli.

Le PEVA est un matériau écologique recyclable sans dispersion de substances toxiques dans l'environnement - complètement inodore - grande épaisseur pour éviter que le rideau n'adhère au corps pendant la douche. Le rideau de douche est livré avec anneaux.

El PEVA es un material ecológico reciclable sin dispersión de sustancias tóxicas en el medio ambiente - completamente inodoro - de gran grosor para evitar que la cortina se adhiera al cuerpo durante la ducha. La cortina se suministra con anillas.

PEVA is an eco-friendly material that can be recycled without leaking toxic substances into the environment - completely odour free - and featuring adequate thickness to prevent the curtain from sticking to the body when showering. All curtains are supplied with rings.

PEVA ist ein ökologisches Material, das sich recyceln lässt, ohne dass giftige Stoffe in die Umwelt gelangen - völlig geruchlos - dickes Material, um zu verhindern, dass der Vorhang beim Duschen am Körper haften bleibt. Der Duschvorhang wird mit Vorhangringen geliefert.

PEVA - это экологичный рециклируемый материал, не выделяющий вредных веществ в окружающую среду - абсолютно лишен запаха - повышенная плотность во избежание прилипания шторки к телу во время принятия душа. К занавеске прилагаются крючки.



**G•ICE**

**DECORO 3D  
3D PATTERN**



cod. 1357  
Bianco  
White  
Blanc  
Weiss  
Blanco  
Белый

cm. 180 x 200 **TVI 1357 1830**

Anelli inclusi - Rings included  
Anneaux fournis - Ringe enthalten  
Anillas incluidas - Кольца включены



**G•SQUARE**

**DECORO 3D  
3D PATTERN**



cod. 1358  
Bianco  
White  
Blanc  
Weiss  
Blanco  
Белый



cod. 1359  
Azzurro  
Light blue  
Bleu ciel  
Hellblau  
Azul celeste  
Голубой

cm. 180 x 200 **TVI 1358 1830**  
cm. 180 x 200 **TVI 1359 1830**

Anelli inclusi - Rings included  
Anneaux fournis - Ringe enthalten  
Anillas incluidas - Кольца включены





## G•VETRO

**DECORO 3D  
3D PATTERN**



cod. 1356  
Bianco  
White  
Blanc  
Weiss  
Blanco  
Белый

cm. 180 x 200 **TVI 1356 1830**

Anelli inclusi - Rings included  
Anneaux fournis - Ringe enthalten  
Anillas incluidas - Кольца включены



## G•BASIC



cod. 1000  
Bianco  
White  
Blanc  
Weiss  
Blanco  
Белый



cod. 1001  
Azzurro  
Light blue  
Bleu ciel  
Hellblau  
Azul celeste  
Голубой

cm. 180 x 200 **TVI 1000 1830**  
cm. 180 x 200 **TVI 1001 1830**

Anelli inclusi - Rings included  
Anneaux fournis - Ringe enthalten  
Anillas incluidas - Кольца включены







**G•ZUCCHERO**

**Novità - New**



cod. 1002  
Bianco  
White  
Blanc  
Weiss  
Blanco  
Белый

cm. 120 x 200 **TTE 1002 1230**

cm. 180 x 200 **TTE 1002 1830**

cm. 240 x 200 **TTE 1002 2430**

Anelli inclusi - Rings included  
Anneaux fournis - Ringe enthalten  
Anillas incluidas - Кольца включены



**G•BIGLIE**



cod. 1341  
Verde/blu  
Green/blue  
Vert/bleu  
Grün/Blau  
Verde/azulón  
Зелёный/синий

cm. 120 x 200 **TVI 1341 1230**

cm. 180 x 200 **TVI 1341 1830**

cm. 240 x 200 **TVI 1341 2430**

Anelli inclusi - Rings included  
Anneaux fournis - Ringe enthalten  
Anillas incluidas - Кольца включены





## G•CIOTOLI



cod. 1344  
Azzurro  
Light blue  
Bleu ciel  
Hellblau  
Azul celeste  
Голубой

cm. 120 x 200 **TVI 1344 1230**

cm. 180 x 200 **TVI 1344 1830**

cm. 240 x 200 **TVI 1344 2430**

Anelli inclusi - Rings included  
Anneaux fournis - Ringe enthalten  
Anillas incluidas - Кольца включены



## G•CIRCLES



cod. 1351  
Grigio/aquamarina  
Grey/aquamarine  
Gris/eau verte  
Grau/aquamarinblau  
Gris/aquamarina  
Серый/аквамарин

cm. 120 x 200 **TVI 1351 1230**

cm. 180 x 200 **TVI 1351 1830**

cm. 240 x 200 **TVI 1351 2430**

Anelli inclusi - Rings included  
Anneaux fournis - Ringe enthalten  
Anillas incluidas - Кольца включены





## G•DOMINO



cod. 1329  
Grigio  
Grey  
Gris  
Grau  
Gris  
Серый

cm. 120 x 200 **TVI 1329 1230**

cm. 180 x 200 **TVI 1329 1830**

cm. 240 x 200 **TVI 1329 2430**

Anelli inclusi - Rings included  
Anneaux fournis - Ringe enthalten  
Anillas incluidas - Кольца включены



## G•FOLIAGE



cod. 1353  
Grigio  
Grey  
Gris  
Grau  
Gris  
Серый

cm. 120 x 200 **TVI 1353 1230**

cm. 180 x 200 **TVI 1353 1830**

cm. 240 x 200 **TVI 1353 2430**

Anelli inclusi - Rings included  
Anneaux fournis - Ringe enthalten  
Anillas incluidas - Кольца включены





## G•FRAME



cod. 1349  
Azzurro/grigio  
Light blue/grey  
Bleu ciel/gris  
Hellblau/grau  
Azul celeste/gris  
Голубой/серый

cm. 120 x 200 **TVI 1349 1230**

cm. 180 x 200 **TVI 1349 1830**

cm. 240 x 200 **TVI 1349 2430**

Anelli inclusi - Rings included  
Anneaux fournis - Ringe enthalten  
Anillas incluidas - Кольца включены



## G•FRAMMENTI



cod. 1315  
Azzurro  
Light blue  
Bleu ciel  
Hellblau  
Azul celeste  
Голубой

cm. 120 x 200 **TVI 1315 1230**

cm. 180 x 200 **TVI 1315 1830**

cm. 240 x 200 **TVI 1315 2430**

Anelli inclusi - Rings included  
Anneaux fournis - Ringe enthalten  
Anillas incluidas - Кольца включены





## G•INCANTO



cod. 1352  
 Grigio  
 Grey  
 Gris  
 Grau  
 Gris  
 Серый

cm. 120 x 200 **TVI 1352 1230**

cm. 180 x 200 **TVI 1352 1830**

cm. 240 x 200 **TVI 1352 2430**

Anelli inclusi - Rings included  
 Anneaux fournis - Ringe enthalten  
 Anillas incluidas - Кольца включены



## G•JUMP



cod. 1331  
 Azzurro  
 Light blue  
 Bleu ciel  
 Hellblau  
 Azul celeste  
 Голубой

cm. 120 x 200 **TVI 1331 1230**

cm. 180 x 200 **TVI 1331 1830**

cm. 240 x 200 **TVI 1331 2430**

Anelli inclusi - Rings included  
 Anneaux fournis - Ringe enthalten  
 Anillas incluidas - Кольца включены







## G•JUNGLE



cod. 1342  
Bianco  
White  
Blanc  
Weiss  
Blanco  
Белый

cm. 120 x 200 **TVI 1342 1230**

cm. 180 x 200 **TVI 1342 1830**

cm. 240 x 200 **TVI 1342 2430**

Anelli inclusi - Rings included  
Anneaux fournis - Ringe enthalten  
Anillas incluidas - Кольца включены



## G•LENS



cod. 1346  
Bianco  
White  
Blanc  
Weiss  
Blanco  
Белый

cm. 120 x 200 **TVI 1346 1230**

cm. 180 x 200 **TVI 1346 1830**

cm. 240 x 200 **TVI 1346 2430**

Anelli inclusi - Rings included  
Anneaux fournis - Ringe enthalten  
Anillas incluidas - Кольца включены







## G•LIANE



cod. 1343  
 Multicolore  
 Multicolor  
 Multicolore  
 Mehrfarbig  
 Multicolor  
 Разноцветный

cm. 120 x 200 **TVI 1343 1230**

cm. 180 x 200 **TVI 1343 1830**

cm. 240 x 200 **TVI 1343 2430**

Anelli inclusi - Rings included  
 Anneaux fournis - Ringe enthalten  
 Anillas incluidas - Кольца включены



## G•NIDI



cod. 1333  
 Grigio  
 Grey  
 Gris  
 Grau  
 Gris  
 Серый

cm. 120 x 200 **TVI 1333 1230**

cm. 180 x 200 **TVI 1333 1830**

cm. 240 x 200 **TVI 1333 2430**

Anelli inclusi - Rings included  
 Anneaux fournis - Ringe enthalten  
 Anillas incluidas - Кольца включены





## G•OBLÒ



cod. 1348  
Azzurro  
Light blue  
Bleu ciel  
Hellblau  
Azul celeste  
Голубой

cm. 120 x 200 **TVI 1348 1230**

cm. 180 x 200 **TVI 1348 1830**

cm. 240 x 200 **TVI 1348 2430**

Anelli inclusi - Rings included  
Anneaux fournis - Ringe enthalten  
Anillas incluidas - Кольца включены



## G•ORBITA



cod. 1340  
Azzurro  
Light blue  
Bleu ciel  
Hellblau  
Azul celeste  
Голубой

cm. 120 x 200 **TVI 1340 1230**

cm. 180 x 200 **TVI 1340 1830**

cm. 240 x 200 **TVI 1340 2430**

Anelli inclusi - Rings included  
Anneaux fournis - Ringe enthalten  
Anillas incluidas - Кольца включены





## G•PARADISE



cod. 1347  
 Multicolore  
 Multicolor  
 Multicolore  
 Mehrfarbig  
 Multicolor  
 Разноцветный

cm. 120 x 200 **TVI 1347 1230**

cm. 180 x 200 **TVI 1347 1830**

cm. 240 x 200 **TVI 1347 2430**

Anelli inclusi - Rings included  
 Anneaux fournis - Ringe enthalten  
 Anillas incluidas - Кольца включены



## G•PARTY



cod. 1330  
 Multicolore  
 Multicolor  
 Multicolore  
 Mehrfarbig  
 Multicolor  
 Разноцветный

cm. 120 x 200 **TVI 1330 1230**

cm. 180 x 200 **TVI 1330 1830**

cm. 240 x 200 **TVI 1330 2430**

Anelli inclusi - Rings included  
 Anneaux fournis - Ringe enthalten  
 Anillas incluidas - Кольца включены







## G•POOL



cod. 1332  
Azzurro  
Light blue  
Bleu ciel  
Hellblau  
Azul celeste  
Голубой

cm. 120 x 200 **TVI 1332 1230**

cm. 180 x 200 **TVI 1332 1830**

cm. 240 x 200 **TVI 1332 2430**

Anelli inclusi - Rings included  
Anneaux fournis - Ringe enthalten  
Anillas incluidas - Кольца включены



## G•POT POURRI



cod. 1336  
Lilla/rosa  
Lilla/pink  
Lilas/Rose  
Lilas/rosa  
Fieder/rosa  
Сиреневый/розовый

cm. 120 x 200 **TVI 1336 1230**

cm. 180 x 200 **TVI 1336 1830**

cm. 240 x 200 **TVI 1336 2430**

Anelli inclusi - Rings included  
Anneaux fournis - Ringe enthalten  
Anillas incluidas - Кольца включены





## G•PRISMA



cod. 1350  
Bianco  
White  
Blanc  
Weiss  
Blanco  
Белый

cm. 120 x 200 **TVI 1350 1230**

cm. 180 x 200 **TVI 1350 1830**

cm. 240 x 200 **TVI 1350 2430**

Anelli inclusi - Rings included  
Anneaux fournis - Ringe enthalten  
Anillas incluidas - Кольца включены



## G•RUGIADA



cod. 1338  
Azzurro  
Light blue  
Bleu ciel  
Hellblau  
Azul celeste  
Голубой

cm. 120 x 200 **TVI 1338 1230**

cm. 180 x 200 **TVI 1338 1830**

cm. 240 x 200 **TVI 1338 2430**

Anelli inclusi - Rings included  
Anneaux fournis - Ringe enthalten  
Anillas incluidas - Кольца включены





## G•SCHEMA



cod. 1345  
Celeste/turquoise  
Light blue/turquoise  
Bleu ciel/turquoise  
Hellblau/türkis  
Azul celeste/turquesa  
Голубой/брюзовый цвет

cm. 120 x 200 **TVI 1345 1230**

cm. 180 x 200 **TVI 1345 1830**

cm. 240 x 200 **TVI 1345 2430**

Anelli inclusi - Rings included  
Anneaux fournis - Ringe enthalten  
Anillas incluidas - Кольца включены



## G•STRÜDEL



cod. 1339  
Bianco  
White  
Blanc  
Weiss  
Blanco  
Белый

cm. 120 x 200 **TVI 1339 1230**

cm. 180 x 200 **TVI 1339 1830**

cm. 240 x 200 **TVI 1339 2430**

Anelli inclusi - Rings included  
Anneaux fournis - Ringe enthalten  
Anillas incluidas - Кольца включены







## G•TABLET



cod. 1334  
Azzurro  
Light blue  
Bleu ciel  
Hellblau  
Azul celeste  
Голубой

cm. 120 x 200 **TVI 1334 1230**

cm. 180 x 200 **TVI 1334 1830**

cm. 240 x 200 **TVI 1334 2430**

Anelli inclusi - Rings included  
Anneaux fournis - Ringe enthalten  
Anillas incluidas - Кольца включены



## G•TIC-TOC



cod. 1354  
Bianco  
White  
Blanc  
Weiss  
Blanco  
Белый

cm. 120 x 200 **TVI 1354 1230**

cm. 180 x 200 **TVI 1354 1830**

cm. 240 x 200 **TVI 1354 2430**

Anelli inclusi - Rings included  
Anneaux fournis - Ringe enthalten  
Anillas incluidas - Кольца включены





## G•TRACCE



cod. 1337  
Azzurro  
Light blue  
Bleu ciel  
Hellblau  
Azul celeste  
Голубой

cm. 120 x 200 **TVI 1337 1230**

cm. 180 x 200 **TVI 1337 1830**

cm. 240 x 200 **TVI 1337 2430**

Anelli inclusi - Rings included  
Anneaux fournis - Ringe enthalten  
Anillas incluidas - Кольца включены



## G•TROPICAL



cod. 1335  
Azzurro/giallo  
Light blue/yellow  
Bleu ciel/jaune  
Hellblau/gelb  
Azul celeste/amarillo  
Голубой/желтый

cm. 120 x 200 **TVI 1335 1230**

cm. 180 x 200 **TVI 1335 1830**

cm. 240 x 200 **TVI 1335 2430**

Anelli inclusi - Rings included  
Anneaux fournis - Ringe enthalten  
Anillas incluidas - Кольца включены



# Tende doccia IGNIFUGA

Fire-proof polyester shower curtain  
Rideau de douche en polyester ignifuge  
Duschvorhang aus feuerhemmendem Polyester  
Cortina de ducha de poliéster ignífuga  
Занавеска для душа из огнестойкого полиэстера

## Ignifuga - classe 1

Il tessuto ideale per alberghi e comunità.  
The ideal fabric for hotels and communities.  
Le tissu idéal pour hôtels et communautés.  
Der ideale Stoff für Hotel und Gemeinschaften.  
El material ideal para hoteles y comunidades.  
Идеальная ткань для гостиниц и общественных зданий.



# Pieghella 180°

Pieghella 180° SENZA TENDA  
Pieghella 180° WITHOUT SHOWER CURTAIN  
Pieghella 180° SANS RIDEAU  
Pieghella 180° OHNE VORHANG  
Pieghella 180° SIN CORTINA  
Pieghella 180° БЕЗ ЗАНАВЕСКИ

Reggitenda pieghevole adatto per vasche da bagno e docce. Montaggio semplicissimo con quattro viti e tasselli a muro. Supporto e fissaggio invisibile con bracci d'acciaio.

Fold-away shower rail and curtain. Screws and wall plugs includes. Invisible fixing system with steel arms.

Cabine de douche pliable pour baignoires et douches. Montage très simple avec quatre vis. Support et fixation invisible avec bras en acier.

Duschschirm ausklappbar für Wannen und Duschen aller Grössen. Montage einfachst mit beigefügten Schrauben und Dübeln.

Varillaje para bañeras y duchas. Montaje muy fácil con 4 tornillos y tacos.

Раздвижной карниз для ванн и душевых. Максимально простой монтаж посредством четырех винтов и стеновых дюбелей. Опора и невидимый крепеж со стальными кронштейнами.



Pieghella 8 braccia  
con apertura max 180°

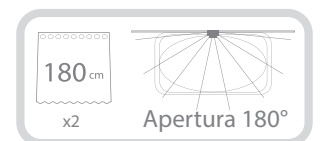
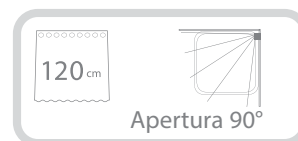

## G•TINTA UNITA



cod. 6129  
Bianco  
White  
Blanc  
Weiss  
Blanco  
Белый

100%  
made in Italy



cm. 120 x 200 **TVI 6129 6712**

cm. 180 x 200 **TVI 6129 6718**

cm. 240 x 200 **TVI 6129 6724**

Anelli inclusi - Rings included  
Anneaux fournis - Ringe enthalten  
Anillas incluidas - Кольца включены



## TPIE 1801310

Realizzate in acciaio inox e resine termoplastiche

Made of stainless steel and thermoplastic resins

Réalisés en acier inoxydable et thermoplastique

Hergestellt aus Edelstahl und Kunststoff

Realizadas en acero inox y resinas termoplásticas

Изготовлено из нержавеющей стали и термопластичных смол

# Anelli per tende doccia

Rings for shower curtains  
Anneaux pour rideaux de douche  
Vorhangringe  
Anillas para cortinas de ducha  
Кольца для занавески

## TANE 100

12 pz./pcs



**Realizzati in resine termoplastiche**  
Made of thermoplastic resins  
Réalisés en thermoplastique  
Hergestellt aus Kunststoff  
Realizadas en resinas termoplásticas  
Изготовлено из термопластичных смол

**00**

Trasparente  
Transparent

**02**

Bianco  
White

# Supporto a soffitto per telai reggitenda - altezza regolabile

Ceiling support for shower rails-height adjustable - Support fixation plafond pour barre de douche (hauteur réglable)  
Deckenhalterung für Duschstangen (höhenverstellbar) - Soporte de techo para barras de ducha (altura regulable)  
Потолочная опора для штанг для занавесок (регулируемая высота)

## TCAV600



**Realizzato in acciaio e ottone**  
Made of steel and brass  
Réalisé en acier et laiton  
Hergestellt aus Stahl und Messing  
Realizado en acero y latón  
Изготовлено из стали и латуни

**13**

Cromato  
Chromed

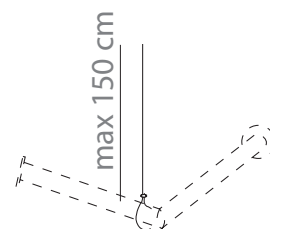

# Asta doccia estensibile

Extensible shower rail  
Barre de douche extensible  
Teleskopduschstange  
Barra extensible para cortinas  
Раздвижная штанга для душа

## TEST700



**02** Alluminio con laccatura epossidica e resine termoplastiche  
Epoxy lacquered aluminium and thermoplastic resins  
Aluminium laquage époxi et thermoplastique  
Aluminium mit Epoxid-Beschichtung und Kunststoff  
Aluminio pintado epoxi y resinas termoplásticas  
Алюминий с эпоксидным покрытием и термопластичные смолы

Bianco  
White



**13** Alluminio anodizzato e resine termoplastiche  
Anodized aluminum and thermoplastic resins  
Aluminium anodisé et thermoplastique  
Eloxiertes Aluminium und Kunststoff  
Aluminio anodizado y resinas termoplásticas  
Анодированный алюминий и термопластичные смолы

Alluminio anodizzato  
Anodized aluminum

Tenda consigliata:  
Recommended shower curtain:  
Rideau de douche recommandé:  
Empfohlene duschvorhang:  
Se recomienda cortina de ducha:  
Рекомендуемая занавеска:

120 cm  
180 cm

Ø 25 mm  
cm 78/135  
spessore/thickness  
Ø 0,6 mm

## TEST701



**02** Alluminio con laccatura epossidica e resine termoplastiche  
Epoxy lacquered aluminium and thermoplastic resins  
Aluminium laquage époxi et thermoplastique  
Aluminium mit Epoxid-Beschichtung und Kunststoff  
Aluminio pintado epoxi y resinas termoplásticas  
Алюминий с эпоксидным покрытием и термопластичные смолы

Bianco  
White



**13** Alluminio anodizzato e resine termoplastiche  
Anodized aluminum and thermoplastic resins  
Aluminium anodisé et thermoplastique  
Eloxiertes Aluminium und Kunststoff  
Aluminio anodizado y resinas termoplásticas  
Анодированный алюминий и термопластичные смолы

Alluminio anodizzato  
Anodized aluminum

Tenda consigliata:  
Recommended shower curtain:  
Rideau de douche recommandé:  
Empfohlene duschvorhang:  
Se recomienda cortina de ducha:  
Рекомендуемая занавеска:

120 cm  
180 cm

cm 80  
Ø 25 mm  
cm 87/150  
spessore/thickness  
Ø 0,6 mm

120 cm  
180 cm

cm 93  
Ø 25 mm  
cm 100/163  
spessore/thickness  
Ø 0,6 mm

180 cm  
240 cm

cm 80 cm 93  
Ø 25 mm  
cm 180/240  
spessore/thickness  
Ø 0,6 mm

# Asta doccia angolare

Corner shower rail  
 Barre angulaire de douche  
 Eckduschstange  
 Barra angular para cortinas  
 Угловые карнизы для душевой занавески

## TANG800



02

Bianco  
White

### Alluminio con laccatura epossidica e resine termoplastiche

Epoxy lacquered aluminium and thermoplastic resins  
 Aluminium laquage époxi et thermoplastique  
 Aluminium mit Epoxid-Beschichtung und Kunststoff  
 Aluminio pintado epoxi y resinas termoplásticas  
 Алюминий с эпоксидным покрытием и термопластичные смолы

13

Alluminio  
anodizzato  
Anodized  
aluminum

### Alluminio anodizzato e resine termoplastiche

Anodized aluminium and thermoplastic resins  
 Aluminium anodisé et thermoplastique  
 Eloxiertes Aluminium und Kunststoff  
 Aluminio anodizado y resinas termoplásticas  
 Анодированный алюминий и термопластичные смолы

Tenda consigliata:  
 Recommended shower curtain:  
 Rideau de douche recommandé:  
 Empfohlene duschvorhang:  
 Se recomienda cortina de ducha:  
 Рекомендуемая занавеска:

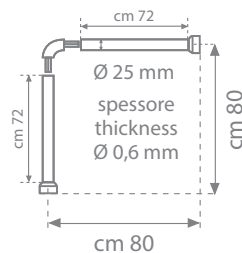

## TANG801



02

Bianco  
White

### Alluminio con laccatura epossidica e resine termoplastiche

Epoxy lacquered aluminium and thermoplastic resins  
 Aluminium laquage époxi et thermoplastique  
 Aluminium mit Epoxid-Beschichtung und Kunststoff  
 Aluminio pintado epoxi y resinas termoplásticas  
 Алюминий с эпоксидным покрытием и термопластичные смолы

13

Alluminio  
anodizzato  
Anodized  
aluminum

### Alluminio anodizzato e resine termoplastiche

Anodized aluminium and thermoplastic resins  
 Aluminium anodisé et thermoplastique  
 Eloxiertes Aluminium und Kunststoff  
 Aluminio anodizado y resinas termoplásticas  
 Анодированный алюминий и термопластичные смолы

Tenda consigliata:  
 Recommended shower curtain:  
 Rideau de douche recommandé:  
 Empfohlene duschvorhang:  
 Se recomienda cortina de ducha:  
 Рекомендуемая занавеска:

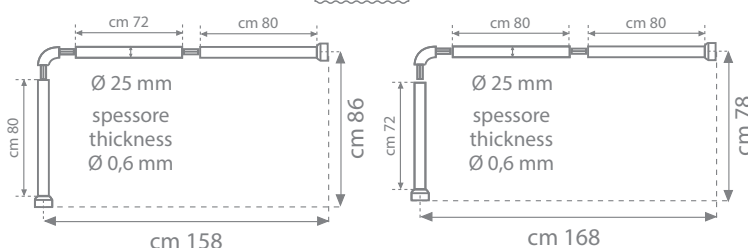

Tenda consigliata:  
 Recommended shower curtain:  
 Rideau de douche recommandé:  
 Empfohlene duschvorhang:  
 Se recomienda cortina de ducha:  
 Рекомендуемая занавеска:

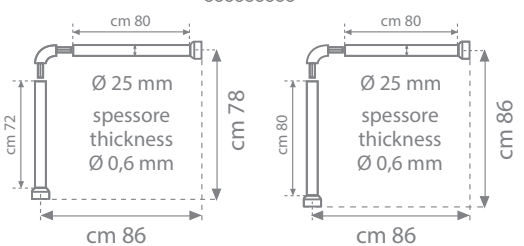



## TANG802



02

Bianco  
White**Alluminio con laccatura epossidica e resine termoplastiche**

Epoxy lacquered aluminium and thermoplastic resins  
 Aluminium laquage époxi et thermoplastique  
 Aluminium mit Epoxid-Beschichtung und Kunststoff  
 Aluminio pintado epoxy y resinas termoplásticas  
 Алюминий с эпоксидным покрытием и термопластичные смолы

13

Alluminio  
anodizzato  
Anodized  
aluminum**Alluminio anodizzato e resine termoplastiche**

Anodized aluminum and thermoplastic resins  
 Aluminium anodisé et thermoplastique  
 Eloxiertes Aluminium und Kunststoff  
 Aluminio anodizado y resinas termoplásticas  
 Анодированный алюминий и термопластичные смолы

Tenda consigliata:  
 Recommended  
 shower curtain:  
 Rideau de douche  
 recommandé:  
 Empfohlene  
 duschvorhang:  
 Se recomienda  
 cortina de ducha:  
 Рекомендуемая  
 занавеска:

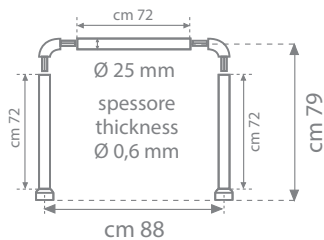

## TANG803



02

Bianco  
White**Alluminio con laccatura epossidica e resine termoplastiche**

Epoxy lacquered aluminium and thermoplastic resins  
 Aluminium laquage époxi et thermoplastique  
 Aluminium mit Epoxid-Beschichtung und Kunststoff  
 Aluminio pintado epoxy y resinas termoplásticas  
 Алюминий с эпоксидным покрытием и термопластичные смолы

13

Alluminio  
anodizzato  
Anodized  
aluminum**Alluminio anodizzato e resine termoplastiche**

Anodized aluminum and thermoplastic resins  
 Aluminium anodisé et thermoplastique  
 Eloxiertes Aluminium und Kunststoff  
 Aluminio anodizado y resinas termoplásticas  
 Анодированный алюминий и термопластичные смолы

Tenda consigliata:  
 Recommended  
 shower curtain:  
 Rideau de douche  
 recommandé:  
 Empfohlene  
 duschvorhang:  
 Se recomienda  
 cortina de ducha:  
 Рекомендуемая  
 занавеска:

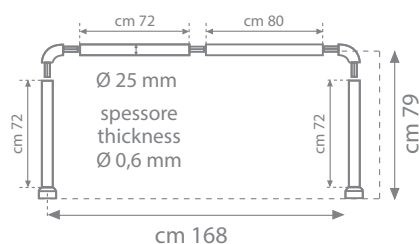
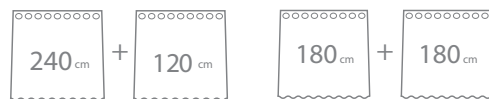

## TUNI900



02

Bianco  
White**Alluminio con laccatura epossidica e resine termoplastiche**

Epoxy lacquered aluminium and thermoplastic resins  
 Aluminium laquage époxi et thermoplastique  
 Aluminium mit Epoxid-Beschichtung und Kunststoff  
 Aluminio pintado epoxi y resinas termoplásticas  
 Алюминий с эпоксидным покрытием и термопластичные смолы



13

Alluminio  
anodizzato  
Anodized  
aluminum**Alluminio anodizzato e resine termoplastiche**

Anodized aluminum and thermoplastic resins  
 Aluminium anodisé et thermoplastique  
 Eloxiertes Aluminium und Kunststoff  
 Aluminio anodizado y resinas termoplásticas  
 Анодированный алюминий и термопластичные смолы



Tenda consigliata:  
Recommended shower curtain:  
Rideau de douche recommandé:  
Empfohlene duschvorhang:  
Se recomienda cortina de ducha:  
Рекомендуемая занавеска:

180 cm

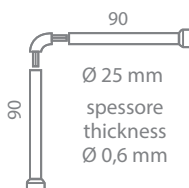

Tenda consigliata:  
Recommended shower curtain:  
Rideau de douche recommandé:  
Empfohlene duschvorhang:  
Se recomienda cortina de ducha:  
Рекомендуемая занавеска:

240 cm

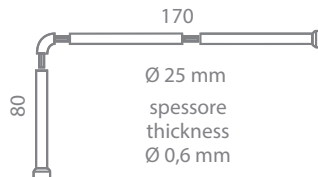

Tenda consigliata:  
Recommended shower curtain:  
Rideau de douche recommandé:  
Empfohlene duschvorhang:  
Se recomienda cortina de ducha:  
Рекомендуемая занавеска:

240 cm

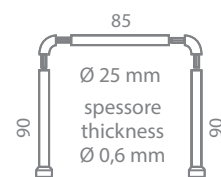

# SENSORIAL



# Tappeti in cotone

Cotton mats - Tapis en coton - Matten aus Baumwolle  
Alfombras de algodón - Хлопок



## G•BOMBAY

BO 5080

80 cm



50 cm

TRATTAMENTO ANTISCIVOLO SPRAY LATEX

ANTISLIP SPRAY LATEX BACKING

ENVERS ANTIGLISSANT

LATEXÉ SPRAY

MIT GLEITSCHUTZENDER SPRAY

LATEXBESCHICHTUNG

CON RECUBRIMIENTO DE LATEX SPRAY CONTRA RESBALÓN

С ЗАВОЛАКИВАНИЕМ СПРАЙ



04

Verde  
Green  
Vert  
Grün  
Verde  
Зелёный

11

Azzurro  
Light blue  
Bleu ciel  
Hellblau  
Azul celeste  
Голубой

67

Arancio  
Orange  
Anaranjado  
Оранжевый



1400 gr/mq



## G•BRAMANTE

96 6860

100 cm

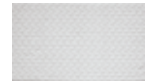

60 cm

TRATTAMENTO ANTISCIVOLO SPRAY LATEX

ANTISLIP SPRAY LATEX BACKING

ENVERS ANTIGLISSANT

LATEXÉ SPRAY

MIT GLEITSCHUTZENDER SPRAY

LATEXBESCHICHTUNG

CON RECUBRIMIENTO DE LATEX SPRAY CONTRA RESBALÓN

С ЗАВОЛАКИВАНИЕМ СПРАЙ

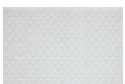

02

Bianco  
White  
Blanc  
Weiss  
Blanco  
Белый

03

Ecru  
Ekrü  
Беж



1440 gr/mq





## G•DELHI

DE 5080

81 cm



**REVERSIBILE**

REVERSIBLE - RÉVERSIBLE

WENDE-DESIGN - REVERSIBLE - РЕВЕРЗИБЕЛЬНО



**03**

Escri  
Escri  
Escri  
Ekrü  
Escri  
Темно

**36**

Nocciola  
Hazelnut  
Noisette  
Haselnussbraun  
Avellana  
Фундука цвет



## G•KLIMT

96 7340

96 7350

96 7360

60 cm



80 cm



100 cm



**FONDO IN LATEX**

LATEX BACKING - ENVERS LATEXÉ

LATEXBESCHICHTUNG - RECUBRIMIENTO DE LÁTEX

С ЛАТЕКОВЫМ НИЖНИМ СЛОЕМ

LATEX BACKING - ENVERS LATEXÉ

LATEXBESCHICHTUNG - RECUBRIMIENTO DE LÁTEX

С ЛАТЕКОВЫМ НИЖНИМ СЛОЕМ



**03**

Escri  
Ekrü  
Беж

**05**

Blu  
Blue  
Bleu  
Blau  
Azulón  
Синий

**08**

Grigio  
Grey  
Gris  
Grau  
Gris  
Серый

**29**

Moka  
Moka



## G•MANTEGNA

94 0170  
120 cm



**TRATTAMENTO ANTISCIVOLO SPRAY LATEX**  
**ANTISLIP SPRAY LATEX BACKING - ENVERS ANTIGLISSANT**  
**LATEXÉ SPRAY - MIT GLEITSCHUTZENDER SPRAY**  
**LATEXBESCHICHTUNG**  
**CON RECUBRIMIENTO DE LATEX SPRAY CONTRA RESBALÓN**  
**С ЗАВОЛАКИВАНИЕМ СПРАЙ**

57% poliestere - polyester - polyester - Polyester - poliester - полиэстер  
 43% cotone - cotton - coton - Baumwolle - algodón - хлопок



87  
Oro  
Gold  
Or  
Золото



## G•TINTORETTO

96 7240    96 7250    96 7260



**FONDO IN LATEX**  
**LATEX BACKING - ENVERS LATEXÉ - LATEXBESCHICHTUNG**  
**RECUBRIMIENTO DE LÁTEX - С ЛАТЕКСОВЫМ НИЖНИМ СЛОЕМ**  
**LATEX BACKING - ENVERS LATEXÉ**  
**LATEXBESCHICHTUNG - RECUBRIMIENTO DE LÁTEX**  
**С ЛАТЕКСОВЫМ НИЖНИМ СЛОЕМ**

25% poliestere - polyester - polyester - Polyester - poliester - полиэстер  
 75% cotone - cotton - coton - Baumwolle - algodón - хлопок



67  
Arancio  
Orange  
Anaranjado  
Оранжевый



76  
Fucsia  
Fuchsia  
Fuchsia  
Fucsia  
Фуксия





## G•TIZIANO

96 6550 96 6560 96 6570

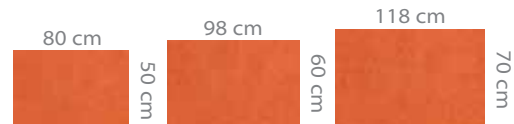

**TRATTAMENTO ANTISCIVOLO SPRAY LATEX**  
 ANTISLIP SPRAY LATEX BACKING - ENVERS ANTIGLISSANT  
 LATEXÉ SPRAY - MIT GLEITSCHUTZENDER SPRAY  
 LATEXBESCHICHTUNG  
 CON RECUBRIMIENTO DE LATEX SPRAY CONTRA RESBALÓN  
 С ЗАВОЛАКИВАНИЕМ СПРАЙ



**06**  
 Rosso  
 Red  
 Rouge  
 Rot  
 Rojo  
 Красный

**29**  
 Moka  
 Moka

**67**  
 Arancio  
 Orange  
 Anaranjado  
 Оранжевый

Escluso/  
 Without 966570



## G•UDAIPUR

UD 5080



**TRATTAMENTO ANTISCIVOLO SPRAY LATEX**  
 ANTISLIP SPRAY LATEX BACKING  
 ENVERS ANTIGLISSANT  
 LATEXÉ SPRAY - MIT GLEITSCHUTZENDER SPRAY  
 LATEXBESCHICHTUNG  
 CON RECUBRIMIENTO DE LATEX SPRAY CONTRA RESBALÓN  
 С ЗАВОЛАКИВАНИЕМ СПРАЙ



**49**  
 Bianco/Fucsia/Lilla  
 White/Fuchsia/Lilac  
 Blanc/Fuchsia/Lilas  
 Weiss/Fuchsia/Fieder  
 Blanco/Fucsia/Lila  
 Белый/Фуксия/  
 Сирень



**89**  
 Bianco/Blu/Verde  
 White/Blue/Green  
 Blanc/Bleu/Vert  
 Weiss/Blau/Grün  
 Blanco/Azulón/Verde  
 Белый/Голубой/Зелёный



**93**  
 Bianco/Arancio/Rosso  
 White/Orange/Red  
 Blanc/Orange/Rouge  
 Weiss/Orange/Rot  
 Blanco/Aranjado/Rojo  
 Белый/Оранжевый/  
 Красный

# Tappeti in microfibra

Microfiber mats - Tapis en microfibre - Matten aus Mikrofaser  
Alfombras de microfibra - Ковры из микрофибры



## G•DONATELLO

94 0240

94 0250

94 0260

60 cm



40 cm

80 cm



50 cm

100 cm



60 cm

### FONDO IN LATEX

LATEX BACKING - ENVERS LATEXÉ - LATEXBESCHICHTUNG  
RECUBRIMIENTO DE LÁTEX - С ЛАТЕКСОВЫМ НИЖНИМ СЛОЕМ

100% poliestere - polyester - polyester - Polyester - poliester - полиэстер



**08**  
Grigio  
Grey  
Gris  
Grau  
Gris  
Серый

Abbi cura del tuo corpo,  
è l'unico posto in cui devi vivere.

Take care of your body.  
It's the only place you have to live.

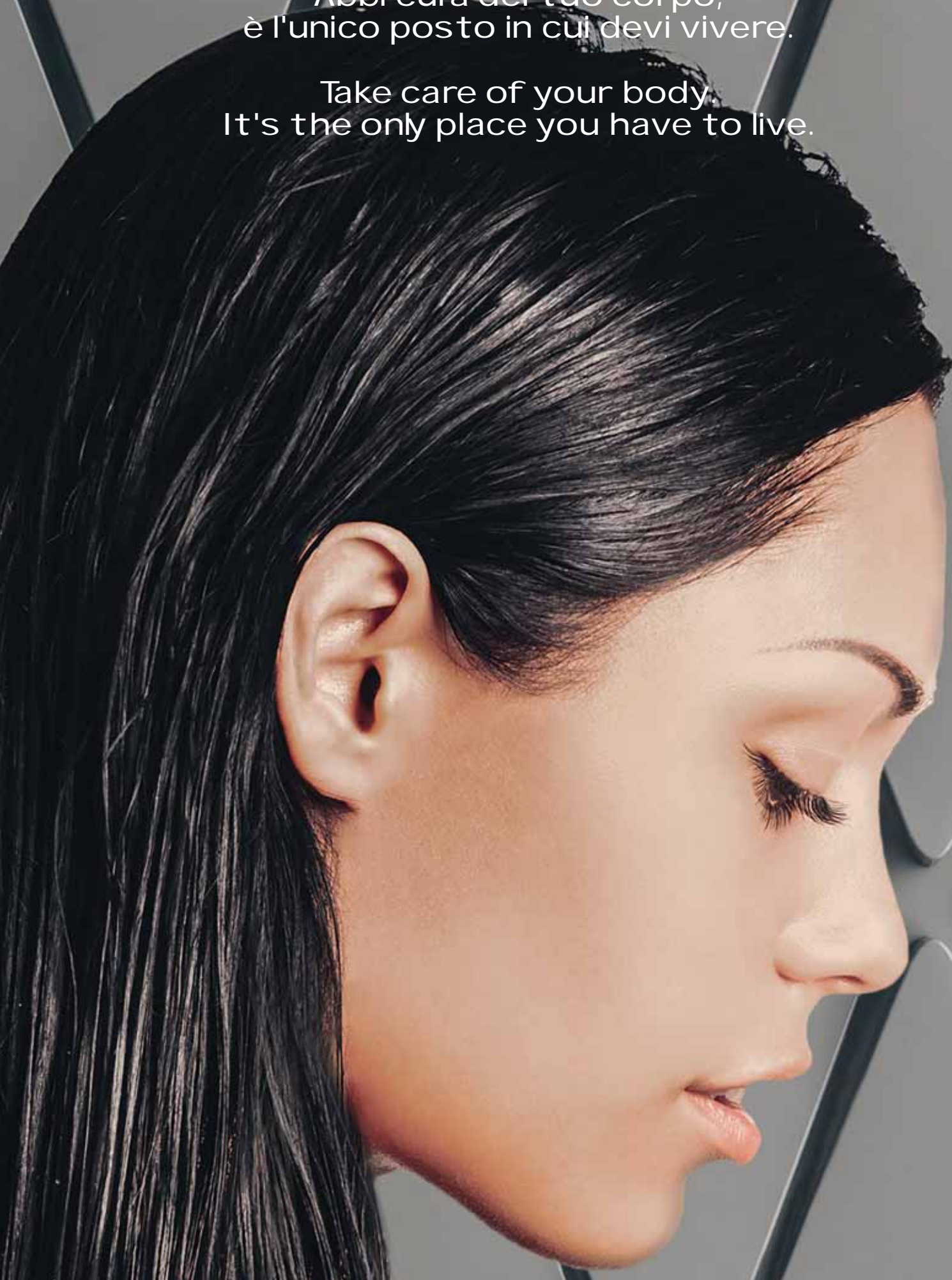



# Indice HYDROTHERAPY

hand shower	pagina 484
shower kit	pagina 499
shower set	pagina 508
shower column	pagina 521
shower panel	pagina 532
shower head	pagina 544
flex	pagina 548
accessories	pagina 551
hydraulics	pagina 561



# HYDROTHERAPY

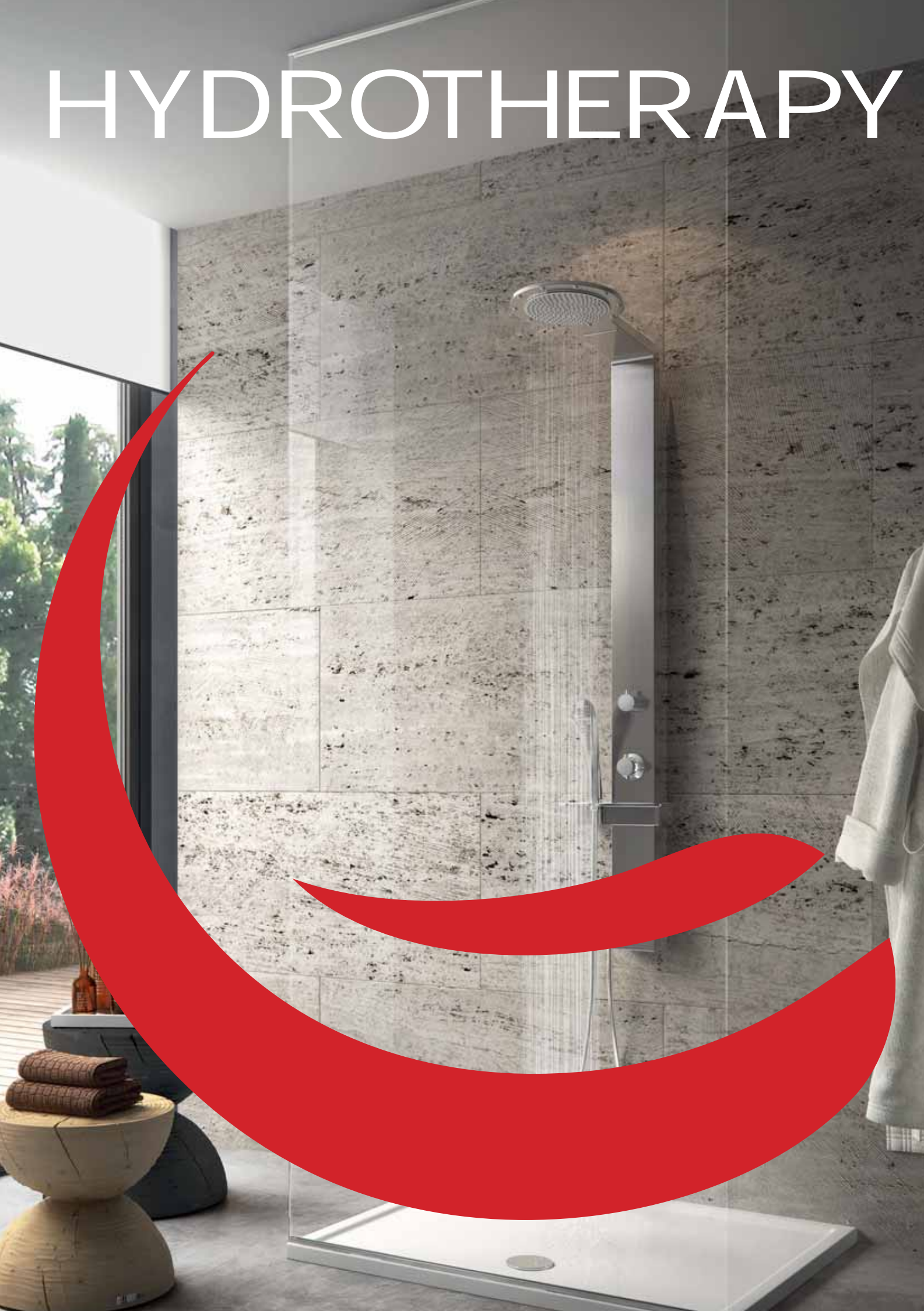

# G•HAND SHOWER

Le doccette Gedy sono presentate in una gamma ampia per design, numero di funzioni e prezzo.

Sono tutte dotate di filtro antisabbia, tettarelle che permettono una facile rimozione del calcare accumulatosi e di un filtro che permette la riduzione fino al 50% del consumo di acqua. Tutti gli attacchi sono nella misura universale standard 1/2".

Les douchettes Gedy sont présentées dans une vaste gamme subdivisée suivant le design, le nombre de fonctions et le prix. Elles sont toutes munies d'un filtre anti-sable, de pièces qui facilitent l'élimination du calcaire et d'un filtre qui permet de réduire jusqu'à 50% la consommation d'eau. Tous les raccords sont fournis dans la dimension universelle standard de 1/2 pouces.

Los mangos de ducha Gedy están disponibles en una amplia gama de modelos distintos por diseño, número de funciones y precio. Todos están dotados de filtro antiarena, eyectores que permiten una fácil remoción de la cal acumulada y de un filtro que permite reducir hasta el 50% el consumo de agua. Todas las conexiones son de tipo universal estándar de 1/2".

Gedy shower heads are available in a wide range of designs, function and prices.

All have sand filter, nipples for easy scale removal, and a filter to cut water consumption by up to 50%. All attachments are in the universal standard size of 1/2".

Die Handduschen Gedy werden hinsichtlich Design, Anzahl der Funktionen und Preis in einer großen Palette präsentiert. Alle ausgestattet mit Sandfilter, Einsatz für eine einfache Entfernung von Kalkablagerungen sowie Filter für die Verringerung des Wasserverbrauch um bis zu 50%. Alle Anschlüsse mit den Standard-Universalmaßen 1/2".

Ручные души Gedy представлены в широком ассортименте по дизайну, количеству функций и стоимости. Все они оснащены фильтром для задержки песка, легко чистящимися от скопившейся накипи соплами и регулятором расхода, позволяющим сэкономить до 50% воды. Все соединения универсальные, отвечающие стандарту 1/2".



Water Saving



Anticalcare  
Anti-limestone  
Anticalcaire  
Kesselsteinlösemittel  
Antical  
Защита от известкового налета



Pioggia  
Rain  
Pluie  
Regen  
Lluvia  
Дождик



Pioggia+Relax  
Rain+Relax  
Pluie+Détente  
Regen+Relax  
Lluvia+Relax  
Дождик+Релакс



Morbido  
Soft  
Moelleux  
Weich  
Suave  
Мягкая



Cascata  
Cascade  
Cascade eau  
Wasserfall  
Cascada  
Водопад



Sottile  
Thin  
Fin  
Leicht  
Fino  
Тонкая



Doppio relax  
Double relax  
Double détente  
Doppleter Relax  
Doble Relax  
Супер релакс



Nebulizzato  
Spray  
Nébulisé  
Zerstäubt  
Nebulizado  
Распыление



Acqua stop  
Water stop  
Arrêt eau  
Wasserstopp  
Agua stop  
Пульсация

Connessione  
**UNIVERSALE**  
Universal  
**CONNECTION**

col. 13

Cromato  
Chromed  
Chromé  
Chrom  
Cromado  
Хром



Realizzate in ABS  
Made of ABS  
Réalisés en ABS  
Hergestellt aus ABS  
Realizados en ABS  
Изготовлено из АБС пластик



G•BASIC



## G•BASIC 00

GYHS09000

Ø 6,7 x 6 x 20 cm

BIANCO/WHITE



## G•BASIC 01

GYHS09001

Ø 6,7 x 6 x 20 cm

CROMATO/CHROMED



G•EASY

## G•EASY 00

GYHS10000

Ø 6 x 5 x 18 cm

CROMATO/CHROMED



## G•EASY 02

GYHS10002

Ø 6,7 x 6 x 20 cm

CROMATO/CHROMED



## G•EASY 03

GYHS10003

Ø 6,7 x 6 x 20 cm

BIANCO/WHITE



# G•EASY

## G•EASY O4

GYHS10004

Ø 6,7 x 6 x 20 cm

NERO/BLACK



RAIN

## G•EASY O5

GYHS10005

Ø 7,6 x 5 x 20 cm

CROMATO/CHROMED



RAIN

## G•EASY O6

GYHS10006

Ø 8,4 x 6,5 x 19,5 cm

CROMATO/CHROMED



RAIN



SOFT



TONIC



RAIN+SOFT

# G•HAND SHOWER

## G•TRENDY

### G•TRENDY O0

GYHS10100

Ø 3 x 21 cm

CROMATO/CHROMED



### G•TRENDY O1

GYHS10101

Ø 6,5 x 5 x 21,5 cm

CROMATO/CHROMED



### G•TRENDY O2

GYHS10102

Ø 4,3 x 3,9 x 22,8 cm

CROMATO/CHROMED



### G•TRENDY O3

GYHS10103

Ø 6,8 x 9,3 x 23 cm

CROMATO/CHROMED



# G•STAR

## G•STAR 00

GYHS10200

Ø 8 x 5 x 22 cm

CROMATO/CHROMED



## G•STAR 01

GYHS10201

Ø 8 x 5 x 22 cm

CROMATO/CHROMED



## G•STAR 04

GYHS10204

Ø 10 x 3 x 24,5 cm

CROMATO/CHROMED



## G•STAR 05

GGYHS10205

Ø 10 x 3 x 24,5 cm

CROMATO/CHROMED



# G•HAND SHOWER

## G•TECH

### G•TECH 00

GYHS10300

Ø 12 x 4 x 25 cm

CROMATO/CHROMED



RAIN

### G•TECH 01

GYHS10301

Ø 12 x 4 x 25 cm

CROMATO/BIANCO  
CHROMED/WHITE



RAIN



TONIC



RAIN+TONIC

### G•TECH 02

GYHS10302

Ø 12 x 4 x 25 cm

CROMATO/CHROMED



RAIN



TONIC



RAIN+TONIC

### G•TECH 03

GYHS10303

Ø 12 x 4 x 25 cm

NICHEL SPAZZOLATO  
BRUSHED NICKEL



RAIN



TONIC



RAIN+TONIC

### G•TECH 04

GYHS10304

Ø 11,5 x 6 x 25 cm

CROMATO/CHROMED



RAIN

### G•TECH 05

GYHS10305

Ø 11,5 x 6 x 25 cm

CROMATO/CHROMED



RAIN



TONIC



RAIN+TONIC



# G•TECH

## G•TECH 06

GYHS10306

Ø 11,5 x 6 x 25 cm

CROMATO/CHROMED



5  
JETS



RAIN



TONIC



MASSAGE



RAIN+TONIC



RAIN+MASSAGE

## G•TECH 07

GYHS10307

Ø 12 x 3,5 x 25,5 cm

CROMATO/CHROMED



3  
JETS



RAIN



TONIC



RAIN+TONIC

## G•TECH 08

GYHS10308

Ø 10,5 x 5, x 24,5 cm

CROMATO/CHROMED



3  
JETS



RAIN



CASCADE



AQUA STOP

## G•TECH 10

GYHS10310

Ø 8 x 5 x 27 cm

CROMATO/CHROMED



3  
JETS



RAIN



MASSAGE



RAIN+MASSAGE

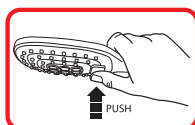

PUSH SYSTEM JETS CHANGE  
CAMBIO GETTI A PULSANTE

## G•TECH 11

GYHS10311

Ø 12 x 3,5 x 26,5 cm

CROMATO/CHROMED



3  
JETS



RAIN



MASSAGE



RAIN+MASSAGE

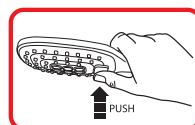

PUSH SYSTEM JETS CHANGE  
CAMBIO GETTI A PULSANTE

## G•TECH 12

GYHS10312

Ø 12 x 4 x 25 cm

CROMATO/CHROMED



3  
JETS



RAIN



TONIC



RAIN+TONIC

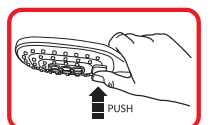

PUSH SYSTEM JETS CHANGE  
CAMBIO GETTI A PULSANTE

# G•HAND SHOWER



# G•TOP

## G•TOP 00

GYHS10400

Ø 12 x 6 x 26 cm

CROMATO/CHROMED



RAIN



TONIC



MASSAGE



RAIN+TONIC



RAIN+MASSAGE

## G•TOP 01

GYHS10401

Ø 15 x 5,5 x 29 cm

CROMATO/CHROMED



RAIN



TONIC



SOFT



CASCADE



AQUA STOP

## G•HAND SHOWER

## G•TENDENCE

## G•TENDENCE 00

GYHS10500

Ø 13,5 x 3 x 26,5 cm

CROMATO/BIANCO  
CHROMED/WHITE

RAIN



MASSAGE

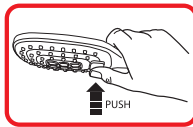

RAIN+MASSAGE

PUSH SYSTEM JETS CHANGE  
CAMBIO GETTI A PULSANTE

## G•TENDENCE 01

GYHS10501

Ø 13,5 x 3 x 26,5 cm

CROMATO/NERO  
CHROMED/BLACK

RAIN



MASSAGE

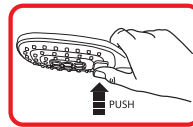

RAIN+MASSAGE

PUSH SYSTEM JETS CHANGE  
CAMBIO GETTI A PULSANTE

## G•TENDENCE 02

GYHS10502

Ø 6 x 4 x 25 cm

CROMATO/BIANCO  
CHROMED/WHITE

RAIN

## G•TENDENCE 03

GYHS10503

Ø 6 x 4 x 25 cm

CROMATO/NERO  
CHROMED/BLACK

RAIN

## G•TENDENCE 06

GYHS10506

Ø 10,5 x 3 x 25,5 cm

BIANCO/WHITE



RAIN

## G•TENDENCE 07

GYHS10507

Ø 10,5 x 3 x 25,5 cm

NERO /BLACK



RAIN

# G•TENDENCE

## G•TENDENCE 08

GYHS10508

Ø 10 x 4 x 26 cm

CROMATO/BIANCO  
CHROMED/WHITE

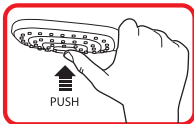

**ANTH-LIMESTONE PUSH SYSTEM**  
**PULIZIA CALCARE A PULSANTE**

## G•TENDENCE 10

GYHS10510

Ø 10 x 4 x 26 cm

CROMATO/BIANCO  
CHROMED/WHITE

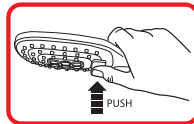

**PUSH SYSTEM JETS CHANGE**  
**CAMBIO GETTI A PULSANTE**

# G•HAND SHOWER

## G•LIBERTY

### G•LIBERTY O0

GYHS10600

Ø 9 x 8,7 x 24 cm

CROMATO/CHROMED



### G•LIBERTY O1

GYHS10601

Ø 9 x 8,7 x 24 cm

BRONZO/BRONZE



### G•LIBERTY O2

GYHS10602

Ø 9 x 8,7 x 24 cm

RAME/ COPPER





# G•LIGHT - THERMO LIGHT - THERMO

## G•LIGHT O0

GYHS10700  
 Ø 10 x 6,4 x 25 cm  
 CROMATO/CHROMED



3  
 JETS



RAIN



TONIC



RAIN+TONIC

3  
 COLOR CHANGE

## G•LIGHT O1

GYHS10701  
 Ø 10 x 6,4 x 25 cm  
 BIANCO/WHITE



3  
 JETS



RAIN



TONIC



RAIN+TONIC

3  
 COLOR CHANGE

## G•LIGHT O3

GYHS10703  
 Ø 10,9 x 7,9 x 24,2 cm  
 CROMATO/CHROMED



1  
 JET



RAIN

7  
 COLOR CHANGE

## G•LIGHT O6

GYHS10706  
 Ø 11,3 x 10,5 x 25 cm  
 CROMATO/CHROMED



3  
 JETS



RAIN



TONIC



RAIN+TONIC

7  
 COLOR CHANGE

## G•LIGHT O9

GYHS10709  
 Ø 11,3 x 10,5 x 25 cm  
 CROMATO/CHROMED



3  
 JETS



RAIN



TONIC



RAIN+TONIC

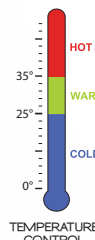

3  
 COLOR CHANGE

## G•THERMO LIGHT O0

GYHS10800  
 Ø 12,1 x 4,3 x 24 cm  
 CROMATO/CHROMED



1  
 JET



RAIN

36°

TEMPERATURE CHECK POINT

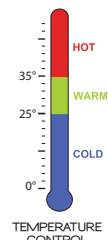

3  
 COLOR CHANGE

# G•HAND SHOWER



# G•LIGHT - THERMO LIGHT - THERMO

## G•THERMO LIGHT O1

GYHS10801  
 Ø 12,1 x 4,3 x 24 cm  
 BIANCO/WHITE

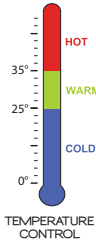

## G•THERMO OO

GYHS10900  
 Ø 11,9 x 6,2 x 26 cm  
 CROMATO/CHROMED



## G•MUSIC OO

GYHS11100  
 Ø 12,5 x 4 x 25 cm  
 CROMATO/BIANCO  
 CHROMED/WHITE



## G•THERMO LIGHT O2

GYHS10802  
 Ø 12,1 x 4,3 x 24 cm  
 NERO/BLACK

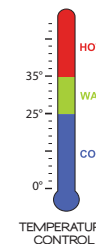

## G•THERMO O1

GYHS10901  
 Ø 11,9 x 6,2 x 26 cm  
 BIANCO/WHITE



# G•SHOWER KIT

Alcune doccette della nostra gamma vengono presentate in una pratica confezione per il consumatore che include un flessibile in acciaio inox da cm.150 e un supporto a parete.

Certaines douchettes de notre gamme sont présentées dans un emballage pratique pour le consommateur, avec un tuyau flexible en acier inox de 150 cm et un support mural.

Igunos mangos de ducha de nuestra gama están contenidos dentro de una caja muy práctica para el consumidor que incluye un flexo de acero inoxidable de 150 cm y un soporte de pared.

Some shower heads in our range are sold in a practical package for the customer, which includes a 150 cm stainless steel hose plus a wall bracket.

Einige Handduschen unserer Produktpalette werden in einer praktischen Konfektion für den Verbraucher präsentiert, die einen Schlauch aus Edelstahl zu 150 cm sowie eine Wandhalterung umfasst.

Некоторые ручные души нашей коллекции представлены в виде практично упакованных комплектов, включающих шланг из нержавеющей стали на 150 см. и настенное крепление.



ConneSSIONE  
**UNIVERSALE**  
Universal  
**CONNECTION**

col. 13  
Cromato  
Chromed  
Chromé  
Cromado  
Хром

Realizzati in ABS, acciaio inox e ottone  
Made of ABS, stainless steel and brass  
Réalisés en ABS, acier inoxydable and laiton  
Hergestellt aus ABS, Edelstahl und Messing  
Realizados en ABS, acero inox y latón  
Изготовлено из АБС,  
нержавеющей стали и латуны

# G•EASY



## G•EASY O0

GYSK10000

CROMATO/CHROMED



1  
JET



## G•EASY O2

GYSK10002

CROMATO/CHROMED



1  
JET



## G•EASY O5

GYSK10005

CROMATO/CHROMED



1  
JET



## G•EASY O6

GYSK10006

CROMATO/CHROMED



4  
JETS



# G•SHOWER KIT

## G•TRENDY

### G•TRENDY O0

GYSK10100

CROMATO/CHROMED



### G•TRENDY O1

GYSK10101

CROMATO/CHROMED



### G•TRENDY O2

GYSK10102

CROMATO/CHROMED



### G•TRENDY O3

GYSK10103

CROMATO/CHROMED





# G•STAR

## G•STAR O0

GYSK10200

CROMATO/CHROMED



## G•STAR O1

GYSK10201

CROMATO/CHROMED



## G•STAR O4

GYSK10204

CROMATO/CHROMED



## G•STAR O5

GYSK10205

CROMATO/CHROMED



# G•SHOWER KIT



# G•TECH

## G•TECH 00

GYSK10300

CROMATO/CHROMED



## G•TECH 02

GYSK10302

CROMATO/CHROMED



## G•TECH 03

GYSK10303

NICHEL SPAZZOLATO  
BRUSHED NICKEL



## G•TECH 05

GYSK10305

CROMATO/CHROMED



## G•TECH 06

GYSK10306

CROMATO/CHROMED



## G•TECH 08

GYSK10308

CROMATO/CHROMED



# G•SHOWER KIT

G•TOP

## G•TOP 00

GYSK10400

CROMATO/CHROMED



RAIN



TONIC



MASSAGE



RAIN+TONIC



RAIN+MASSAGE

## G•TOP 01

GYSK10401

CROMATO/CHROMED



RAIN



TONIC



SOFT



CASCADE



AQUA STOP

# G•TENDENCE

## G•TENDENCE O2

GYSK10502

CROMATO/BIANCO  
CHROMED/WHITE



RAIN

## G•TENDENCE O3

GYSK10503

CROMATO/NERO  
CHROMED/BLACK



RAIN

## G•TENDENCE O6

GYSK10506

BIANCO/WHITE



RAIN

## G•TENDENCE O7

GYSK10507

NERO/BLACK



RAIN

# G•SHOWER KIT

## G•LIBERTY

### G•LIBERTY O0

GYSK10600

CROMATO/CHROMED



### G•LIBERTY O1

GYSK10601

BRONZO/BRONZE



### G•LIBERTY O2

GYSK10602

RAME/ COPPER



# G•SPEEDY

### G•SPEEDY

GYSK99000

CROMATO/CHROMED



# G•MUSIC

### G•MUSIC O0

GYSK11100

CROMATO-BIANCO/  
WHITE-CHROMED





# G•SHOWER SET

A completamento della gamma doccette, Gedy propone anche la versione saliscendi, anche con interasse variabile del supporto a muro in modo da coprire fori a parete preesistenti, completa di flessibile in acciaio inox da cm.150 e di un porta sapone/porta oggetti. Disponibili anche una versione senza portasapone e la sola barra con saliscendi di ricambio.

Pour compléter la gamme des douchettes, Gedy propose également la version avec une barre de douche, munie d'un entraxe variable du support mural de manière à couvrir les trous préexistants dans le mur, et un tuyau flexible en acier inox de 150 cm et un porte-savon/porte-objets. On propose également une version sans porte-savon, comprenant uniquement la barre avec un dispositif de coulissement de rechange.

Para completar la gama de mangos de ducha, Gedy propone también la versión con soporte deslizante, también con distancia entre ejes variable del soporte de pared para tapar los agujeros ya existentes en la pared, completa de flexo de acero inoxidable de 150 cm y de una jabonera/porta-objetos. Disponible también una versión sin jabonera y solo la barra con soporte deslizante de repuesto.

To complete the range of shower heads, Gedy also offers the sliding bar version, with a variable fastening distance so as to cover existing holes in the wall and complete with 150 cm flexible hose and a soap/object dish. Also available without soap dish and with spare sliding bar.

Zur Vervollständigung der Handduschenpalette bietet Gedy auch die Version mit Wandschiene an, auch mit variablem Abstand der Wandhalterung zur Abdeckung der in der Wand vorhandenen Bohrungen, vollständig mit Schlauch aus Edelstahl zu 150 cm und Seifenhalter/Ablage. Auch verfügbar in einer Version ohne Seifenhalter und nur Ersatz-Wandschiene.

Для дополнения коллекции душей компания Gedy предлагает также исполнение со штангой, в том числе с подвижным настенным креплением, позволяющим скрыть существующие на стене отверстия, в комплекте со шлангом из нержавеющей стали на 150 см. и мыльницей/полочкой. Возможен вариант штанги со сменными держателями без мыльницы.



Connessione  
**UNIVERSALE**  
Universal  
**CONNECTION**

col. 13  
Cromato  
Chromed  
Chromé  
Chrom  
Хром

Realizzati in ABS e acciaio inox  
Made of ABS and stainless steel  
Réalisés en ABS et acier inoxydable  
Hergestellt aus ABS und Edelstahl  
Realizados en ABS y acero inox  
Изготовлено из АБС  
и нержавеющей сталь



# G•EASY

## G•EASY O2

GYSS10002

LUCIDO/POLISHED



## G•EASY O5

GYSS10005

LUCIDO/POLISHED



## G•EASY O6

GYSS10006

LUCIDO/POLISHED



# G•TRENDY

## G•TRENDY O0

GYSS10100

LUCIDO/POLISHED



## G•TRENDY O1

GYSS10101

LUCIDO/POLISHED



**G•TRENDY O2**

GYSS10102

CROMATO/CHROMED

**G•TRENDY O3**

GYSS10103

CROMATO - CHROMED



# G•STAR

## G•STAR O1

GYSS10201

CROMATO/CHROMED



## G•STAR O4

GYSS10204

CROMATO/CHROMED



## G•STAR O5

GYSS10205

CROMATO/CHROMED



# G•SHOWER SET



**G•TECH O0**                      **G•TECH O1**                      **G•TECH O2**

GYSS10300

GYSS10301

GYSS10302

CROMATO/CHROMED

CROMATO/BIANCO  
CHROMED/WHITE

CROMATO/CHROMED



RAIN



RAIN



TONIC



RAIN+TONIC



RAIN



TONIC



RAIN+TONIC



# G•TECH

## G•TECH 03

GYSS10303

NICHEL SPAZZOLATO  
BRUSHED NICKEL



3  
JETS



RAIN



TONIC



RAIN+TONIC

## G•TECH 05

GYSS10305

CROMATO/CHROMED



3  
JETS



RAIN



TONIC



RAIN+TONIC

## G•TECH 06

GYSS10306

CROMATO/CHROMED



5  
JETS



RAIN



TONIC



MASSAGE



RAIN+TONIC



RAIN+MASSAGE

# G•SHOWER SET

## G•TECH 08

GYSS10308

CROMATO/CHROMED



RAIN



CASCADE



AQUA STOP

## G•TECH 10

GYSS10310

CROMATO/CHROMED



RAIN



MASSAGE



RAIN+MASSAGE

## G•TECH 11

GYSS10311

CROMATO/CHROMED



RAIN



MASSAGE



RAIN+MASSAGE

# G•TOP

## G•TOP 00

GYSS10400

CROMATO/CHROMED



5  
JETS



RAIN



TONIC



MASSAGE



RAIN+TONIC



RAIN+MASSAGE

## G•TOP 01

GYSS10401

CROMATO/CHROMED



5  
JETS



RAIN



TONIC



SOFT



CASCADE



AQUA STOP

# G•SHOWER SET

# G•TENDENCE

## G•TENDENCE 00

GYSS10500

CROMATO/BIANCO  
CHROMED/WHITE



## G•TENDENCE 01

GYSS10501

CROMATO/NERO  
CHROMED/BLACK



# G•TENDENCE

## G•TENDENCE O2

GYSS10502

CROMATO/BIANCO  
CHROMED/WHITE



## G•TENDENCE O3

GYSS10503

CROMATO/NERO  
CHROMED/BLACK



# G•SHOWER SET

## G•TENDENCE O6

GYSS10506

CROMATO/BIANCO  
CHROMED/WHITE



## G•TENDENCE O7

GYSS10507

CROMATO/NERO  
CHROMED/BLACK





# G•LIBERTY

## G•LIBERTY 00

GYSS10600

CROMATO/CHROMED



## G•LIBERTY 01

GYSS10601

BRONZO/BRONZE



## G•LIBERTY 02

GYSS10602

RAME/COPPER



# G•SHOWER COLUMN

Una gamma compatta che va incontro a tutti i gusti e alle funzioni richieste nella doccia, racchiuse in un solo articolo compatto e dalle giuste proporzioni. Tutte le colonne sono regolabili in altezza per il massimo confort nella doccia per tutti i membri della famiglia.

Une gamme compacte qui satisfait tous les goûts et les fonctions d'une douche, réunies en un seul article compact et bien proportionné. Toutes les colonnes sont réglables en hauteur assurant le plus grand confort à l'intérieur de la douche à tous les membres de la famille.

Una gama compacta que satisface todos los gustos y las funciones requeridas para la ducha, unidas en un sólo artículo compacto y de proporciones adecuadas. Todas las barras para la ducha son regulables en altura para el máximo confort en la ducha de todos los miembros de la familia.

A compact range to satisfy all tastes and all of the functions required of a shower, in a single, compact and perfectly sized item. All columns are height adjustable for maximum shower comfort for all members of the family.

Eine kompakte, trendige Produktpalette, die alle Funktionen einer Dusche erfüllt, und dies in einem einzigen kompakten Artikel mit den richtigen Proportionen. Alle Duschsäulen sind höhenverstellbar, um allen Mitgliedern der Familie in der Dusche den optimalen Komfort zu bieten.

Эта компактная линейка душей отвечает всем требованиям и вкусам, объединенными в одном предмете оптимальных размеров.

Все души-колонны регулируются по высоте, что обеспечивает максимальный комфорт в душе для всех членов семьи.



Filtro Antisabbia  
Sand filter  
Filtre anti-sable  
Sandschutzfilter  
Filtro antirena  
Универсальное крепление



Anticalcare  
Anti-limestone  
Anticalcaire  
Kesselsteinlösemittel  
Antical  
Защита от известкового налета



Pioggia  
Rain  
Pluie  
Regen  
Lluvia  
Дождик



Sottile  
Thin  
Fin  
Leicht  
Fino  
Тонкая



Doppio relax  
Double relax  
Double détente  
Doppleter Relax  
Doble Relax  
Супер релакс

Conessione  
**UNIVERSALE**  
Universal  
**CONNECTION**

Realizzati in acciaio inox e ABS  
Made of stainless steel and ABS  
Réalisés en acier inoxydable et ABS  
Hergestellt aus Edelstahl und ABS  
Realizados en acero inox y ABS  
Изготовлено из нержавеющей стали и ABS

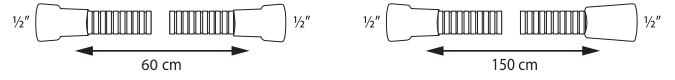

# G•EASY

- 
- 
- 
- 
- 
- 
- 
- 
- 

## G•EASY 00

GYSC10000  
20 x 41 x 100 cm  
CROMATO/CHROMED



1  
JET



RAIN

5  
JETS



RAIN



TONIC



SOFT



RAIN+TONIC



RAIN+SOFT

## G•EASY 01

GYSC10001  
23 x 46 x 100 cm  
CROMATO/BIANCO  
CHROMED/WHITE



1  
JET



RAIN

3  
JETS



RAIN



TONIC



RAIN+TONIC

## G•EASY O2

GYSC10002

20 x 39 x 104 cm

CROMATO/CHROMED



1  
JET



RAIN

5  
JETS



RAIN



TONIC



SOFT



RAIN+TONIC



RAIN+SOFT

## G•EASY O3

GYSC10003

20 x 44,5 x 100 cm

CROMATO/CHROMED



1  
JET



RAIN

1  
JET



RAIN



# G•SHOWER COLUMN

## G•EASY

### G•EASY O4

GYSC10004

23 x 46 x 100 cm

CROMATO/CHROMED



### G•EASY MIX O1

GYSC10101

20 x 39 x 100 cm

CROMATO/CHROMED





# G•EASY

## G•EASY MIX O2

GYSC10102

23 x 46 x 100 cm

CROMATO/CHROMED



RAIN+TONIC

# G•SHOWER COLUMN

## G•STAR

### G•STAR 00

GYSC10200

28 x 52 x 80/120 cm

CROMATO/CHROMED



### G•STAR 01

GYSC10201

20 x 49 x 106 cm

CROMATO/CHROMED



# G•STAR

## G•STAR MIX 00

GYSC10300  
28 x 52 x 80/120 cm  
CROMATO/CHROMED



## G•STAR MIX 01

GYSC10301  
26 x 54,5 x 98,5/133,5 cm  
CROMATO/CHROMED



# G•SHOWER COLUMN

## G•LIBERTY

### G•LIBERTY 00

GYSC10600

20 x 43 x 105 cm

CROMATO/CHROMED



### G•LIBERTY 01

GYSC10601

20 x 42 x 100 cm

BRONZO/BRONZE



### G•LIBERTY 02

GYSC10602

20 x 42 x 100 cm

RAME/COPPER





# G•SHOWER COLUMN

## G•LIGHT

## G•MUSIC

### G•LIGHT OO

GYSC10800  
20 x 45 x 100 cm  
CROMATO/CHROMED

### G•MUSIC OO

GYSC10900  
23 x 51 x 91 cm  
CROMATO-BIANCO/  
WHITE-CHROMED



BLUETOOTH



# G•SHOWER PANEL

A lato dei moderni pannelli in acciaio inox in finitura spazzolata, Gedy presenta anche una collezione di pannelli doccia multifunzione in vetro temperato ultralight laccato in colorazioni abbinabili con la sua enorme gamma di accessori e complementi per il bagno.

Outre les panneaux modernes en acier inox dans la finition brossée, Gedy présente une collection de panneaux de douche multifonction en verre trempé ultralight laqué dans des couleurs à assortir à sa gamme considérable d'accessoires et d'éléments de décoration pour la salle de bains.

Además de los modernos paneles de acero inoxidable con acabado cepillado, Gedy presenta también una colección de paneles ducha multifunción de vidrio templado ultralight laqueado en colores combinables con su enorme gama de accesorios y complementos para el baño.

Alongside the modern panels in stainless steel with brushed finish, Gedy also has a collection of multipurpose shower panels in ultralight tempered glass, which combine with its enormous range of accessories and complementary features for the bathroom.

Neben den moderne Paneelen aus gebürstetem Edelstahl bietet Gedy auch eine Kollektion von Multifunktionsduschpaneelen aus utraleichem gehärtetem Glas an, lackiert in Farben, die mit der enormen Palette der Accessoires für das Bad kombiniert werden kann.

Наряду с душевыми панелями из нержавеющей стали с отделкой «эффект щетки» Gedy представляет также коллекцию душевых многофункциональных панелей из суперлегкого закаленного стекла, покрытого цветным лаком, который можно сочетать с множеством аксессуаров и дополнений для ванной.



Pioggia  
Rain  
Pluie  
Regen  
Lluvia  
Дождик



Idromassaggio  
Massage jet  
Jet de massage  
Massagestrahl  
Chorro masaje  
массажная струя



Morbido  
Soft  
Moelleux  
Weich  
Suave  
Мягкая



Doppio relax  
Double relax  
Double détente  
Doppleter Relax  
Doble Relax  
Супер релакс





## G•STYLE OO

GYSP10000

20 x 41 x 130 cm

Argento  
Silver  
Argent  
Silber  
Plata  
серебро



## G•STYLE O1

GYSP10001

20 x 41 x 130 cm

Bianco  
White  
Blanc  
Weiss  
Blanco  
белый

### Miscelatore manuale

Manual mixer  
Mitigeur manuel  
Manueller Mischer  
Mezclador manual  
Ручной миксер

Vetro temperato  
Tempered glass  
Verre tempéré  
Sekuritglas  
Cristal templado  
закаленное стекло

### ABS/Acciaio inox/Ottone/Vetro

ABS/Stainless steel/Brass/Glass  
ABS/Acier inox/Laiton/Verre  
ABS/Edelstahl/Messing/Glas  
ABS/Acero inox/Latón/Vidrio  
АБС/Нержавеющая сталь/  
Латунь/Стекло

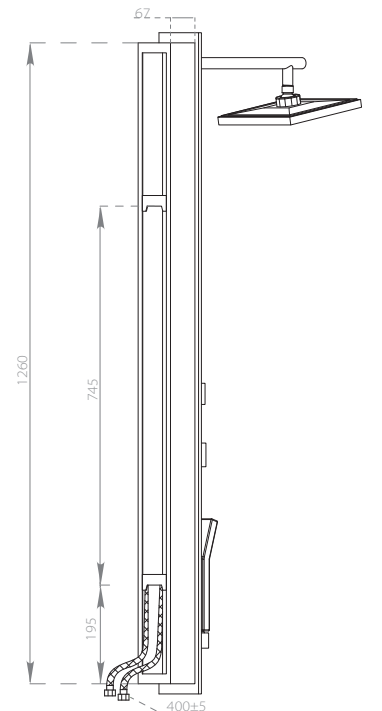
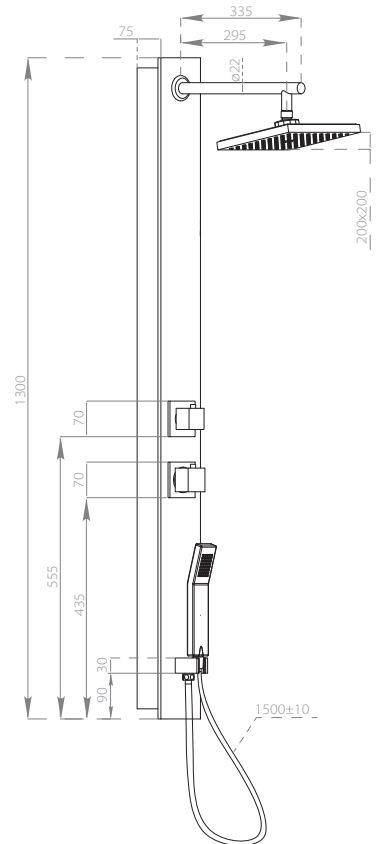

# G•SHOWER PANEL

Argento  
Silver  
Argent  
Silber  
Plata  
серебро

## G•STYLE PLUS OO

GYSP10100

20 x 41 x 130 cm



Miscelatore termostatico  
Thermostatic mixer  
Mitigeur thermostatique  
Thermostatmischer  
Mezclador termostático  
Термостатический смеситель

Vetro temperato  
Tempered glass  
Verre tempéré  
Sekuritglas  
Cristal templado  
закаленное стекло

ABS/Acciaio inox/Ottone/Vetro  
ABS/Stainless steel/Brass/Glass  
ABS/Acier inox/Laiton/Verre  
ABS/Edelstahl/Messing/Glas  
ABS/Acero inox/Latón/Vidrio  
АБС/Нержавеющая сталь/  
Латунь/Стекло

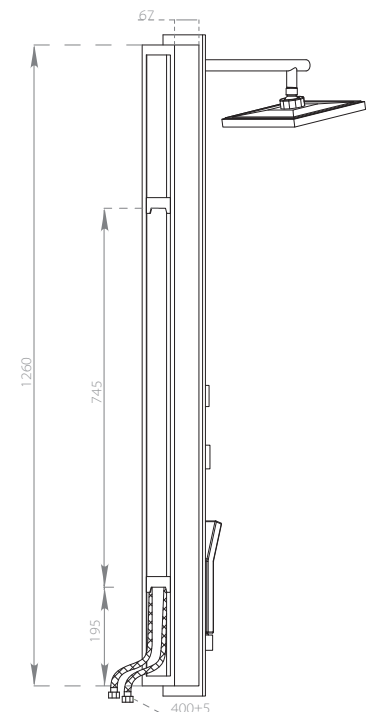
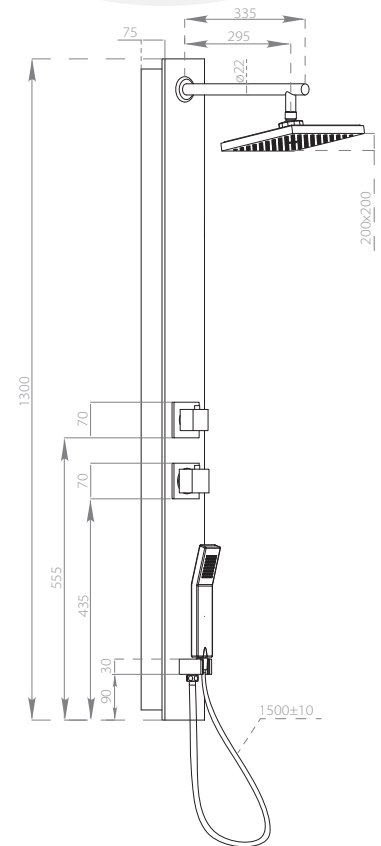



# G•SHOWER PANEL

**Inox spazzolato**  
 Brushed stainless steel  
 Acier inoxydable brossé  
 Edelstahl gebürstet  
 Acero inoxidable cepillado  
 Матовая нержавеющая сталь

## G•CASCADE OO

**GYSP10200**

17,5 x 50,5 x 154 cm

Miscelatore manuale  
 Manual mixer  
 Mitigeur manuel  
 Manueller Mischer  
 Mezclador manual  
 Ручной миксер



## G•CASCADE PLUS OO

**GYSP10300**

17,5 x 50,5 x 154 cm

Miscelatore termostatico  
 Thermostatic mixer  
 Mitigeur thermostatique  
 Thermostatmischer  
 Mezclador termostático  
 Термостатический смеситель



ABS/Acciaio inox/Ottone  
 ABS/Stainless steel/Brass  
 ABS/Acier inox/Laiton  
 ABS/Edelstahl/Messing  
 ABS/Acero inox/Latón  
 ABS/Нержавеющая сталь/Латунь

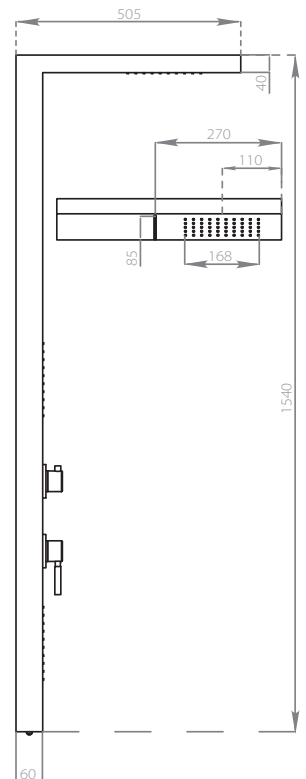
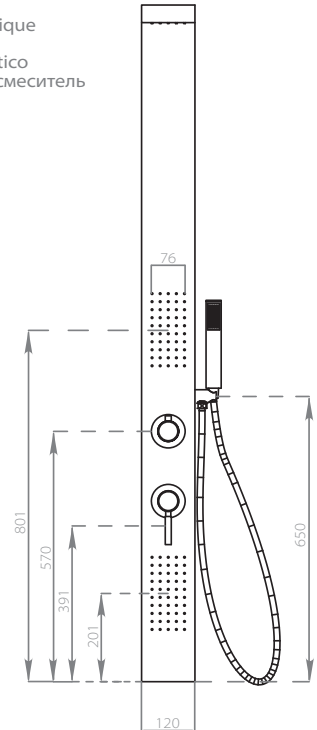





# G•SHOWER PANEL

**Inox spazzolato**  
 Brushed stainless steel  
 Acier inoxydable brossé  
 Edelstahl gebürstet  
 Acero inoxidable cepillado  
 Матовая нержавеющая сталь

## G•MESSAGE O1

GYSP10401

20,7 x 47,5 x 161 cm



WELLNESS



RAIN

**Miscelatore manuale**  
 Manual mixer  
 Mitigeur manuel  
 Manueller Mischer  
 Mezclador manual  
 Ручной миксер

**ABS/Acciaio inox/Ottone**  
 ABS/Stainless steel/Brass  
 ABS/Acier inox/Laiton  
 ABS/Edelstahl/Messing  
 ABS/Acero inox/Latón  
 АБС/Нержавеющая сталь/Латунь

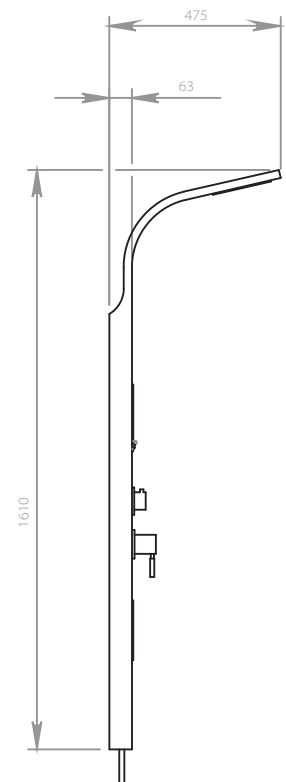
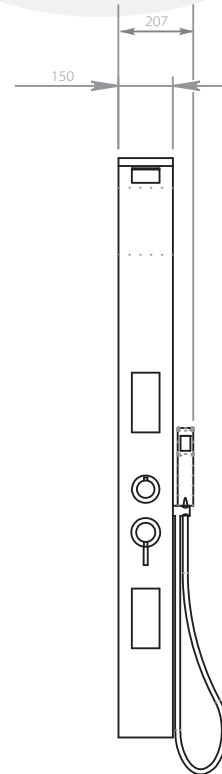



# G•SHOWER PANEL

## G•WELLNESS 00

GYSP10500  
25 x 55 x 145 cm



■ Nero  
Black  
Noir  
Schwarz  
Negro  
чернота

## G•WELLNESS 01

GYSP10501  
25 x 55 x 145 cm

□ Bianco  
White  
Blanc  
Weiss  
Blanco  
белый

Miscelatore termostatico  
Thermostatic mixer  
Mitigeur thermostatique  
Thermostatmischer  
Mezclador termostático  
Термостатический смеситель

ABS/Acciaio inox/Ottone  
ABS/Stainless steel/Brass  
ABS/Acier inox/Laiton  
ABS/Edelstahl/Messing  
ABS/Acero inox/Latón  
АБС/Нержавеющая  
сталь/Латунь

## G•WELLNESS 02

GYSP10502  
25 x 55 x 145 cm

■ Inox spazzolato  
Brushed stainless  
steel  
Acier inoxydable  
brossé  
Edelstahl gebürstet  
Acero inoxidable  
cepillado  
Матовая  
нержавеющая сталь

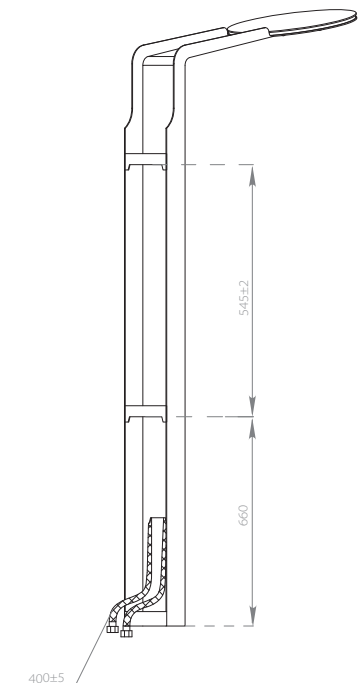
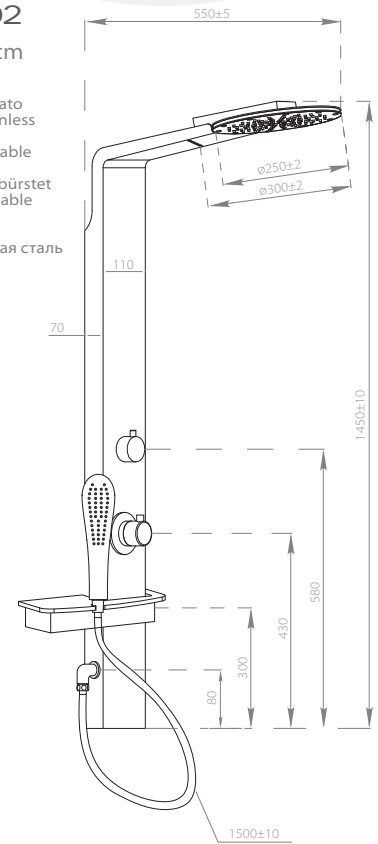



ABS/Acciaio inox/Ottone  
ABS/Stainless steel/Brass  
ABS/Acier inox/Laiton  
ABS/Edelstahl/Messing  
ABS/Acero inox/Latón  
АБС/Нержавеющая сталь/Латунь

# G•SHOWER PANEL

## G•SPA 00

GYSP10600  
20 x 45 x 167 cm

 Bianco  
White  
Blanc  
Weiss  
Blanco  
белый

## G•SPA 01

GYSP10601  
20 x 45 x 167 cm

 Nero  
Black  
Noir  
Schwarz  
Negro  
чернота

## G•SPA 02

GYSP10602  
20 x 45 x 167 cm

 Inox spazzolato  
Brushed stainless steel  
Acier inoxydable brossé  
Edelstahl gebürstet  
Acero inoxidable cepillado  
Матовая нержавеющая сталь



RAIN



WELLNESS



RAIN

**Miscelatore termostatico**  
Thermostatic mixer  
Mitigeur thermostatique  
Thermostatmischer  
Mezclador termostático  
Термостатический смеситель

**ABS/Acciaio inox/Ottone**  
ABS/Stainless steel/Brass  
ABS/Acier inox/Laiton  
ABS/Edelstahl/Messing  
ABS/Acero inox/Latón  
АБС/Нержавеющая  
сталь/Латунь

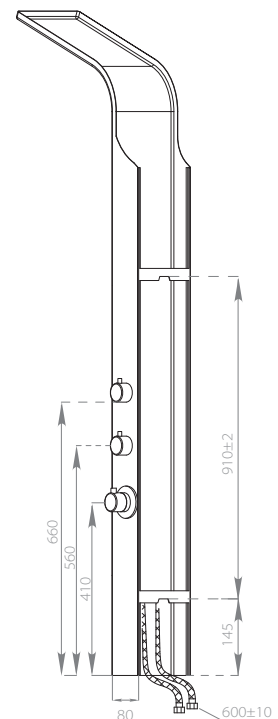
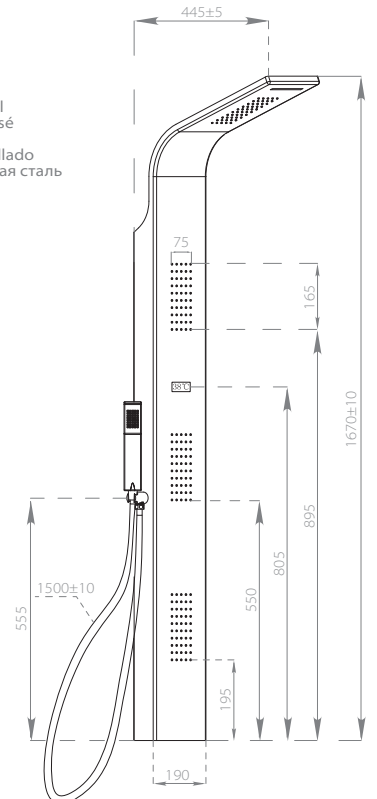



# G•SHOWER HEAD



Largo ventaglio di misure, funzioni, forme e materiali per i soffioni doccia Gedy, tutti dotati di filtro antisabbia, tecnologia water saving, tettarelle che permettono una rapida rimozione manuale del calcare.

Vaste gammes de dimensions, de fonctions, de formes et de matériaux pour les pommes de douche Gedy, toutes munies d'un filtre anti-sable, suivant la technologie water saving, des picots qui permettent une élimination manuelle rapide du calcaire.

Amplio abanico de medidas, funciones, formas y materiales para los rociadores ducha Gedy, todos dotados de filtro anti-arena, tecnología para el ahorro de energía, eyectores que permiten una rápida remoción manual de la cal.

Wide range of size, functions, shapes and materials for Gedy shower heads, all with sand filter, water saving technology and nipples for easy scale removal by hand.

Große Vielfalt von Größen, Funktionen, Formen und Materialien für die Duschstrahler Gedy, alle ausgestattet mit Sandfilter, Water-Saving-Technologie und Einsatz für die schnelle Entfernung von Kalkablagerungen.

Ассортимент леек Gedy представлен богатым выбором размеров, функций, форм и материалов. Все они оснащены фильтром для задержки песка, регулятором расхода воды и легко чистящимися от скопившейся накипи соплами.

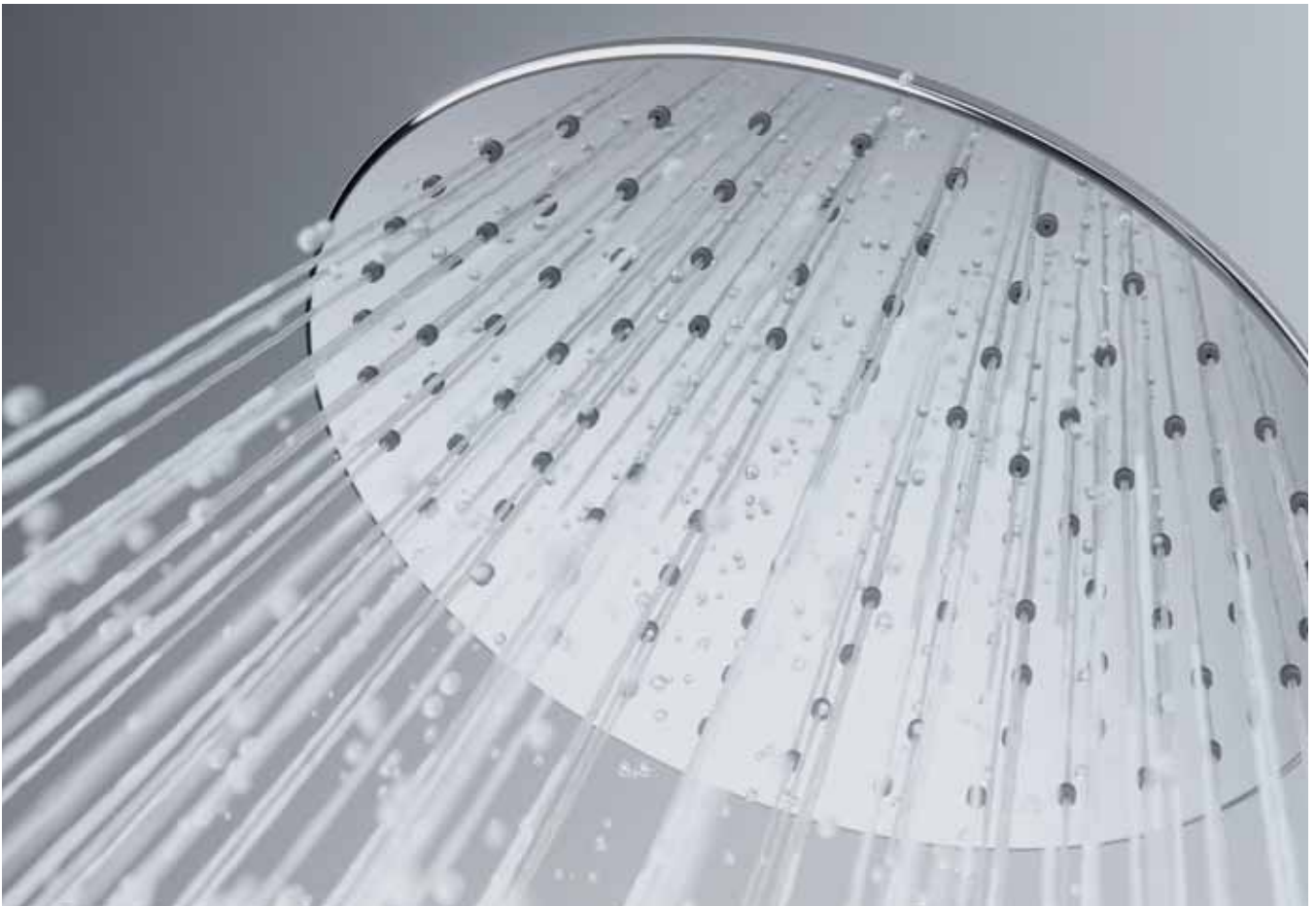

Filtro Antisabbia  
Sand filter  
Filtre anti-sable  
Sandschutzfilter  
Filtro antirena  
Универсальное крепление



Water Saving



Anticalcare  
Anti-limestone  
Anticalcaire  
Kesselsteinlösemittel  
Antical  
Защита от известкового налета



Pioggia  
Rain  
Pluie  
Regen  
Lluvia  
Дождик



Morbido  
Soft  
Moelleux  
Weich  
Suave  
Мягкая



Sottile  
Thin  
Fin  
Leicht  
Fino  
Тонкая



Doppio relax  
Double relax  
Double détente  
Doppleter Relax  
Doble Relax  
Супер релакс



Nebulizzato  
Spray  
Nébulisé  
Zerstäubt  
Nebulizado  
Распыление

Connessione  
**UNIVERSALE**  
Universal  
**CONNECTION**



col. 13  
Cromato/CHROMED  
Chromé  
Chrom  
Cromado  
Хром

**G•EASY 00**

GYSH10000

ø 7,2 x 9,5 cm

CROMATO/  
CHROMED**G•EASY 01**

GYSH10001

ø 7 x 10,5 cm

CROMATO/  
CHROMED**G•EASY 02**

GYSH10002

ø 7 x 8,5 cm

CROMATO/  
CHROMED**G•EASY 03**

GYSH10003

ø 10,2 x 6,5 cm

CROMATO/  
CHROMED**G•EASY 04**

GYSH10004

ø 10 x 8,5 cm

CROMATO/  
CHROMED

RAIN

TONIC

MASSAGE

RAIN+TONIC

RAIN+MASSAGE

**G•PLUS 00**

GYSH10100

20 x 20 x 5,5 cm

CROMATO/  
CHROMED**G•PLUS 01**

GYSH10101

ø 20 x 5 cm

CROMATO/  
CHROMED**G•PLUS 02**

GYSH10102

ø 20 x 6 cm

CROMATO/  
CHROMED

**G•PLUS 04**

GYSH10104

ø 23 x 5 cm

CROMATO/  
CHROMED

RAIN

**G•PLUS 05**

GYSH10105

ø 23 x 5 cm

CROMATO-BIANCO/  
WHITE-CHROMED

RAIN

**G•PLUS 06**

GYSH10105

ø 23 x 5 cm

NICHEL SPAZZOLATO/  
BRUSHED NICKEL

RAIN

**G•PLUS 03**

GYSH10103

20 x 20 x 6 cm

CROMATO/  
CHROMED

RAIN

**G•STAR 02**

GYSH10202

25 x 25 x 6 cm

CROMATO/  
CHROMED

RAIN

**G•LIGHT 00**

GYSH10700

ø 20,5 x 8 cm

CROMATO/  
CHROMED

RAIN

COLOR  
CHANGE**G•STAR 04**

GYSH10204

ø 25 x 5 cm

CROMATO/  
CHROMED

RAIN

**G•LIGHT 03**

GYSH10703

ø 25 x 8 cm

CROMATO/  
CHROMED

RAIN

COLOR  
CHANGE**G•MUSIC 00**

GYSH11100

ø 23 x 9 cm

CROMATO-BIANCO/  
WHITE-CHROMED

RAIN



BLUETOOTH

**G•TECH 00**

GYSH10300

ø 30 x 5 cm

CROMATO/  
CHROMEDAcciaio inox AISI 304  
Stainless steel 304 AISI  
Acier inox 304 AISI  
Rostfreier Stahl 304 AISI  
Acero inoxidable 304 AISI  
Нержавеющая сталь 304 AISI

RAIN

**G•TECH 02**

GYSH10302

ø 20 x 5 cm

**G•TECH 06**

GYSH10306

ø 40 x 5 cm

**G•TECH 04**

GYSH10304

ø 25 x 5 cm

**G•TECH 08**

GYSH10308

ø 50 x 5 cm

**G•TECH 01**

GYSH10301

30 x 30 x 5 cm

CROMATO/  
CHROMEDAcciaio inox AISI 304  
Stainless steel 304 AISI  
Acier inox 304 AISI  
Rostfreier Stahl 304 AISI  
Acero inoxidable 304 AISI  
Нержавеющая сталь 304 AISI

RAIN

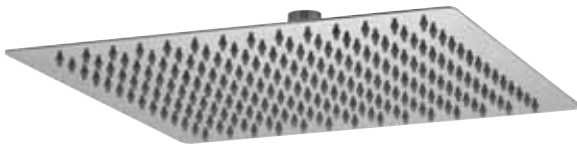
**G•TECH 03**

GYSH10303

20 x 20 x 5 cm

**G•TECH 07**

GYSH10307

40 x 40 x 5 cm

**G•TECH 05**

GYSH10305

25 x 25 x 5 cm

**G•TECH 09**

GYSH10309

50 x 50 x 5 cm

**G•LIBERTY 00**

GYSH10600

ø 20,5 x 10 cm

CROMATO/  
CHROMED

RAIN

**G•LIBERTY 01**

GYSH10601

ø 20,5 x 10 cm

BRONZO/BRONZE

**G•LIBERTY 02**

GYSH10602

ø 20,5 x 10 cm

RAME/COPPER

**G•DESIGN 01 design Simone Micheli**

GYSH10501

ø 50 x 1,5 cm

CROMATO BIANCO/  
WHITE CHROMED

RAIN



Novità - New

# G•FLEX

Tutti dotati di attacco universale 1/2" e di doppia aggraffatura, i flessibili Gedy sono presentati in un ampio ventaglio di materiali, finiture e misure disponibili.

Tous munis d'un raccord universel de 1/2 pouces et d'un double agrafage, les tuyaux flexibles Gedy sont présentés dans une vaste gamme de matériaux, de finitions et de dimensions.

Todos dotados de conexión universal 1/2" y de engrapado doble, los flexos Gedy están disponibles con un amplio abanico de materiales, acabados y medidas.

All complete with universal 1/2" fitting and dual crimping. Gedy hoses are available in a wide range of materials, finishes and sizes.

Alle ausgestattet mit Universalanschluss 1/2" und doppelter Rändelung: die Schläuche Gedy werden in einer Vielzahl von Materialien, Verarbeitungen und Größen angeboten.

Все шланги Gedy в двойной оплетке и имеют универсальное соединение 1 / 2", в наличии большой выбор материалов, отделок и размеров.



## G•BRASS 04

GYFX10004

ø 1,4 x 150-200 cm

CROMATO/  
CHROMED



## G•INOX 00

GYFX10100

ø 1,4 x 150 cm

CROMATO/  
CHROMED



## G•INOX 01

GYFX10101

ø 1,4 x 200 cm

CROMATO/  
CHROMED



## G•INOX 02

GYFX10102

ø 1,4 x 150 cm

CROMATO/  
CHROMED



## G•INOX 03

GYFX10103

ø 1,4 x 200 cm





**G•INOX 04**

GYFX10104

ø 1,4 x 150-200 cm

CROMATO/  
CHROMED**G•INOX 05**

GYFX10105

ø 1,4 x 150 cm

BRONZO/  
BRONZE**G•INOX 06**

GYFX10106

ø 1,4 x 200 cm

**G•INOX 07**

GYFX10107

ø 1,4 x 150 cm

RAME/COPPER

**G•INOX 08**

GYFX10108

ø 1,4 x 200 cm

**G•INOX 09**

GYFX10109

ø 1,4 x 150 cm

NICHEL SPAZZOLATO  
BRUSHED NICKEL**G•INOX 10**

GYFX10110

ø 1,4 x 200 cm

**G•INOX 11**

GYFX10111

ø 1,4 x 150 cm

INOX SPAZZOLATO  
BRUSHED STAINLESS**G•INOX 12**

GYFX10112

ø 1,4 x 200 cm

**G•WHITE 00**

GYFX10200

ø 1,4 x 150 cm

BIANCO / WHITE

**G•WHITE 01**

GYFX10201

ø 1,4 x 200 cm

**G•DOUBLE WHITE 00**

GYFX10300

ø 1,4 x 150 cm

CROMATO BIANCO/  
WHITE CHROMED**G•DOUBLE WHITE 01**

GYFX10301

ø 1,4 x 200 cm



**G•DOUBLE BLACK OO**

GYFX10400

ø 1,4 x 150 cm

CROMATO NERO/  
BLACK CHROMED**G•DOUBLE BLACK O1**

GYFX10401

ø 1,4 x 200 cm

**G•SUPER WHITE OO**

GYFX10500

ø 1,4 x 150 cm

CROMATO BIANCO/  
WHITE CHROMED**G•SUPER WHITE O1**

GYFX10501

ø 1,4 x 200 cm

**G•SUPER BLACK OO**

GYFX10600

ø 1,4 x 150 cm

CROMATO NERO/  
BLACK CHROMED**G•SUPER BLACK O1**

GYFX10601

ø 1,4 x 200 cm

**G•SILVER OO**

GYFX10700

ø 1,4 x 150 cm

ARGENTO/SILVER

**G•SILVER O1**

GYFX10701

ø 1,4 x 200 cm

# G•ACCESSORIES

Varie possibilità di sostituzione di accessori e particolari per la zona doccia, dai supporti per le doccette e i saliscendi, ai kit per la sostituzione areatori in varie misure, alle prese d'acqua, deviatori e braccetti con connessione universale.

Différentes possibilités de remplacement d'accessoires et de pièces pour la zone douche : supports de douchette, barres de douche, kits pour le remplacement des aérateurs dans différentes dimensions, prises d'eau, déviateurs et bras avec connexion universelle.

Varias posibilidades de sustitución de accesorios y detalles para la zona ducha, desde los soportes para los mangos de ducha y los soportes deslizantes, los kits para la sustitución aireadores de varias medidas, hasta las toma de agua, los desviadores y los brazos con conexión universal.

A host of replacement possibilities for accessories and details for the shower area, from brackets to sliding bars, kits for aerator replacement in different sizes, water inlets, deflectors and brackets with universal connection.

Erschiedene Möglichkeiten der Ersetzung von Zubehör- und Ersatzteile im Duschenbereich, von den Handduschenhalterungen zu den Wandschienen und von den Kits für die Ersetzung der Lüfter in verschiedenen Größen zu den Wasseranschlüssen, Umleitern und Armen mit Universalanschluss.

Богатый ассортимент аксессуаров и дополнений для душа, начиная от держателей для ручных душей и штанг до наборов для смены аэраторов различных размеров, соединений для подвода воды, девиаторов и держателей с универсальным креплением.



## G•BAR EASY 00

GYAC10000

11,6 x 8 x 60,5 cm - ø 1,9 cm

CROMATO/CHROMED



## G•BAR EASY 01

GYAC10001

11,2 x 5 x 65 cm

CROMATO/CHROMED



## G•BAR STAR 00

GYAC10100

ø 2,5 x 75-90 cm

CROMATO/CHROMED



**G•BAR STAR O1**

GYAC10101

ø 2,5 x 75-90 cm

CROMATO/  
CHROMED**G•BAR TENDENCE OO**

GYAC10200

12 x 7,5 x 66 cm

BIANCO/WHITE

**G•BAR STAR O2**

GYAC10102

ø 2,5 x 75-90 cm

NICHEL SPAZZOLATO  
BRUSHED NICKEL**G•BAR TENDENCE O1**

GYAC10201

12 x 7,5 x 66 cm

NERO/BLACK

**G•BAR TENDENCE O2**

GYAC10202

cm 13,5 x 20 x 80 - ø 2,5 cm

CROMATO BIANCO/  
WHITE CHROMED**G•BAR LIBERTY OO**

GYAC10300

ø 8 x 16 x 70 - ø 2,5 cm

CROMATO - CHROMED

**G•BAR TENDENCE O3**

GYAC10202

cm 13,5 x 20 x 80 - ø 2,5 cm

CROMATO NERO/  
BLACK CHROMED**G•BAR LIBERTY O1**

GYAC10301

ø 8 x 16 x 70 - ø 2,5 cm

BRONZO - BRONZE

**G•BAR LIBERTY O2**

GYAC10302

ø 8 x 16 x 70 - ø 2,5 cm

RAME - COPPER





**G•SLIDER OO**

GYAC99002

ø 4 x 12 cm

CROMATO - CHROMED

ABS

**SUPPORTO DOCCETTA UNIVERSALE PER ASTA SALISCENDI**  
UNIVERSAL HEAD SHOWER SUPPORT FOR SLIDING RAIL**G•CLIP EASY OO**

GYAC10400

ø 4 x 5 cm

CROMATO - CHROMED

ABS

**SUPPORTO DOCCETTA FISSO - CONNESSIONE UNIVERSALE**  
FIXED SHOWER BRACKET - UNIVERSAL CONNECTION**G•CLIP EASY O1**

GYAC10401

ø 6 x 6,8 cm

CROMATO - CHROMED

ABS

**SUPPORTO DOCCIA FISSO CON VENTOSA, 1 POSIZIONE**  
SUCTION CUP FIXED SHOWER BRACKET, 1 POSITION**G•CLIP EASY O2**

GYAC10402

ø 9,6 X 6 x 8,6 cm

CROMATO - CHROMED

ABS

**SUPPORTO DOCCIA FISSO CON VENTOSA, 2 POSIZIONI**  
SUCTION CUP FIXED SHOWER BRACKET, 2 POSITIONSSolo su superfici lisce (specchi, piastrelle)  
For flat surfaces (mirrors, tiles) onlyFissaggio con ventosa - Suction cup fixing  
Fixation avec ventouses - Befestigung mit Saugnapfen  
Fijación con ventosas - Крепление при помощи присосокSolo su superfici lisce (specchi, piastrelle)  
For flat surfaces (mirrors, tiles) onlyFissaggio con ventosa - Suction cup fixing  
Fixation avec ventouses - Befestigung mit Saugnapfen  
Fijación con ventosas - Крепление при помощи присосок

**G•CLIP PLUS 00**

GYAC10500

4 x 6,3 x 5,5 cm

CROMATO GRIGIO/  
GREY CHROMED  
ABS**SUPPORTO DOCCIA MOBILE**  
MOBILE SHOWER BRACKET**G•CLIP PLUS 01**

GYAC10501

4 x 6,3 x 5,5 cm

CROMATO BIANCO/  
WHITE CHROMED  
ABS**G•CLIP PLUS 03**

GYAC10503

4 x 6,3 x 5,5 cm

NICHEL SPAZZOLATO/BRUSHED NICKEL  
ABS**G•CLIP PLUS 02**

GYAC10502

4 x 6,3 x 5,5 cm

CROMATO NERO/  
BLACK CHROMED  
ABS**G•CLIP STAR 00**

GYAC10600

7,1 x 10,2 x 3,4 cm

CROMATO/CHROMED  
ABS**SUPPORTO DOCCIA MOBILE**  
MOBILE SHOWER BRACKET**G•CLIP TECH 00**

GYAC10700

9 x 7 x 4,2 cm

CROMATO/CHROMED  
ABS**SUPPORTO DOCCIA MOBILE**  
MOBILE SHOWER BRACKET**G•CLIP LIBERTY 00**

GYAC10800

ø 6 x 10 cm

CROMATO-OTTONE  
CHROMED-BRASS**G•CLIP LIBERTY 01**

GYAC10801

ø 6 x 10 cm

BRONZO-OTTONE  
BRONZE-BRASS**G•CLIP LIBERTY 02**

GYAC10802

ø 6 x 10 cm

RAME- OTTONE  
COPPER-BRASS**SUPPORTO DOCCIA MOBILE**  
MOBILE SHOWER BRACKET**G•CLIP LIBERTY 04**

GYAC10804

ø 6 x 10 cm

CROMATO - CHROMED  
ABS**SUPPORTO DOCCIA MOBILE**  
MOBILE SHOWER BRACKET



**G•OXY EASY 00**

GYAC10900

6 x 7 x 3,7 cm

CROMATO-OTTONE/  
CHROMED-BRASS**G•OXY EASY 01**

GYAC10901

6 x 7 x 3,7 cm

BRONZO-OTTONE/  
BRONZE-BRASS**G•OXY EASY 02**

GYAC10902

6 x 7 x 3,7 cm

RAME-OTTONE/  
COPPER-BRASS**G•OXY EASY 03**

GYAC10903

6 X 7 X 3,7 cm

NICHEL SPAZZOLATO-OTTONE/  
BRUSHED NICKEL-BRASS**G•OXY EASY 04**

GYAC10904

6,2 x 4,8 x 5,2 cm

CROMATO - CHROMED  
ABS**G•OXY EASY 05**

GYAC10905

6 x 7 x 3,7 cm

CROMATO-OTTONE/  
CHROMED -BRASS**G•OXY PLUS 00**

GYAC11000

5 x 5,5 x 6,5 cm

CROMATO-OTTONE/ CHROMED -BRASS

**G•OXY PLUS 01**

GYAC11001

5 x 5,5 x 6,5 cm

BRONZO-OTTONE/  
BRONZE-BRASS**G•OXY PLUS 02**

GYAC11002

5 x 5,5 x 6,5 cm

RAME-OTTONE/  
COPPER-BRASS**G•OXY PLUS 03**

GYAC11003

5 x 5,5 x 6,5 cm

NICHEL SPAZZOLATO-OTTONE/  
BRUSHED NICKEL-BRASS**G•OXY STAR 00**

GYAC11100

5 x 6 x 5 cm

CROMATO - CHROMED  
OTTONE-BRASS**G•OXY TECH 00**

GYAC11200

4,7 x 6 x 5 cm

CROMATO - CHROMED  
OTTONE-BRASS

**G•OXY CLIP EASY 00**

GYAC11300

5,5 x 8 x 5,8 cm

CROMATO - CHROMED  
OTTONE-BRASS**G•OXY CLIP PLUS 00**

GYAC11400

5 x 8,5 x 5,5 cm

CROMATO - CHROMED  
OTTONE-BRASS**G•OXY MIX 01**

GYAC10601

6 x 7,2 x 5,2 cm

CROMATO - CHROMED  
OTTONE-BRASS**G•OXY MIX 02**

GYAC11602

5 x 7,6 x 5,2 cm

CROMATO - CHROMED  
OTTONE-BRASS**G•OXY MIX CLIP 03**

GYAC11603

9,8 x 7 x 6,5 cm

CROMATO - CHROMED  
OTTONE-BRASS**G•OXY MIX CLIP 04**

GYAC11604

9,5 x 6,8 x 5,4 cm

CROMATO - CHROMED  
OTTONE-BRASS**G•SOAPY EASY 00**

GYAC11700

8 x 17 x 3,5 cm

CROMATO - CHROMED  
ABS

Ø 18-20-22-25 mm

**G•SOAPY EASY 01**

GYAC11701

10,3 x 13 x 3,2 cm

CROMATO - CHROMED  
ABS

Ø 18-20-22-25 mm

**G•SOAPY STAR 00**

GYAC11800

25 x 10 x 3 cm

CROMATO - CHROMED  
ABS

Ø 18-20-22-25 mm

**G•CROSS EASY 00**

GYAC11900

6,5 x 2,5 x 6,5 cm

CROMATO - CHROMED  
OTTONE - BRASS**G•CROSS EASY 04**

GYAC11904

7 x 2,3 x 7,5 cm

CROMATO - CHROMED  
ABS**G•CROSS EASY 05**

GYAC11905

6,5 x 2,5 x 6,5 cm

CROMATO-OTTONE/  
CHROMED - BRASS**G•CROSS TRENDY 00**

GYAC12000

6 x 3 x 6,2 cm

CROMATO-OTTONE/  
CHROMED - BRASS**G•TUBE EASY 00**

GYAC12100

Ø 2 x 15 cm

CROMATO - CHROMED  
ACCIAIO INOX  
STAINLESS STEEL**G•TUBE PLUS 15 00**

GYAC12300

Ø 6 x 15 cm

CROMATO - CHROMED  
ACCIAIO INOX - STAINLESS STEEL**G•TUBE TRENDY 15 00**

GYAC12500

Ø 2,5 x 2,5 x 15 cm

CROMATO-OTTONE/  
CHROMED - BRASS

**G•TUBE STAR 25 00**

GYAC12600

ø 6 x 25 cm

CROMATO - CHROMED

ACCIAIO INOX - STAINLESS STEEL

**G•TUBE STAR 30 00**

GYAC12700

ø 2 x 30 cm

CROMATO - CHROMED

ACCIAIO INOX - STAINLESS STEEL

**G•TUBE STAR 35 00**

GYAC12800

ø 5,5 x 37,2 x 11 cm

CROMATO - CHROMED

ACCIAIO INOX - STAINLESS STEEL

**G•TUBE STAR 35 01**

GYAC12801

ø 2 x 35 cm

BRONZO - BRONZE

ACCIAIO INOX - STAINLESS STEEL

**G•TUBE STAR 35 02**

GYAC12802

ø 2 x 35 cm

RAME - COPPER

ACCIAIO INOX - STAINLESS STEEL

**G•TUBE STAR 35 03**

GYAC12803

ø 2 x 35 cm

NICHEL SPAZZOLATO - BRUSHED NICKEL

ACCIAIO INOX - STAINLESS STEEL

**G•TUBE STAR 40 00**

GYAC12900

ø 2 x 40 cm

CROMATO - CHROMED

ACCIAIO INOX - STAINLESS STEEL

**G•TUBE TECH 25 00**

GYAC13000

2,5 x 2,5 x 25 cm

CROMATO - CHROMED

OTTONE-BRASS

**G•TUBE TECH 30 00**

GYAC13100

2,5 x 2,5 x 30 cm

CROMATO - CHROMED

OTTONE-BRASS

**G•TUBE TECH 35 00**

GYAC13200

2,5 x 2,5 x 35 cm

CROMATO - CHROMED

OTTONE-BRASS

**G•TUBE TECH 40 00**

GYAC13300

2,5 x 2,5 x 40 cm

CROMATO - CHROMED

OTTONE-BRASS

**G•TUBE TOP 30 00**

GYAC13400

3,5 x 1,5 x 30 cm

CROMATO - CHROMED

ACCIAIO INOX - STAINLESS STEEL

**G•TUBE TOP 35 00**

GYAC13500

3,5 x 1,5 x 35 cm

CROMATO - CHROMED

ACCIAIO INOX - STAINLESS STEEL

**G•TUBE TOP 40 00**

GYAC13600

3,5 x 1,5 x 40 cm

CROMATO - CHROMED

ACCIAIO INOX - STAINLESS STEEL

**G•TUBE TOP 45 00**

GYAC13700

3,5 x 1,5 x 45 cm

CROMATO - CHROMED

ACCIAIO INOX - STAINLESS STEEL

**G•TUBE LIBERTY 00**

GYAC13800

6 x 28 x 30 cm

CROMATO - CHROMED  
 ACCIAIO INOX -  
 STAINLESS STEEL

**G•TUBE LIBERTY 01**

GYAC13801

6 x 28 x 30 cm

BRONZO - BRONZE  
 ACCIAIO INOX - STAINLESS STEEL

**G•TUBE LIBERTY 02**

GYAC13802

6 x 28 x 30 cm

RAME - COPPER  
 ACCIAIO INOX - STAINLESS STEEL

**G•SPRAY TECH 00**

GYAC99300

5,8 x 12,4 x 2,2 cm

CROMATO - CHROMED  
 OTTONE-BRASS

**G•SPRAY TECH 01**

GYAC99301

6,2 x 12,4 x 2,2 cm

CROMATO - CHROMED  
 OTTONE-BRASS



# G•HYDRAULICS

## G•FLEXY 00

GHHY10000

ø 3 x 15 cm

BIANCO - WHITE

PVC - ACCIAIO INOX

PVC - STAINLESS STEEL



## G•FLEXY 01

GHHY10001

ø 3 x 9 cm

BIANCO - WHITE

PVC - ACCIAIO INOX

PVC - STAINLESS STEEL



## G•FLEXY 02

GHHY10002

ø 4 x 12 cm

CROMATO - CHROMED

PVC - ACCIAIO INOX

PVC - STAINLESS STEEL



## G•FLEXY 03

GHHY10003

ø 3 x 6 cm

CROMATO - CHROMED

PVC - ACCIAIO INOX

PVC - STAINLESS STEEL



## G•WATER SAVING 01

GHHY10401

ø 2,2 x 2 cm

CROMATO - CHROMED

ABS - OTTONE

ABS - BRASS



## G•WATER SAVING 02

GHHY10402

ø 3 x 4,2 cm

CROMATO - CHROMED

ABS - OTTONE

ABS - BRASS





**G•JOINT 00**

GHY10500

ø 2,5 x 4,5 cm

CROMATO - CHROMED  
 ACCIAIO INOX - OTTONE  
 STAINLESS STEEL - BRASS

**G•JOINT 01**

GHY10501

ø 2,5 x 4,5 cm

CROMATO - CHROMED  
 ACCIAIO INOX - OTTONE  
 STAINLESS STEEL - BRASS

**G•KEY 00**

GHY10600

5 x 2 x 8 cm

BLU - BLUE  
 ABS

**G•AERATOR 00**

GHY10700

ø 2,2 x 1,5 cm

CROMATO - CHROMED  
 ACCIAIO INOX - OTTONE  
 STAINLESS STEEL - BRASS

**G•AERATOR 01**

GHY10701

ø 2,2 x 1 cm

CROMATO - CHROMED  
 ACCIAIO INOX - OTTONE  
 STAINLESS STEEL - BRASS

**G•AERATOR 02**

GHY10702

ø 2,4 x 1 cm

CROMATO - CHROMED  
 ACCIAIO INOX - OTTONE  
 STAINLESS STEEL - BRASS

**G•AERATOR 02**

GYAC12703

ø 2,8 x 1 cm

CROMATO - CHROMED  
 ACCIAIO INOX - OTTONE  
 STAINLESS STEEL - BRASS

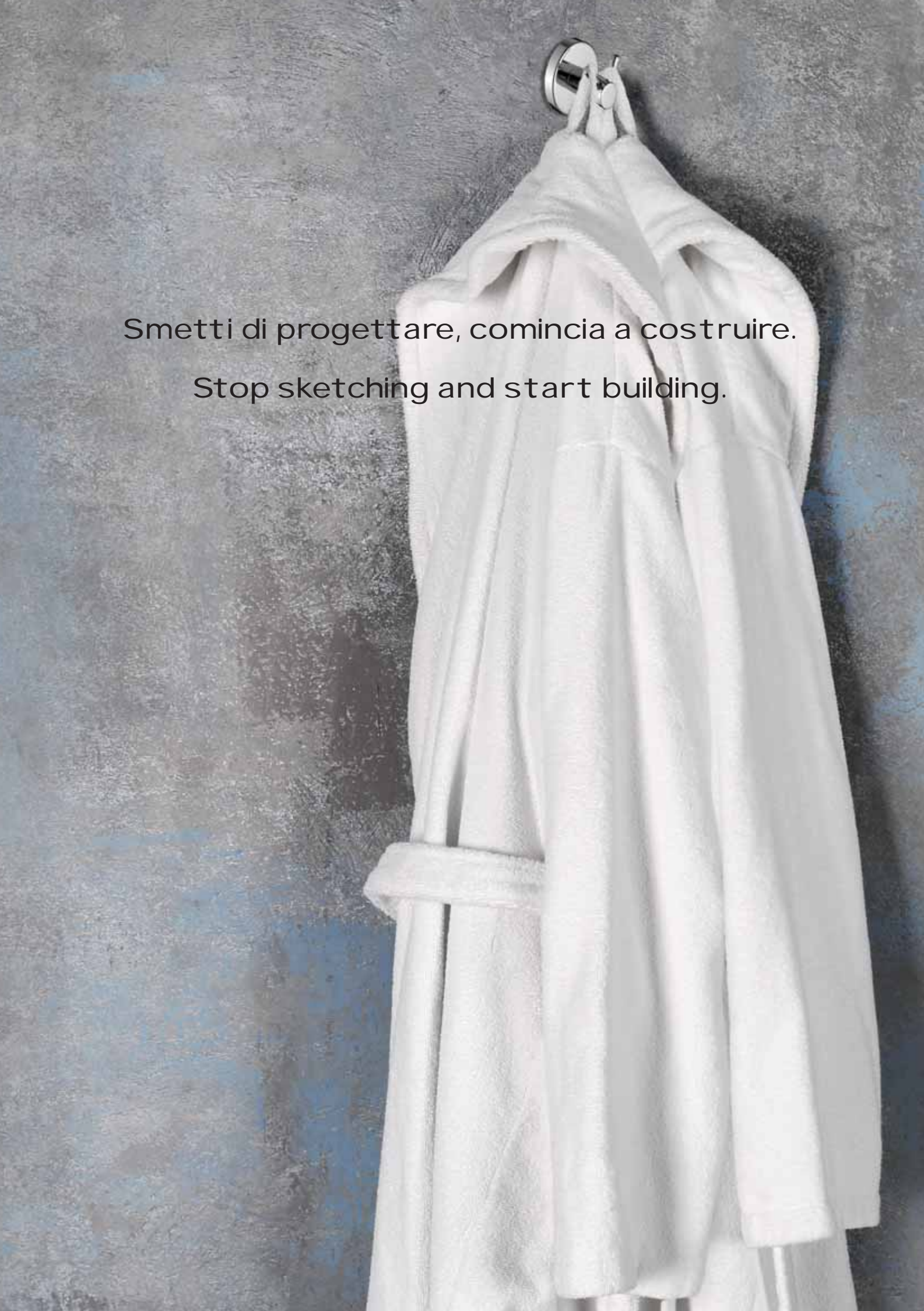

A white bathrobe is hanging from a silver metal hook on a textured, grey wall. The robe is folded at the top, and its long sleeves and body hang down. The background wall has a mottled, painterly texture with some blue and grey tones.

Smetti di progettare, comincia a costruire.

Stop sketching and start building.



project	pagina	566
dosatori	pagina	570
asciugamani elettrici	pagina	575
asciugacapelli	pagina	578
distributori di salviette ripiegate e rotoli di carta	pagina	580
mensole porta asciugamani	pagina	586
maniglioni	pagina	588
filo stendibiancheria riavvolgibile	pagina	590
materiale di consumo	pagina	591
prima classe	pagina	592
sicura	pagina	598
fortis	pagina	607



# CONTRACT





13

Lucido  
Polished

Novità - New

100%  
AISI 304

## G•PROJECT

Realizzato in acciaio inox AISI 304 con contenitori in vetro satinato

Made of AISI 304 stainless steel with satinized glass containers

Réalisée en acier inoxydable AISI 304 avec boîtiers en verre satiné

Hergestellt aus Edelstahl AISI 304 mit Behältern aus satiniertem Glas

Realizada en acero inox AISI 304 con contenedores en cristal satinado

Изготовлено из нержавеющей стали AISI 304

с ёмкостями из матового стекла

5010

7 x 11 x 10 cm



5011

11 x 13 x 6 cm



5081

7 x 11 x 15,2 cm



5021/30

30 x 8 x 5,3 cm

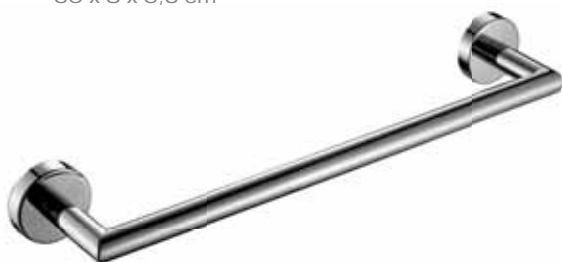

5021/45

45 x 8 x 5,3 cm



5021/60

60 x 8 x 5,3 cm



5070

16 x 6 x 18 cm







13

Lucido  
Polished

Novità - New

100%  
AISI 304

G•PROJECT

5027

5,3 x 6 x 5,3 cm



5035

50 x 25 x 16,5 cm



5026

5,3 x 6 x 5,3 cm



5025

12,3 x 8,8 x 6,7 cm



5033

16 x 12,5 x 37 cm



5024

17,7 x 7,3 x 5,3 cm



5024-02

6 x 7,3 x 17,7 cm



# Dosatori

Soap dispensers - Distributeurs de savon - Seifenspender  
 Dosificadores de jabon - Ёмкость для жидкого мыла

## A681 G•MALDIVE

7 x 8,6 x 23,8 cm - 200 ml



## A682 G•MALDIVE

5,5 x 7,1 x 21,6 cm - 350 ml



**Realizzati in ottone, Cromall®/Tritan™**

Made of brass, Cromall®/Tritan™

Réalisées en laiton, Cromall®/Tritan™

Hergestellt aus Messing, Cromall®/Tritan™

Realizados en latón, Cromall®/Tritan™

Изготовлено из латуни, Cromall®/Tritan™



13

Cromato  
Chromed

## 2086 G•KYRON

150 ml. - 5 x 10 x 17,1 cm



**Realizzati in ottone**

Made of brass

Réalisés en laiton

Hergestellt aus Messing

Realizados en latón

Изготовлено из латуни

13

Cromato  
Chromed

## 2087 G•KUBIX

1200 ml. - 10 x 11 x 32 cm



**Realizzato in acciaio inox  
e resine termoplastiche**

Made of stainless steel and thermoplastic resins

Réalisé en acier inoxydable et thermoplastique

Hergestellt aus Edelstahl und Kunststoff

Realizado en acero inox y resinas termoplásticas

Изготовлено из нержавеющей стали и термопластичных смол



13

Lucido  
Polished

**2081 G•EPOS**

800 ml - 11,5 x 10,5 x 18 cm

**2082 G•EPOS**

1200 ml. - cm. 12,7 x 10,5 x 20,3 cm



**Realizzati in acciaio inox**  
 Made of stainless steel  
 Réalisés en acier inoxydable  
 Hergestellt aus Edelstahl  
 Realizados en acero inox  
 Изготовлено  
 из нержавеющей стали

21

Lucido/  
 satinato  
 Polished/  
 satinized

**2075 G•WHALE**

400 ml - 12 x 11 x 15,2 cm

**2076 G•WHALE**

1000 ml - 13 x 11 x 22 cm



**Realizzato in acciaio inox e ABS**  
 Made of stainless steel and ABS  
 Réalisé en acier inoxydable et ABS  
 Hergestellt aus Edelstahl und ABS  
 Realizado en acero inox y ABS  
 Изготовлено из нержавеющей стали и ABS

38

Spazzolato  
 Brushed

**2090 G•FEEL**

500 ml. - 11 x 10,5 x 22,2 cm

**Realizzato in resine termoplastiche**

Made of thermoplastic resins  
 Réalisé en thermoplastique  
 Hergestellt aus Kunststoff  
 Realizado en resinas termoplásticas  
 Изготовлено из термопластичных смол

CON FOTOCCELLULA - WITH PHOTOCCELL  
 AVEC DETECTEUR - DE MOUVEMENT  
 SEIFENSPENDER MIT LICHTSCHRANKE  
 CON FOTOCÉLULA - С ФОТОЭЛЕМЕНТОМ

**4xAA non include - not included**

02

Bianco  
 White



**2088 G•TOUCH**

500 ml. - 10,1 x 9,3 x 20,9 cm

**2089 G•TOUCH**

1000 ml. - 11 x 10,5 x 27,5 cm

**Realizzati in resine termoplastiche**

Made of thermoplastic resins

Réalisés en thermoplastique

Hergestellt aus Kunststoff

Realizados en resinas termoplásticas

Изготовлено из термопластичных смол

**02**Bianco  
White**2096 G•SHARK**

700 ml - 8,5 x 12 x 21 cm

**Distributore di sapone in schiuma**

Foam soap dispenser

Distributeur de savon en mousse

Schaumseifenspender

Dosificador de jabon en espuma

Schuimzeepdispenser

Диспенсер пенистого мыла

**Realizzato in resine termoplastiche**

Made of thermoplastic resins

Réalisé en thermoplastique

Hergestellt aus Kunststoff

Realizado en resinas termoplásticas

Изготовлено из термопластичных смол

**02**Bianco  
White**13**Cromato  
Chromed**Biadesivo incluso**Adhesive included - Ruban adhésif fourni - Doppelklebeband  
inklusive - Cinta adhesiva incluida - Двусторонняя клейкая  
лента включена**2681 G•RALLY**

1000 ml. - 10 x 11 x 20 cm

**Realizzato in resine termoplastiche**

Made of thermoplastic resins

Réalisé en thermoplastique

Hergestellt aus Kunststoff

Realizado en resinas termoplásticas

Изготовлено из термопластичных смол

**02**Bianco  
White**13**Cromato  
Chromed

**2280 G•PUSH** Design: Makio Hasuike

600 ml. - 11 x 9 x 20,8 cm



100%  
made in Italy

02

Bianco  
White

**Realizzato in resine termoplastiche**  
Made of thermoplastic resins  
Réalisé en thermoplastique  
Hergestellt aus Kunststoff  
Realizado en resinas termoplásticas  
Изготовлено из термопластических смол

**2097 G•COD**

500 ml - 10,4 x 9,5 x 16,3 cm



13

Cromato  
Chromed

**Realizzato in resine termoplastiche**  
Made of thermoplastic resins  
Réalisé en thermoplastique  
Hergestellt aus Kunststoff  
Realizado en resinas termoplásticas  
Изготовлено из термопластических смол

**2093 G•TORPEDO**

300 ml - 9 x 8,6 x 16 cm



02

Bianco  
White

13

Cromato  
Chromed**2094 G•TORPEDO**

600 ml - 11 x 9,5 x 19,5 cm



02

Bianco  
White**Resine termoplastiche**

Thermoplastic resins  
Thermoplastique  
Metall und Kunststoff  
Metal y resinas termoplásticas  
Металл и термопластичные смолы

**2091 G•MARLIN**

300 ml - 5 x 11 x 14 cm

**Realizzati in resine termoplastiche**

Made of thermoplastic resins  
Réalisés en thermoplastique  
Hergestellt aus Kunststoff  
Realizados en resinas termoplásticas  
Изготовлено из термопластичных смол

02

Bianco  
White

13

Cromato  
Chromed



## 2092 G•SNAPPER

450 ml - 10 x 8 x 16,4 cm



### Realizzato in resine termoplastiche

Made of thermoplastic resins

Réalisé en thermoplastique

Hergestellt aus Kunststoff

Realizado en resinas termoplásticas

Изготовлено из термопластичных смол

02

Bianco  
White

## 2084

340 ml - 5,7 x 11,5 x 25,5 cm



### Dosatore da incasso per top lavabo

Built-in dispenser for washbasin top

Distributeur à encastrer pour dessus lavabo

Einbau-Seifenspender für Waschbecken-Top

Dosificador empotrado para top lavabo

Встраиваемый дозатор для умывальника

### Ottone e resine termoplastiche

Brass and thermoplastic resins - Laiton et thermoplastique

Messing und Kunststoff - Latón y resinas termoplásticas

Латунь и термопластичные смолы

13

Cromato  
Chromed

# Asciugamani elettrici

Air hand dryer - Sèche-mains - Händetrockner - Secador de manos - Электрическая сушилка

100%  
made in Italy



Novità - New

G•DIABLO



2453

29,6 x 17,7 x 56,6 cm

**Asciugamani elettrico a fotocellula Eco-Jet ad inserimento verticale delle mani**

Photocell electronic hand-dryer with photocell for vertical insertion of hands  
Sèche-mains électrique à cellule photoélectrique Eco-Jet à introduction des mains verticale - Elektrischer Händetrockner mit Öko-Jet-Fotozelle und vertikaler Handeinführung - Secador de manos eléctrico con fotocélula Eco-Jet con introducción vertical de las manos

02

Bianco  
White

08

Grigio  
Grey



ABS - АБС пластик

CE 1450 W - 220-240 V  
50-60 Hz - IP31



Novità - New

G•BORA

2454

22,1 x 15,7 x 28,5 cm



Asciugamani elettrico a fotocellula Eco-Jet  
Eco Jet electric hand dryer with photocell

Sèche-mains électrique à cellule  
photoélectrique Eco-Jet

Elektrischer Händetrockner mit Öko-Jet-Fotocelle  
Secador de manos eléctrico con fotocélula Eco-Jet

Elektrische handdrogers met Eco-Jet fotocel

Электрическая сушилка для рук с фотоэлементом

02

Bianco  
White

13

Cromato  
Chromed

85

Antracite  
satinato  
Anthracite  
satinized

Acciaio inox AISI 304

Stainless steel AISI 304

Acier inoxydable AISI 304

Edelstahl AISI 304

Нержавеющая сталь AISI 304

CE 1100 W - 220-240 V  
50-60 Hz - IP20

100%  
made in Italy



Novità - New

G•ALIZÉ

2455

15,6 x 9,9 x 23,8 cm



Asciugamani elettrico a fotocellula  
Eco-Jet

Eco Jet electric hand dryer  
with photocell

Sèche-mains électrique à cellule  
photoélectrique Eco-Jet

Elektrischer Händetrockner mit  
Öko-Jet-Fotocelle

Secador de manos eléctrico  
con fotocélula Eco-Jet

Elektrische handdrogers met  
Eco-Jet fotocel

Električno sušilo za ruke na  
fotocelije Eco-Jet

02

Bianco  
White

13

Cromato  
lucido  
Chromed

21

Satinato  
Satinized

14

Nero  
Black

ABS - АБС пластик

CE 900 W - 220-240 V  
50-60 Hz - IP23

100%  
made in Italy

# G•BRISA

Novità - New

## 2456

26,2 x 16,5 x 30,5 cm



### Asciugamani con motore ad induzione con fotocellula

Towel with induction motor and photocell  
Sèche-mains à moteur à induction à cellule photoélectrique

Händetrockner mit Induktionsmotor und Fozozelle

Secador de manos con motor de inducción con fotocélula

Сушилка для рук с индукционным двигателем и фотоэлементом

02

Bianco  
White

13

Cromato  
Lucido  
Chromed

ABS - АБС пластик

100%  
made in Italy



## 2451

28,4 x 24,8 x 20,2 cm



02

Bianco  
White

### Asciugamani antivandalo ad aria calda con pulsante

Vandal-proof hot air hand dryer with pushbutton action

Sèche-mains anti-vandalisme à air chaud avec bouton

Bruchsicherer Heissluft-Händetrockner mit Taste

Secador de aire caliente para las manos resistente al vandalismo con pulsador

Сушилка для рук с защитой от вандалов, с горячим воздухом и кнопкой

### Acciaio porcellanato

Vitreous enamel steel - Acier émaillé - Emaille - Acero porcelanizado

Сталь, обработанная под фарфор

CE

W 2400 - IPX1

# Asciugacapelli

Hair dryer - Sèche cheveux - Haartrockner - Secador para el cabello - Фен

## G•GRECALE SHAVER

5054

11 x 31,5 x 36,5 cm



### Asciugacapelli con presa rasoio

Hair dryer with electrical socket for shavers  
Sèche cheveux avec prise pour les rasoirs  
Haartrockner mit Steckdose für Rasierapparaten  
Secador de pelo com toma de corrente para maquinillas de afeitar  
Фен с розеткой для электробритов

### Resine termoplastiche/acciaio inox

Thermoplastic resins/stainless steel  
Thermoplastique/acier inoxydable  
Kunststoff/Edelstahl  
Resinas termoplásticas/acero inox  
Термопластическая смола/  
нержавеющая сталь

CE □ W 1300 - IP23

43  
Nero/  
Cromato  
Black/  
Chromed

## G•ZEFIRO

5053

9 x 15 x 33 cm



### Asciugacapelli

Hair dryer - Sèche cheveux  
Haartrockner  
Secador de pelo - Фен

### Resine termoplastiche

Thermoplastic resins  
Thermoplastique  
Kunststoff  
Resinas termoplásticas  
Термопластические смолы

CE □ W 1200 - IP23

02  
Bianco  
White

# G•ALBATROS

5052

9,5 x 23 x 15,7 cm

Design: Antonio Rossari



**Asciugacapelli con supporto a parete**

Hair dryer with wall support

Sèche cheveux avec support mural

Haartrockner mit Wandhalter

Secador para el cabello con soporte - Фен

02

Bianco  
White

**Resine termoplastiche**

Thermoplastic resins - Thermoplastique

Metall und Kunststoff

Metal y resinas termoplásticas

Металл и термопластичные смолы



W 1200 - IP20

# G•LEVANTE

5057

27 x 14,5 x 19 cm

Novità - New



**Asciugacapelli 1650 W**

Hair dryer 1650 W

Sèche cheveux 1650 W

Haartrockner 1650 W

Secador de pelo 1650 W

Фен 1650 W

02

Bianco  
White

ABS - АБС пластик

# G•MAESTRALE

5058

25 x 14 x 22 cm

Novità - New



**Asciugacapelli 1800 W**

Hair dryer 1800 W

Sèche cheveux 1800 W

Haartrockner 1800 W

Secador de pelo 1800 W

Фен 1800 W

02

Bianco  
White

ABS - АБС пластик



# Distributori di salviette ripiegate e rotoli di carta

Tissue and rollpaper dispenser - Distributeur serviettes et papier à rouleau  
Tuchspender und Rollenpapierspender - Dispensador de toallas y do rolo de papel  
Ёмкость для бумажных салфеток и ёмкость для туалетной бумаги

## 2436

28 x 10 x 36,5 cm



### Distributore salviette carta - max 400 fogli

Tissue dispenser - max 400 tissues  
Distributeur serviettes - max 400 serviettes  
Tuchspender - max 400 Tücher  
Dispensador de toallas - max 400 toallas  
Ёмкость для бумажных салфеток.  
максимальные 400 тканей

### Acciaio inox AISI 304

Stainless steel AISI 304  
Acier inoxydabile AISI 304  
Edelstahl AISI 304  
Нержавеющая сталь AISI 304

13

Lucido  
Polished

## 2444

26,2 x 9 x 33 cm



### max 400 fogli

max 400 tissues  
max 400 serviettes  
max 400 Tücher  
max 400 toallas  
максимальные 400 тканей

### Acciaio inox AISI 304

Stainless steel AISI 304 - Acier inoxidable AISI 304  
Edelstahl AISI 304 - Acero inox AISI 304  
Нержавеющая сталь AISI 304

38

Acciaio  
Spazzolato  
Brushed  
steel

2427

28 x 14 x 40 cm



02

Bianco  
White100%  
made in Italy**Distributore di salviette di carta piegate**

Dispenser for papersheets - Distributeur serviettes en feuille  
Tuchspender für Einzelblätter - Dispensador de toallitas  
Ёмкость для бумажных салфеток

**Resine termoplastiche**

Thermoplastic resins - Thermoplastique - Kunststoff  
Resinas termoplásticas - Термопластичные смолы

**Ricambio salviette ripiegate art. 2151**

Folded towels refill art. 2151 - Pièce de recharge petites serviettes pliées art. 2151 - Nachfüllungsteil gefaltete kleine Tücher art. 2151  
Pieza de recarga toallitas dobladas art. 2151 - Сложенные салфетки 2151

2426

28 x 18 x 25 cm - max ø 15



02

Bianco  
White100%  
made in Italy**Distributore salviette di carta piegate o a rotolo**

Dispenser for papersheets or paper-rolls - Distributeur papier en feuilles ou en rouleau - Papierspender für Einzelblätter oder Rollen- Dispensador de toallitas o de papel en rollo - Ёмкость для салфеток или рулона

**Resine termoplastiche**

Thermoplastic resins - Thermoplastique - Kunststoff  
Resinas termoplásticas - Термопластичные смолы

**Ricambio salviette ripiegate art. 2154**

Folded towels refill art. 2154 - Pièce de recharge petites serviettes pliées art. 2154 - Nachfüllungsteil gefaltete kleine Tücher art. 2154  
Pieza de recarga toallitas dobladas art. 2154 - Сложенные салфетки 2154

2437

17,8 x 18 x 31,8 cm - max ø 16



02

Bianco  
White100%  
made in Italy**Distributore di carta asciugamani a spirale**

Spiral paper hand towel dispenser  
Distributeur de papier essuie-mains en spirale  
Handtuchrollen-Spender  
Dispensador de toallitas para secar las manos en espiral  
Спиральный диспенсер бумаги для рук

**Resine termoplastiche**

Thermoplastic resins - Thermoplastique  
Kunststoff - Resinas termoplásticas - Термопластичные смолы

2442

27,2 x 11 x 28,8 cm



02

Bianco  
White

11

Azzurro  
Light blue**max 300 fogli**

max 300 tissues - max 300 serviettes - max 300 Tücher  
max 300 toallas - максимальные 300 тканей

**Resine termoplastiche**

Thermoplastic resins - Thermoplastique  
Kunststoff - Resinas termoplásticas - Термопластичные смолы

**2440**

26,5 x 11 x 29 cm

**11**Azzurro  
Light blue**85**Antracite  
Anthracite

max 200 fogli - max 200 tissues - max 200 serviettes - max 200  
Tücher - max 200 toallas - максимальные 200 тканей

**Resine termoplastiche**

Thermoplastic resins - Thermoplastique- Kunststoff - Resinas  
termoplásticas - Термопластичные смолы

**2424**

31 x 12,5 x 32 cm - Max ø 31 cm

**13**Lucido  
Polished**Distributore di carta a rotoli**

Rollpaper dispenser

Distributeur papier à rouleau

Rollenpapierspender - Dispensador rollos de papel

Ёмкость для туалетной бумаги

**Acciaio inox AISI 304**

AISI 304 stainless steel - acier inoxydable AISI 304

Edelstahl AISI 304 - acero inox AISI 304

нержавеющая сталь AISI 304

**2445**

27,8 x 13 x 28,5 cm - Max ø 27,5

**38**Acciaio  
spazzolato  
Brushed steel**Acciaio inox AISI 304**

Stainless steel AISI 304

Acier inoxydable AISI 304

Edelstahl AISI 304

Acero inox AISI 304

Нержавеющая сталь AISI 304

**2446**

ø 27,8 x 13 x 28,5 - Max ø 27,5 cm

**Novità - New****13**Lucido  
Polished**Distributore di carta a rotoli**

Rollpaper dispenser

Distributeur papier à rouleau

Rollenpapierspender - Dispensador rollos de papel

Ёмкость для туалетной бумаги

**Acciaio inox AISI 304**

AISI 304 stainless steel - acier inoxydable AISI 304

Edelstahl AISI 304 - acero inox AISI 304

нержавеющая сталь AISI 304

## 2429 G • JUMBO MAXI

37,5 x 13,5 x 36 cm - Max ø 34



02

Bianco  
White

100%  
made in Italy



### Distributore di carta a rotoli

Rollpaper dispenser  
Distributeur papier à rouleau  
Rollenpapierspender  
Dispensador rollos de papel  
Ёмкость для туалетной бумаги

### Resine termoplastiche

Thermoplastic resins - Thermoplastique  
Kunststoff - Resinas termoplásticas  
Термопластичные смолы

## 2428 G • JUMBO MINI

27 x 12 x 25,5 cm - Max ø 24,5



02

Bianco  
White

100%  
made in Italy



### Distributore di carta a rotoli

Rollpaper dispenser  
Distributeur papier à rouleau  
Rollenpapierspender  
Dispensador rollos de papel  
Ёмкость для туалетной бумаги

### Resine termoplastiche

Thermoplastic resins - Thermoplastique  
Kunststoff - Resinas termoplásticas  
Термопластичные смолы

## 2443

26 x 12,6 x 27 cm - Max ø 22



02

Bianco  
White

11

Azzurro  
Light blue

### Distributore di carta a rotoli

Rollpaper dispenser - Distributeur papier à rouleau  
Rollenpapierspender - Dispensador rollos de papel  
Ёмкость для туалетной бумаги

### Resine termoplastiche

Thermoplastic resins - Thermoplastique - Kunststoff - Resinas termoplásticas - Термопластичные смолы

## 2441

21,3 x 12,2 x 24,5 cm - Max ø 19



85

Antracite  
Anthracite

### Distributore di carta a rotoli

Rollpaper dispenser - Distributeur papier à rouleau  
Rollenpapierspender - Dispensador rollos de papel  
Ёмкость для туалетной бумаги

### Resine termoplastiche

Thermoplastic resins - Thermoplastique - Kunststoff - Resinas termoplásticas - Термопластичные смолы

2339

26 x 10 x 10,6 cm

Novità - New

13  
Lucido  
Polished

**Portarotolo doppio coperto con piano d'appoggio**  
 Double toilet paper holder with support stand  
 Porte rouleau papier WC couvert  
 Doppelte Rollenhalterung, abgedeckt durch Auflagefläche  
 Portarrollos doble cubierto con superficie de apoyo  
 Стойка с двойным закрытым держателем рулона

**Acciaio inox AISI 304**  
 Stainless steel AISI 304 - Acier inoxydable AISI 304  
 Edelstahl AISI 304 - Acero inox AISI 304  
 Нержавеющая сталь AISI 304

2525

12 x 14,2 x 7,2 cm

13  
Cromato  
Chromed

**Portarotolo coperto**  
 Paper holder with cover  
 Porte rouleau avec couvercle  
 Papierrollenhalter mit Deckel  
 Portarrollo con tapa  
 Бумагодержатель с крышкой

**Acciaio inox/ Cromall®**  
 Stainless steel/ Cromall®  
 Acier inoxydable/Cromall®  
 Edelstahl/Cromall®  
 Acero inox/Cromall®  
 Нержавеющая сталь/Cromall®

2439

14 x 13,5 x 15 cm

02  
Bianco  
White

100%  
made in Italy

**Distributore di carta igienica a rotoli o intercalata**  
 Toilet paper dispenser for rolls or squares  
 Distributeur papier toilette en rouleau ou feuille a feuille  
 Toilettenpapierspender für rolle oder Einzelblatt  
 Dispensador papel higiénico en rollos o en hojas  
 Дисенсер туалетной бумаги рулонный и листовой

**Resine termoplastiche**  
 Thermoplastic resins - Thermoplastique  
 Kunststoff - Resinas termoplásticas  
 Термопластичные смолы

2308

25,4 x 7,6 x 13,1 cm

13  
Lucido  
Polished

**Porta fazzoletti**  
 Tissue box  
 Boîte à mouchoirs  
 Tücherbehälter  
 Porta pañuelos  
 Ёмкость для салфеток

**Acciaio inox AISI 304**  
 Stainless steel AISI 304 - Acier inoxydable AISI 304  
 Edelstahl AISI 304 - Acero inox AISI 304  
 Нержавеющая сталь AISI 304

2002

13,4 x 13,4 x 13 cm

Novità - New



13

Lucido  
Chromed**Porta fazzoletti**

Tissue box  
Boîte à mouchoirs  
Tücherbehälter  
Porta pañuelos  
Ёмкость для салфеток

**Acciaio inox AISI 304**

Stainless steel AISI 304 - Acier inoxydable AISI 304  
Edelstahl AISI 304 - Acero inox AISI 304  
Нержавеющая сталь AISI 304

2008

25,8 x 13,2 x 6,3 cm

Design: Makio Hasuike

02

Bianco  
White

13

Lucido  
Chromed**Porta fazzoletti**

Tissue box  
Boîte à mouchoirs  
Tücherbehälter  
Porta pañuelos  
Ёмкость для салфеток

**Resine termoplastiche**

Thermoplastic resins - Thermoplastique  
Kunststoff - Resinas termoplásticas  
Термопластичные смолы

100%  
made in Italy



2330

13,4 x 26 x 9 cm

Novità - New



13

Lucido  
Polished**Porta sacchetti igienici**

Holder for sanitary towel bags - Porte-sachets hygiéniques  
Behälter für Hygienebeutel - Porta-bolsitas higiénicas  
Урна для гигиенических прокладок

**Acciaio inox AISI 304**

Stainless steel AISI 304 - Acier inoxydable AISI 304  
Edelstahl AISI 304 - Acero inox AISI 304  
Нержавеющая сталь AISI 304

2430

9,8 x 3,8 x 13,5 cm

02

Bianco  
White

13

Lucido  
Polished**Porta sacchetti igienici**

Holder for sanitary towel bags - Porte-sachets hygiéniques  
Behälter für Hygienebeutel - Porta-bolsitas higiénicas  
Урна для гигиенических прокладок

**Fissaggio con biadesivo o viti - resine termoplastiche**

Biadhesive or screw fixing - thermoplastic resins - Applicable avec biadhésif ou vis - thermoplastique - Mit doppelseitiger Klebstreifen oder Schrauben aufhängbar - Kunststoff - Aplicabile con biadesivo o tornillos - resinas termoplásticas - крепление винтами или двусторонней липкой лентой термопластичная смола

100%  
made in Italy





# Mensole porta asciugamani

Shelves for towels - Etagères porte serviette - Handtuchablage  
Estantes para toallas - Держатель полотенец

13

Cromato  
Chromed

## A235 G•CANARIE

62 x 25 x 14,5 cm

### Ottone/Cromall®

Brass/Cromall® - Laiton/Cromall®  
Messing/Cromall® - Latón/Cromall®  
Латунь/ Cromall®



## 3235 G•OUTLINE

Design: Simone Micheli

50 x 26 x 14 cm

### Acciaio inox/Ottone/Cromall®

Stainless steel/Brass/Cromall® - Acier inoxydable/Laiton/Cromall®  
Edelstahl/Messing/Cromall® - Acero inox/Latón/Cromall®  
Нержавеющая сталь/Латунь/ Cromall®

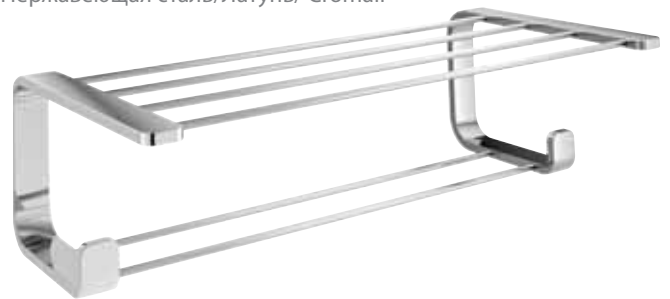

## 5335 G•FEBO

52,4 x 25,2 x 12 cm

### Acciaio inox/Cromall®

Stainless steel/Cromall® - Acier inoxydable/Cromall®  
Edelstahl/Cromall® - Acero inox/Cromall®  
Нержавеющая сталь/ Cromall®

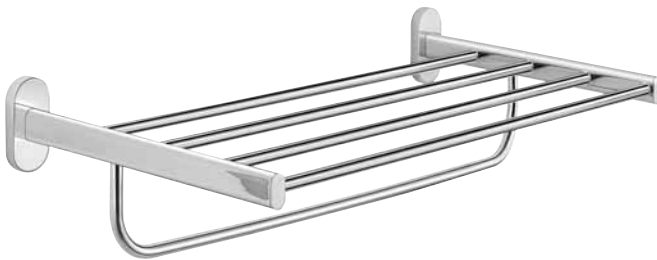

## 5344 G•FEBO

52,4 x 25,2 x 7 cm

### Acciaio inox/Cromall®

Stainless steel/Cromall® - Acier inoxydable/Cromall®  
Edelstahl/Cromall® - Acero inox/Cromall®  
Нержавеющая сталь/ Cromall®



## 5035 G•PROJECT

50 x 25 x 16,5 cm

### Acciaio inox AISI 304

Stainless steel AISI 304 - Acier inoxydable AISI 304  
Edelstahl AISI 304 - Acero inox AISI 304  
Нержавеющая сталь AISI 304

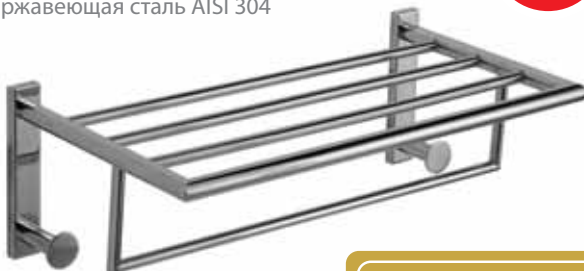
100%  
AISI 304

Novità - New

## 2435 G•ASCOT

Design: Carlo Vietri

59,8 x 30,1 x 15,9 cm

### Acciaio inox/Cromall®

Stainless steel/Cromall® - Acier inoxydable/Cromall®  
Edelstahl/Cromall® - Acero inox/Cromall®  
Нержавеющая сталь/ Cromall®

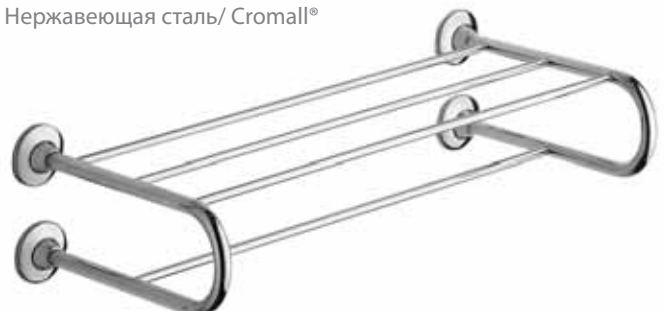

**2735 G•ASCOT**

Design: Carlo Vietri

60,4 x 30,4 x 12 cm

**Acciaio inox/Cromall®**Stainless steel/Cromall® - Acier inoxydable/Cromall®  
Edelstahl/Cromall® - Acero inox/Cromall®  
Нержавеющая сталь/ Cromall®**2744 G•ASCOT**

Design: Carlo Vietri

60,4 x 30,4 x 5,9 cm

**Acciaio inox/Cromall®**Stainless steel/Cromall® - Acier inoxydable/Cromall®  
Edelstahl/Cromall® - Acero inox/Cromall®  
Нержавеющая сталь/ Cromall®**ED35 G•EDERA**

62,4 x 25,3 x 11,2 cm

**Acciaio inox/Cromall®**Stainless steel/Cromall® - Acier inoxydable/Cromall®  
Edelstahl/Cromall® - Acero inox/Cromall®  
Нержавеющая сталь/ Cromall®**ED44 G•EDERA**

62,4 x 25,3 x 5 cm

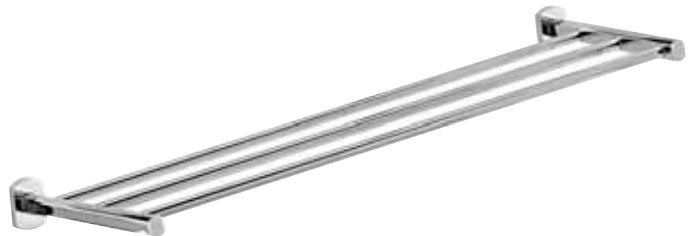
**Acciaio inox/Cromall®**Stainless steel/Cromall® - Acier inoxydable/Cromall®  
Edelstahl/Cromall® - Acero inox/Cromall®  
Нержавеющая сталь/ Cromall®**FE35 G•FELCE**

61,5 x 26,2 x 14,4 cm

**Acciaio/Cromall®**Steel/Cromall® - Acier/Cromall®  
Stahl/Cromall® - Acero/Cromall®  
сталь/ Cromall®**FE44 G•FELCE**

61,5 x 26,2 x 5,6 cm

**Acciaio/Cromall®**Steel/Cromall® - Acier/Cromall®  
Stahl/Cromall® - Acero/Cromall®  
сталь/ Cromall®

# Maniglione G•Maldive

Realizzata in ottone e Cromall®

Made of brass and Cromall®

Réalisée en laiton et Cromall®

Hergestellt aus Messing und Cromall®

Realizada en latón et Cromall®

Изготовлено из латуни и Cromall®

13

Cromato  
Chromed

## A621-38

38 x 6,5 x 3 cm



## A621-50

50 x 6,5 x 3 cm



## A621-65

65 x 6,5 x 3 cm



## A622

56 x 6,5 x 22,8 cm



# Maniglioni G•Ascot

Maniglioni realizzati in acciaio inox , alluminio e Cromall®  
 Grab bars made of stainless steel, aluminum and Cromall®  
 Barres d'appui réalisées en acier inox, aluminium et Cromall®  
 Wannengriffe hergestellt aus Edelstahl, Aluminium und Cromall®  
 Asideros realizados en acero inox, aluminio y Cromall®  
 Поручень изготовлено из сталь, алюминия и Cromall®

Design: Carlo Vietri



13

ø 25 - sp.1 Cromato Chromed

## 2721 / 28

28,7 x 9,6 x 7,2 cm



## 2721 / 37

37,2 x 9,6 x 7,2 cm



## 2721 / 67

67,2 x 9,6 x 7,2 cm



## 2722

48,5 x 9,6 x 24,3 cm

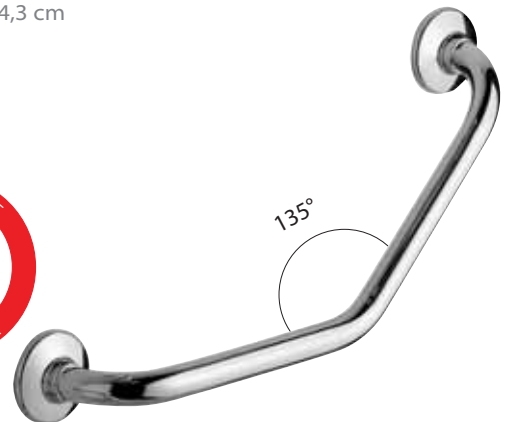
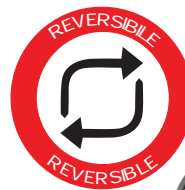

## 2720

48,5 x 13 x 24,3 cm



**con portasapone in filo reversibile in acciaio inox**  
 with reversible wire soap holder in stainless steel  
 avec porte savon fil réversible en acier inoxydable  
 mit umkehrbarer Stabseifenschale aus Edelstahl  
 con jabonera de varillas móvil en acero inox  
 с мьльницей с проволочным основанием  
 ие нержавеющей стали

# Maniglioni G•Edera

Maniglioni realizzati in acciaio inox e Cromall® - Grab bars made of stainless steel and Cromall®  
 Barres d'appui réalisées en acier inox et Cromall® - Wannengriffe hergestellt aus Edelstahl und Cromall®  
 Asideros realizados en acero inox y Cromall® - Поручень изготовлено из сталь и Cromall®

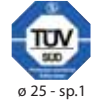

13  
 Cromato  
 Chromed

## ED21/28

26,9 x 9,6 x 8 cm

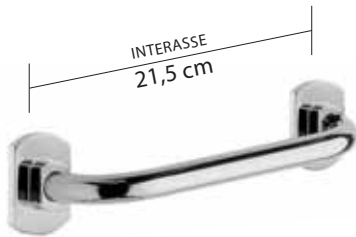

## ED21/37

35,4 x 9,6 x 8 cm

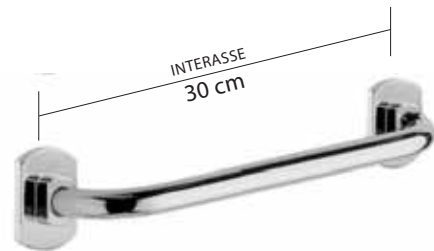

## ED22

46,8 x 9,6 x 25,2 cm

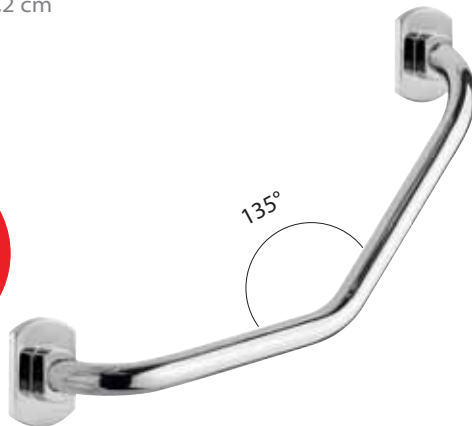

## ED20

46,8 x 13 x 25,2 cm

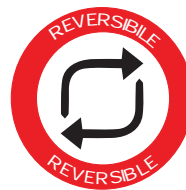

con portasapone in filo reversibile in acciaio inox  
 with reversible wire soap holder in stainless steel  
 avec porte savon fil réversible en acier inoxydable  
 mit umkehrbarer Stabseifenschale aus Edelstahl  
 con jabonera de varillas móvil en acero inox  
 с мыльницей с проволочным основанием из нержавеющей стали

# Filo stendibiancheria riavvolgibile

Retractable clothes line - Sèche linge retractable - Aufrollbarer Wäschetrockner - Tendedero enrollable ocultador  
 Выдвижная нить для сушки белья

## 2450 G•TULLO

∅ 9 x 6 cm

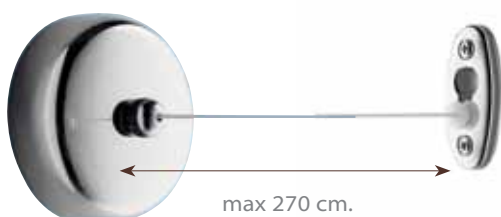

Acciaio inox  
 Stainless steel  
 Acier inoxydable  
 Acier inoxydable  
 Edelstahl  
 Acero inox  
 нержавеющая сталь

13  
 Lucido  
 Polished

# Materiale di consumo

Contract-sector range: refills - Collection pour hôtels et communautes: pièces de recharge  
 Contract-Sektor Sortiment: Nachfüllungsteile - Gama para hoteles y comunidades: piezas de recarga  
 Гамма для отелей: заполнение

100%  
made in Italy

00

\* 100% pura cellulosa - 100% pure cellulose - 100% pure cellulose  
 100% reine Zellulose - 100% celulosa pura - целлюлоза 100% чисто

2150

8,8 x 12 x 2,5 cm



## Sacchetti igienici in plastica

Plastic hygienic bags

Sachets hygiéniques en plastique

Abfallbeutel aus Kunststoff

Bolsitas higiénicas en plástica

Гигиенические пакеты

6 conf. da 25 pz.

6 boxes of 25 pcs/each

6 conf.de 25 pièces/chaque

6 Boxen von 25 St./jds

6 confecciones de 25 piezas/cada

6 коробок 25 частей

2151 \*

23 x 9,5 x 11 cm



## Salviette piegate a C - conf. da 150 pz.

Folded towels - box of 150 pcs

Petites serviettes pliées - confection de 150 pièces

Gefaltete kleine Tücher - Box von 150 St.

Toallitas dobladas - confección de 150 piezas

Сложенные салфетки - коробка 150 уастей

2152 \*

ø 22 x 11,5 cm



## Confezione 6 rotoli carta igienica a 2 veli per mini Jumbo m. 200 cad.

Package containing 6 rolls of toilet tissue (m.200/each)

Paquet 6 rouleaux papier hygiénique (m.200/chaque)

Packung mit 6 Rollen Toilettenpapier (m.200/jds)

Paquete 6 rollos papel higiénico (m.200/cada)

Упаковка из 6 рулонов туалетной бумаги (200 m.)

2153 \*

ø 31 x 11,5 cm



## Confezione 6 rotoli carta igienica a 2 veli per maxi Jumbo m. 500 cad.

Package containing 6 rolls of toilet tissue (m.500/each)

Paquet 6 rouleaux papier hygiénique (m.500/chaque)

Packung mit 6 Rollen Toilettenpapier (m.500/jds)

Paquete 6 rollos papel higiénico (m.500/cada)

Упаковка из 6 рулонов туалетной бумаги (500 m.)

2154 \*

41,5 x ø13 x 21 cm



## Confezione 3 rotoli carta asciugatutto - m.50 cad.

Package containing 3 rolls of paper towels (m.50/each)

Paquet 3 rouleaux papier essuie-tout (m.50/chaque)

Packung mit 3 Papierrollen (m.50/jds)

Paquete 3 rollos papel secante (m.50/cada)

Упаковка из 3 рулонов абсорбирующей бумаги (50 m.)

2156 \*

33 x 11,6 x 9,7 cm



## Confezione 3 mazzette da 300 fogli carta igienica intercalata

Package of 3 bundles of 300 sheets of toilet paper squares

Confection 3 lots de 300 feuilles papier toilette feuille a feuille

3er-packung mit 300 einzelblättern toilettenpapier

Paquete 3 juegos de 300 hojas de papel higiénico

Упаковка из 3 пачек по 300 листов туалетной бумаги





ø 32 mm



Cromato  
Chromed

100%  
made in Italy



# G•PRIMA CLASSE

**Programma in acciaio inox e nylon**

Program made of stainless steel and nylon - Programme en acier inoxydable et nylon

Programm aus Edelstahl und Nylon - Programa en acero inox y nylon

Программа из нержавеющей стали и нилон

Un disegno aggiornato e moderno, massima funzionalità, materiali di alta qualità e un sistema modulare: questo il nuovo programma PRIMA CLASSE. Il sistema di sedute è composto da un esclusivo sedile ribaltabile per la doccia e da uno sgabello in differenti varianti di colori (bianco, cromo/bianco e cromo/grigio). Il sistema di maniglioni è realizzato in acciaio inox in finitura lucida e completato con il maniglione di sostegno e l'appoggio ribaltabile, con o senza portarotolo, dalla forma moderna e chic.

A modern up-to-date design, absolute functionality, high-quality materials and modular construction system: those are the outstanding characteristics of the new PRIMA CLASSE program of safety grab bars. The seat system is composed by an exclusive tilt-up shower seat and a bath stool in different colour variants (white, chrome/white and chrome/grey). The handles are made of stainless steel in polished finishing and rounded off by the folding and support handle, with or without paper holder, in a modern and elegant design.

Modernes zeitgemäßes Design, absolute Funktionalität, hochwertige Materialien und modulares Baukastensystem: Diese sind die herausragenden Merkmale des Sitz- und Griffsystems PRIMA CLASSE. Das Sitzprogramm setzt sich aus einem exklusiven Duschklappsitz und einem Badehocker in verschiedenen Farbvarianten (weiß, chrom/weiß und chrom/grau) zusammen. Das Griffsystem besteht aus poliertem Edelstahl und abgerundet wird dieses Programm durch den Klapp- und Stützgriff, mit oder ohne Papierrollenhalter, mit einer modernen eleganten Form.

Un diseño moderno, materiales de alta calidad, funcionalidad absoluta y modularidad: este el nuevo programa de asientos y de asideros de seguridad PRIMA CLASSE. El sistema de asientos se compone de un exclusivo asiento móvil para ducha y de un taburete en diversas variantes de color (blanco, cromo/blanco y cromo/gris). El programa de asideros es realizado en acero inoxidable en acabado brillo y es completado por el asidero móvil, con o sin portarrollo y el asidero de apoyo, de forma moderna y elegante.

Un design actuel et moderne, une extrême fonctionnalité, des matériaux de haute qualité et un système modulaire: c'est la nouvelle collection PRIMA CLASSE. Le système de sièges est composé par un exclusif siège repliable pour la douche et par un tabouret en plusieurs couleurs (blanc, chromé/blanc et chromé/gris). Le système de barres est réalisé en acier inoxydable avec finition polie et complété par la barre d'appui et par la barre à abattant, avec ou sans porte papier, de forme moderne et chic.

Современная и обновленная конструкция, максимальная функциональность, высококачественные материалы и модульная система - все это новая программа "ПЕРВЫЙ КЛАСС". Система для сидения состоит из уникального откидного сиденья для душа и табурет различных цветов (белый, хромированный/белый и хромированный/серый). Система ручек изготовлена из нержавеющей стали с блестящей отделкой, дополнена поручнем и откидной ручкой с держателем для туалетной бумаги или без него в современном и шикарном стиле



## 6008

60 x 12,2 x 74,5 cm

**Specchio basculante infrangibile in acciaio inox**

Shatterproof tilting mirror in stainless steel  
 Miroir basculant infrangible en acier inox  
 Neigbarer bruchsicherer Spiegel aus Edelstahl  
 Espejo basculante irrompible de acero inoxidable  
 Поворотное зеркало небьющееся из нержавеющей стали

non certificato TÜV - Not TÜV certified - non certifié TÜV  
 Nicht TÜV-geprüft - no certificado TÜV  
 испытания на соответствие нормативу TÜV не проводились

13

Super  
Mirror

## 4942

23 x 13 x 7 cm



CE

IP 23

W75 - R7S

**Lampada alogena per specchio 6008  
ottone/vetro/resine termoplastiche**

Lamp with halogen light for mirror 6008  
 brass/glass/thermoplastic resins

Applique avec lampe halogène pour miroir 6008  
 laiton/verre/thermoplastique

Leuchte mit Halogenlampe für Spiegel 6008  
 Messing/Glas/Kunststoff

Aplique con lámpara para espejo 6008  
 latón/cristal/résinas termoplásticas

Чниверсальная галотенная лаппа для зеркала  
 6008 - латунь/стекло/термопластичная смола

## 6046

7,8 x 9,3 x 107,8 cm

**Sostegno per doccia con  
saliscendi**

Shower support with sliding rail  
 Barre pour douche avec système  
 de fixation ajustable  
 Duschstangenhalterung  
 Soporte para ducha con columna  
 Штанга для душа

## 6047

9,5 x 4,5 x 6 cm



08

Grigio  
Grey**Saliscendi - ABS**

Shower support - ABS  
 Fixation douche ajustable - ABS  
 Duschhalterung - ABS  
 Soporte para ducha - ABS  
 Подвижный/держатель  
 для душа - ABS



**6021/25**

A 25 cm

32,8 x 9,3 x 7,8 cm

**6021/45**

A 45 cm

52,8 x 9,3 x 7,8 cm

**6021/55**

A 55 cm

62,8 x 9,3 x 7,8 cm

**6021/65**

A 65 cm

72,8 x 9,3 x 7,8 cm

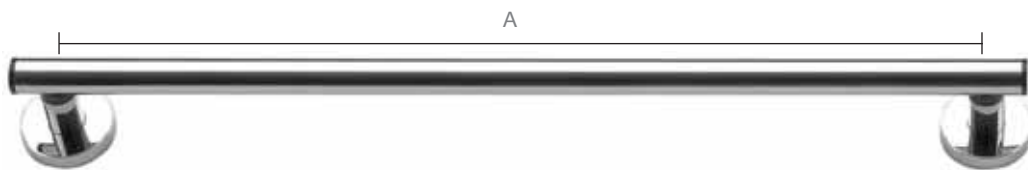
**6043/10**

112,8 x 9,3 x 7,8 cm

**6090/44**

66,5 x 9,3 x 51,5 cm

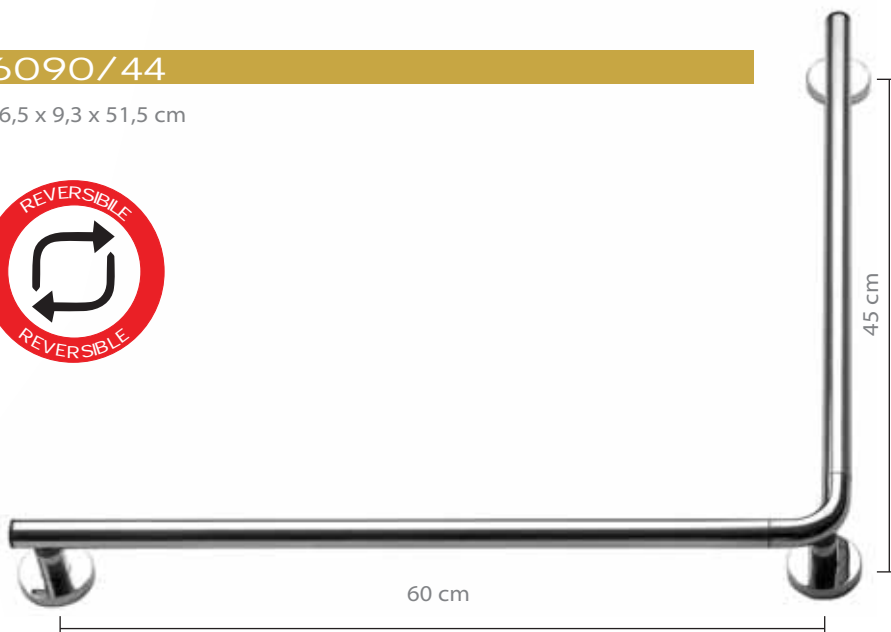

6057/65 ▲

10 x 65 x 28 cm

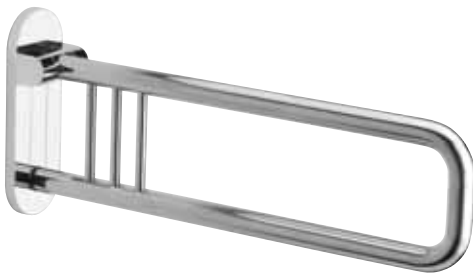

6057/75 ▲

10 x 75 x 28 cm

**Appoggio ribaltabile**

Safety folding handle - Barre à abattant

Klappgriff - Soporte móvil - Мобильный поручень

Design: Studio Talocci



- ▲ Meccanismo di ribaltamento in posizione orizzontale e verticale
- Collapsible mechanism in horizontal and vertical position
- Mécanisme de basculement en position horizontale et verticale
- Kippmechanismus in waagerechter und in senkrechter Position
- Mecanismo de abatimiento en posición horizontal y vertical
- Откидной механизм в вертикальном и горизонтальном положении

6059/65

10 x 65 x 28 cm

**Appoggio reversibile**

Reversible safety handle

Support réversible

Wandstützgriff umkehrbar

Soporte móvil - Обратимый

Design: Studio Talocci



6058/65 ▲

10 x 65 x 34 cm



6058/75 ▲

10 x 75 x 34 cm

**Appoggio ribaltabile con portarotolo**

Safety folding handle with paper holder - Barre à abattant avec porte

rouleau - Klappgriff mit Papierrollenhalter - Soporte móvil con portarrollo

Мобильный поручень с бумагодержателям

Design: Studio Talocci

non certificato TÜV - Not TÜV certified - non certifié TÜV

Nicht TÜV-geprüft - no certificado TÜV

испытания на соответствие нормативу TÜV не проводились

## 6083

35,5 x 37 x 10,5 cm

**Sedile ribaltabile per doccia - alluminio/ABS**

Shower seat - aluminium/ABS

Siège pour douche repliable - aluminium/ABS

Duschsitz hochklappbar - Aluminium/ABS

Asiento móvil para ducha - aluminio/ABS

Сиденье для душа - алюминий/ABS

Design: Studio Talocci

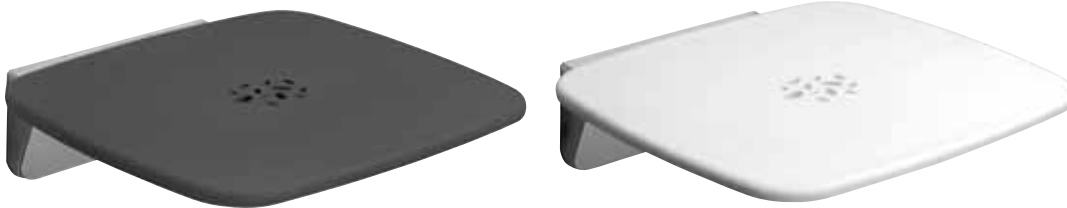
**02** Bianco  
White

**23** Bianco/cromo  
White/chromed

**43** Antracite/cromo  
Anthracite/chromed

— 4,8 —

non certificato TÜV - Not TÜV certified - non certifié TÜV  
Nicht TÜV-geprüft - no certificado TÜV  
испытания на соответствие нормативу TÜV не проводились

## 6072

40,9 x 33,1 x 43,8 cm

**Sgabello - alluminio/ABS**

Stool - aluminium/ABS

Tabouret - aluminium/ABS

Hoher - Aluminium/ABS

Taburete - aluminio/ABS

Табурет - алюминий/ABS

Design: Studio Talocci

**02** Bianco  
White

**23** Bianco/cromo  
White/chromed

**43** Antracite/cromo  
Anthracite/chromed

non certificato TÜV - Not TÜV certified - non certifié TÜV  
Nicht TÜV-geprüft - no certificado TÜV  
испытания на соответствие нормативу TÜV не проводились





ø 32 mm



100%  
made in Italy

G•SICURA

**Programma in alluminio e nylon**  
 Program made of aluminium and nylon  
 Programme en aluminium et nylon  
 Programm aus Aluminium und Nylon  
 Programa en aluminio y nylon  
 Програма из алюминий и нейлон

Un vastissimo programma di maniglioni e sistemi d'appoggio fissi e mobili in grado di soddisfare tutte le esigenze. Il sistema Sicura, messo a punto sulla base delle più recenti ricerche in tema di ergonomia, offre sicurezza e libertà dalle barriere architettoniche. Possibilità di inserimento nel settore della riabilitazione, casa di cura per anziani, nel campo dei sanitari, case private e strutture pubbliche. Copertura trattata con polveri speciali in resine epossidiche e poliestere, antiurto, antigraffio e non attaccabile dalle sostanze disinfettanti.

A very wide range of handles and fixed and movable supporting systems which will satisfy any requirements. The Sicura system, with designs based on the most recent research into ergonomics, offers safety and freedom from architectural barriers. Can be used in the sector of rehabilitation, residential homes for the elderly, in the sanitary-ware field, private houses and public buildings. Covering treated with special epoxy and polyester resins, shockproof, scratch-proof and resistant to attack by disinfectants.

Un très vaste éventail de poignées et de systèmes d'appui fixes et mobiles en mesure de satisfaire toutes les exigences. Le système Sicura, mis au point sur la base des plus récentes recherches en thème d'ergonomie, permet de surmonter en toute sécurité et liberté les barrières architectoniques. Possibilité de les placer dans le secteur de la rééducation, des maisons de santé pour personnes âgées, dans le domaine des sanitaires, des maisons privés et des structures publiques. Couverture traitée avec des poudres spéciales en résines époxy et polyester, antichoc, anti-égratignures et résistante aux substances désinfectantes.

Ein großes Angebot an Griffen, sowie festen und mobilen Stützsystemen, die allen Ansprüchen entsprechen. Das auf neusten ergonomischen Untersuchungen basierende Sicura System bietet Sicherheit und Unabhängigkeit von architektonischen Barrieren. Es kann für den Rehasektor, Altersheime, Sanitäreinrichtungen, Privathäuser und öffentliche Einrichtungen eingesetzt werden. Die mit Spezialpulver aus Epoxyd- und Polyesterharzen oberflächenbehandelte Serie aus Aluminium und Nylon ist schlagfest, kratzfest und gegen Desinfektionsmittel unempfindlich.

Un amplísimo programa de grilletes y de sistemas de apoyo fijos y de muebles capaces de satisfacer todas las exigencias. El sistema Sicura, puesto a punto basándose en las más recientes investigaciones en tema de ergonomía, ofrece seguridad y libertad de las barreras arquitectónicas. Posibilidad de introducción en el sector de la rehabilitación, en las clínicas para ancianos, en el campo de los sanitarios, en las casas privadas y en las estructuras públicas. Revestimiento tratado con polvos especiales de resinas epoxídicas y poliéster, antichoque, irrayable y no atacable por las sustancias desinfectantes.

Предлагаем широкий ассортимент поручней и опорных приспособлений, как съёмных, так и стационарных, отвечающих самым разнообразным требованиям. Система Sicura, разработанная с учётом последних достижений в области эргономики, обеспечивает безопасность при отсутствии капитальных ограждений. Она предназначена для использования в больничных и реабилитационных учреждениях, домах престарелых, жилых домах и помещениях общего пользования. При изготовлении используется алюминий и нейлон, а также покрытия, обработанные специальными эпоксидными и полиэфирными порошками, устойчивыми к механическим и химическим воздействиям.



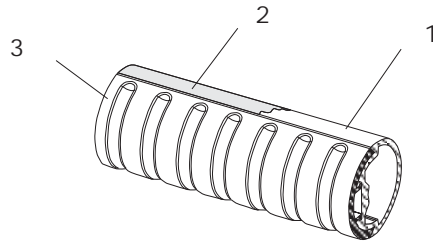

### I 1 COPERTURA

- Trattata con polveri speciali in resine epossidiche e poliesteri
- Antiurto, antigraffio e non attaccabile dalle sostanze disinfettanti

### 2 PROFILO

- Profilo in lega speciale di alluminio-silicio-magnesio con eccellenti proprietà meccaniche
- Altissima resistenza alla corrosione, ecc.

### 3 NYLON

- Nylon è un termine commerciale per il poliammide. Il materiale possiede qualità tali da renderlo adatto anche per la realizzazione di componenti tecniche. Viene dunque preferito per le sue proprietà e cioè:
- resistenza alle rotture
- resistenza all'abrasione
- resistenza alle alte temperature
- resistenza ai solventi ed ai prodotti chimici

### D 1 ABDECKUNG

- Mit Spezialpulver aus Epoxyharze und Polyester behandelt
- Schlagfest, kratzfest und unempfindlich gegen Desinfektionsmittel

### 2 PROFIL

- Profil aus Aluminium-Silizium-Magnesium-Legierung mit hervorragenden mechanischen Eigenschaften
- Extrem korrosionsfest

### 3 NYLON

- Nylon ist eine Handelsbezeichnung für Polyamid. Das Material besitzt Charakteristiken, die es zur Herstellung technischer Komponenten geeignet machen. Es wird wegen folgender Eigenschaften bevorzugt:
- bruchfest
- verschleißfest
- temperaturunempfindlich
- unempfindlich gegen Lösungsmittel und chemische Erzeugnisse

### GB 1 COVERING

- treated with special epoxy resin and polyester powders
- shockproof, scratch-proof and resistant to disinfectants

### 2 PROFILE

- Profile in special aluminium-silicon-magnesium alloy with excellent mechanical properties
- very high resistance to corrosion

### 3 NYLON

- Nylon is a commercial term for polyamide. This material has qualities that make it suitable for producing technical components. It is therefore preferred because of its properties, i.e.:
- resistance to breaking
- resistance to abrasions
- resistance to high temperatures
- resistance to solvents and chemicals

### E 1 REVESTIMIENTO

- tratado con polvos especiales de resinas epoxídicas y poliéster
- antichoque, resistente al rayado y no atacable por las sustancias desinfectantes

### 2 PERFIL

- Perfil de aleación especial de aluminio-silicio-magnesio con excelentes propiedades mecánicas
- altísima resistencia a la corrosión

### 3 NYLON

- Nylon es un término comercial para la poliamida. El material posee calidades que hacen que sea adecuado también para la realización de componentes técnicos. Por lo tanto se prefiere por sus propiedades, es decir:
- resistencia a las rupturas
- resistencia a la abrasión
- resistencia a las altas temperaturas
- resistencia a los solventes y a los productos químicos

### F 1 COUVERTURE

- traité avec poudres spécifiques de résines époxydiques et polyester
- antichoc, antirayures et entièrement résistant aux produits désinfectants

### 2 PROFIL

- Profil en alliage spécial aluminium-silicium-magnésium offrant d'excellentes propriétés mécaniques
- très haute résistance à la corrosion

### 3 NYLON

- Nylon est l'appellation commerciale du polyamide. Ce matériau possède des qualités lui permettant d'être utilisé pour la réalisation des composants techniques:
- résistance à la rupture
- résistance à l'abrasion
- résistance aux hautes températures
- résistance aux solvants et aux produits chimiques

### R 1 ПОКРЫТИЕ

- обработано специальными порошками из эпоксидных смол и полиэфира
- противоударное, защищенное от царапин и не повреждаемое дезинфицирующими средствами

### 2 ПРОФИЛЬ

- профиль из специального сплава алюминия-кремния-магния с прекрасными механическими свойствами
- высочайшая устойчивость к коррозии

### 3 НЕЙЛОН

- Нейлон – это коммерческий термин для обозначения полиамида. Этот материал обладает качествами, делающими его пригодным для изготовления технических компонентов. Его использование предпочтительно благодаря его свойствам:
- устойчивость к поломкам
- устойчивость к абразивному износу
- устойчивость к высоким температурам
- устойчивость к растворителям и химическим веществам

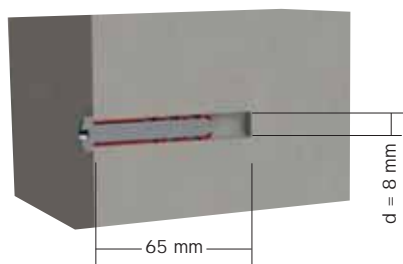

① FISSAGGIO STANDARD

I seguenti accessori, adatti per il montaggio standard, sono inclusi:

- Tassello in nylon BF 8
- Vite da legno 5,5 x 50 din 7981 - UNI 6954

adatta per calcestruzzo, mattoni pieni, mattoni forati  
Per pareti non comprese nelle tipologie sopraelencate, rivolgersi ad una ditta specializzata.

ⓐ STANDARD FIXING

The following accessories, suitable for standing mounting, are included:

- 8 - BF nylon wall plugs
- 5 - Wood screws - 5,5x50 din 7981 - UNI 6954 suitable for concrete, solid brick, hollow bricks, plasterboard

For walls not included in the types listed above, apply to a specialist company.

ⓓ FIXATION STANDARD

Les accessoires suivants, prévus pour un montage standard, sont inclus dans la fourniture:

- cheville en nylon BF 8
- vis en bois 5,5x50 DIN 7981 - UNI 6954 prévue pour béton, briques pleines, briques perforées, placoplâtre

En ce qui concerne les types de murs non énumérés plus haut, prière de s'adresser à une entreprise spécialisée.

ⓓ STANDARDBEFESTIGUNG

Folgende für eine Standardmontage erforderliche Komponenten sind inbegriffen:

- Nyldübel BF 8
- Holzschraube 5,5x50 DIN 7981 - UNI 6954 geeignet für Beton, Vollstein, Hohlstein, Rigips-Platten

Für oben nicht aufgeführte Wandtypen ist sich an einen Fachbetrieb zu wenden

ⓔ FIJACIÓN ESTÁNDAR

Están incluidos los siguientes accesorios, aptos para el montaje estándar:

- taco de nylon BF 8
- tornillo de madera 5,5x50 din 7981 - UNI 6954 apto para hormigón, ladrillos llenos, ladrillos huecos, cartontabla

Para paredes no incluidas en las tipologías aquí arriba mencionadas, dirigirse a una empresa especializada

ⓓ СТАНДАРТНАЯ ФИКСАЦИЯ

Включены следующие принадлежности, подходящие для стандартного монтажа:

- нейлоновая пробка BF 8
- винт для дерева 5,5x50 din 7981 - UNI 6954, подходящий для бетон, полнотелые кирпичи, пустотелые кирпичи, гипсокартон.

Для стен, не включенных в данные типологии, указанные выше, следует обращаться в специализированную организацию

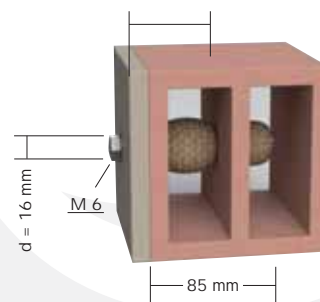

① FISSAGGIO SPECIALE

Gli accessori sottoelencati per il fissaggio speciale

- devono essere acquistati in un negozio specializzato:
- ancorante chimico ad iniezione, mod. Fischer FIP 16
- vite esagonale M 6 x 20 DIN 931 CNS

Adatto per il fissaggio alle seguenti pareti:

- mattoni forati
- mattoni in agglomerato precompresso
- mattoni pieni

ⓐ SPECIAL FIXING

The accessories listed below must be purchased in a specialist sales outlet:

- chemical hanger for injection, mod. Fischer FIP 16
- hexagonal screws M 6x20 din 931 CNS

Suitable for fixing to the following walls:

- hollow brick
- pre-compressed briquette
- solid brick

ⓓ FIXATION SPÉCIALE

Les accessoires ci-dessous doivent être achetés dans un magasin spécialisé :

- agent d'ancrage chimique à injection, mod. Fischer FIP 16
- vis hexagonale M 6x20 DIN 931 CNS

Prévu pour fixation aux types de murs suivants :

- briques perforées
- briques en aggloméré précontraint
- briques pleines

ⓓ SPEZIALBEFESTIGUNG

Das unten aufgeführte Material ist im Fachhandel erhältlich:

- Injektionsverankerung, Mod. Fischer FIP 16
- Sechskantschraube M 6x20 DIN 931 CNS

Für die Befestigung an folgenden Wänden geeignet:

- Hohlstein
- Porenbeton
- Vollstein

ⓔ FIJACIÓN ESPECIAL

Los accesorios indicados aquí abajo tienen que ser comprados en una tienda especializada:

- fijador químico de inyección, mod. Fischer FIP 16
- tornillo exagonal M 6x20 din 931 CNS

Apto para la fijación a las siguientes paredes:

- ladrillos huecos
- ladrillos de aglomerado pre-comprimido
- ladrillos llenos

ⓓ СПЕЦИАЛЬНЫЙ КРЕПЕЖ

Перечисленные ниже принадлежности должны быть приобретены в специализированном магазине:

- химический впрыскиваемый закрепитель, мод. Fischer FIP 16
- шестигранный винт M 6x20 din 931 CNS

подходит для фиксации на следующие стены:

- полнотелые кирпичи
- кирпичи из восстановленного агломерата
- дырчатые кирпичи

## 4800

60 x 18 x 70 cm

**Specchio basculante infrangibile  
in resine termoplastiche/nylon**

Shatterproof tilting mirror in thermoplastic resins/nylon

Miroir basculant infrangible en thermoplastique/nylon

Neigbarer bruchsicherer Spiegel aus Kunststoff/nylon

Espejo basculante irrompible de resinas termoplásticas/nylon

Поворотное зеркало небьющееся

из термопластичных смол и нейлона

non certificato TÜV - Not TÜV certified - non certifié TÜV

Nicht TÜV-geprüft - no certificado TÜV

испытания на соответствие нормативу TÜV не проводились

## 4942

23 x 13 x 7 cm



CE

IP 23

W75 - R7S

**Lampada alogena per specchio 4800  
ottone/vetro/resine termoplastiche**Lamp with halogen light for mirror 4800  
brass/glass/thermoplastic resinsApplique avec lampe halogène pour miroir 4800  
laiton/verre/thermoplastiqueLeuchte mit Halogenlampe für Spiegel 4800  
Messing/Glas/KunststoffAplique con lámpara para espejo 4800  
latón/cristal/resinas termoplásticasЧниверсальная галотенная лаппа для зеркал 4800  
латунь/стекло/ термопластичная смоль

## 4840/25\*

A 25 cm  
30 x 9 x 8 cm

## 4840/45

A 45 cm  
53 x 9 x 8 cm

## 4841/55

A 55 cm  
63 x 9 x 8 cm

## 4842/65

A 65 cm  
73 x 9 x 8 cm

Maniglioni antiscivolo, con superfici prive di angoli -  
Non-slip handles, with smooth, rounded surfaces - Poignées  
antidérapantes, avec surfaces sans arêtes - Elemente  
mit rutschfesten Griffen und kantenlosen Oberflächen  
Grilletes antideslizantes, con superficies sin ángulos -  
Нескользкие поручни с округлой поверхностью

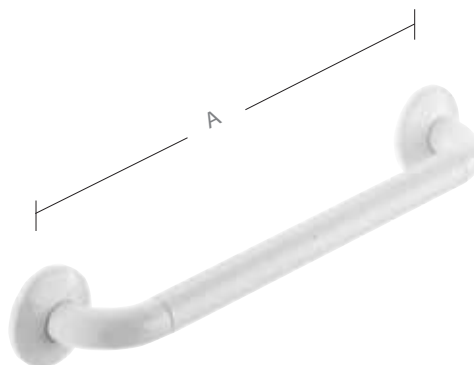

\* Articolo disponibile su richiesta - Item available on request  
Article disponible sur demande - Auf Anfrage erhältlich Artikel  
Artículo disponible bajo petición - Продукция, изготавливаемая  
по заказу

**4843/10**

A 105 cm

113 x 9 x 8 cm

**4844/11 \***

A 115 cm

123 x 9 x 8 cm

**4848/44**

A 45,5 cm

B 60,5 cm

52 x 9 x 67 cm

**4849/44 \***

A 45,5 cm

B 70,5 cm

52 x 9 x 77 cm

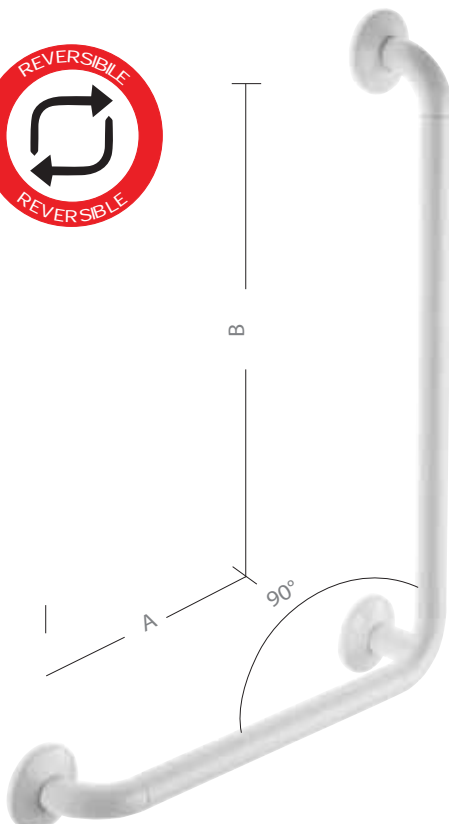

\* Articolo disponibile su richiesta - Item available on request  
 Article disponible sur demande - Auf Anfrage erhältlich Artikel  
 Artículo disponible bajo petición - Продукция, изготавливаемая по заказу



**4854/77\***

A 77 cm

B 77 cm

81 x 81 x 9 cm

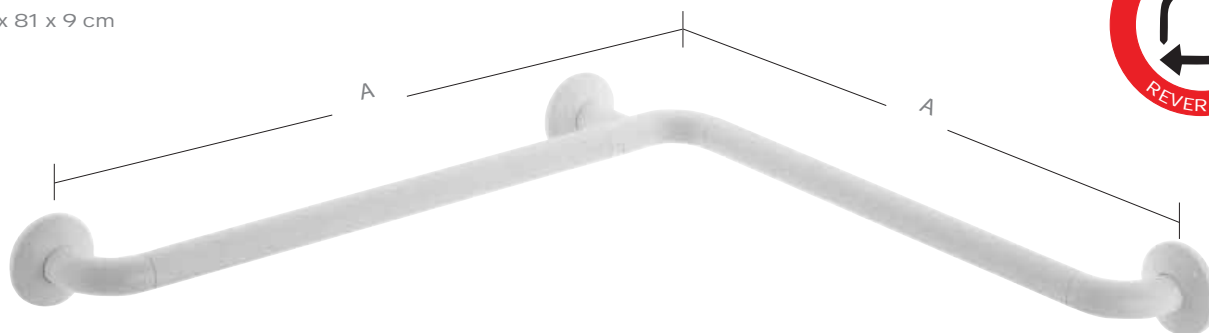
**4857/64**

A 64 x 9 x 18 cm

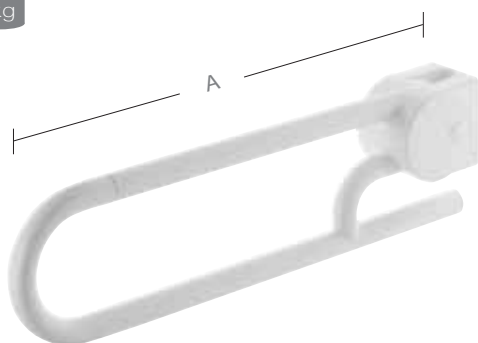
**4858/74**

A 74 x 9 x 18 cm

**4859/64**

A 64 x 24 x 18 cm

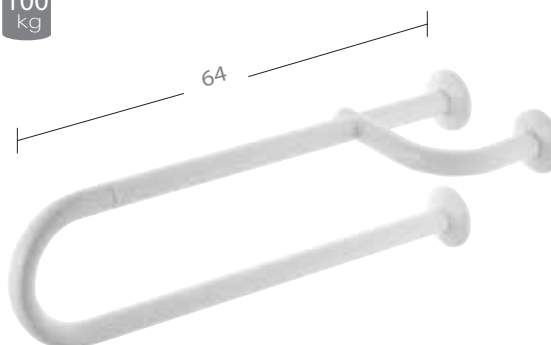
**Meccanismo di ribaltamento in posizione orizzontale e verticale**

Collapsible mechanism in horizontal and vertical position

Mécanisme de basculement en position horizontale et verticale

Kippmechanismus in waagerechter und in senkrechter Position

Mecanismo de abatimiento en posición horizontal y vertical

Откидной механизм в вертикальном и горизонтальном положении

**Reversibile**

Reversible

Réversible

Reversibler

Reversible

Обратимый

\* Articolo disponibile su richiesta - Item available on request  
 Article disponible sur demande - Auf Anfrage erhältlich Artikel  
 Artículo disponible bajo petición - Продукция, изготавливаемая по заказу

**4863 \***

23 x 14,5 x 60,5 cm

**Maniglione per vasca. Adattabile a vasche con bordo da 6 cm a 12,5 cm**

Safety handle for bath. Adaptable for bath-tubs with rims from 6 cm to 12,5 cm

Barre de sûreté pour baignoire. Adaptable à baignoires avec bord de 6 cm à 12,5 cm

Wanneneinsteighilfe. Verwendbar für Wannen mit einer Wandstärke von 6 cm bis 12,5 cm

Asidero para bañera. Adaptable a bañeras con borde de 6 cm a 12,5 cm

Двойной поручень на ванну. Устанавливается на ванны, имеющие стенку от 6 до 12,5 см

**4880**

9 x 9 x 8 cm

**Angolo 90°**

Angle 90° - Angle 90°

Winkel 90° - Angulo 90°

Угол 90°

**4881**

11 x 9 x 8 cm

**Angolo a T**

T-Angle - Angle a T

T-Winkel - Angulo a T

Угол в форме T

**4882**

13 x 9 x 9 cm

**Angolo 145° con piede**

Angle 145° with foot

Angle 145° avec pied

Winkel 145° mit Fuß

Angulo 145° con patas

Угол 145° с ножкой

**4883**

15 x 9 x 9 cm

**Angolo 90° con piede**

Angle 90° with foot

Angle 90° avec pied

Winkel 90° mit Fuß

Angulo 90° con patas

Угол 90° с ножкой

**4884**

15 x 9 x 8 cm

**Supporto con angolo 90°**

Support with angle 90°

Support avec angle 90°

Befestigung mit Winkel 90°

Soporte con angulo 90°

Опора с углом 90°



4885 35

4885 45

4885 50

4885 55

4885 60

A 35 cm

A 45 cm

A 50 cm

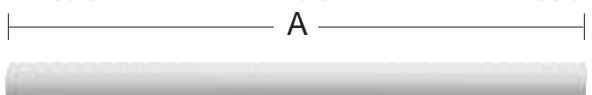

A 55 cm

A 60 cm

**Profilo anatomico** - Profile tube with finger groove

Profil anatomique - Profilrohr mit Fingerrillen

Perfil aluminio con antideslizante - Анатомический профиль

① Non certificato TÜV - Not TÜV certified - Non certifié TÜV  
Nicht TÜV-geprüft - No certificado TÜV - Испытания  
на соответствие нормативу TÜV не проводились

2283

34,5 x 34,5 x 10,5 cm



**Sedile ribaltabile per doccia  
resine termoplastiche/alluminio**

Shower seat - thermoplastic resins/aluminium

Siège pour douche repliable - thermoplastique/aluminium

Duschsitz hochklappbar - Kunststoff/Aluminium

Asiento móvil para ducha - resinas termoplásticas/aluminio

Сиденье для душа - термопластичные смолы/алюминий

2284 ①

64 x 32,4 x 18,3 cm

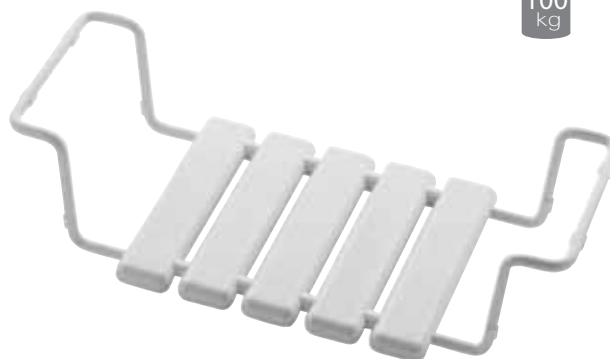

**Sedile estensibile per vasca  
resine termoplastiche/alluminio**

Bath tub seat - thermoplastic resins/aluminium

Siège pour baignoire - thermoplastique/aluminium

Badewannensitz - Kunststoff/Aluminium

Asiento para bañera - resinas termoplásticas/aluminio

Раскладное сиденье для ванной  
термопластичные смолы/алюминий

Braccioli estensibili per vasche con misura interna di 50-65 cm

Extendable arms for baths with internal measurement 50-65 cm

Bras extensibles pour baignoires aux dimensions intérieures de 50-65 cm

Verlängerbare Armlehnen für Wannen mit einem Innenmaß von 50-65 cm

Аройабразос extensibles para bañeras con medidas interiores de 50-65 cm

Выдвижные поручни для ванны, имеющей внутреннюю ширину от  
50 до 65 см

4896\* ①

43,8 x 51,4 x 60,1 cm



**Sedile con seduta liscia ergonomica agganciabile a maniglione**

Hanging smooth shower seat for grab bar system

Siège pour douche avec assise lisse, accrochable à barre d'appui

Einhängesitz für Grifffsystem mit glatter Sitzfläche

Asiento colgado para ducha con silla lisa ergonómica por el sistema de  
asideros

Сиденье с гладкой поверхностью, прицепляемое к рукоятке

\* Articolo disponibile su richiesta - Item available on request

Article disponible sur demande - Auf Anfrage erhältlich Artikel

Artículo disponible bajo petición - Продукция, изготавливаемая по заказу

Programma di maniglioni e sistemi d'appoggio fissi e mobili realizzato in acciaio zincato con verniciatura con polveri speciali in resine epossidiche e poliestere e attacchi in Ultraform®.

Range of handles and fixed and movable supporting systems made of zincated steel with covering treated with special epoxy and polyester resins and wall plates in Ultraform®.

Programme de poignées et de systèmes d'appui fixes et mobiles, réalisé en acier zingué avec laquage traité avec des poudres spéciales en résines époxy et polyester et plaques à mur en Ultraform®.

Serie von Griffen, sowie festen und mobilen Stützsystemen, hergestellt aus mit Spezialpulver aus Epoxyd- und Polyesterharzen oberflächenbehandeltem verzinkten Stahl mit Wandbefestigungen aus Ultraform®.

Programa de grilletes y de sistemas de apoyo fijos y de muebles realizado en acero galvanizado con revestimiento tratado con polvos especiales de resinas epoxídicas y poliéster y placas de pared en Ultraform®.

Ассортимент поручней и опорных приспособлений, как съёмных, так и стационарных, изготовлено из оцинковыванной стали, а также покрытия, обработанные специальными эпоксидными и полиэфирными порошками и с плитами стены в Ultraform®.



**6421/30**

37,5 x 11 x 7,5 cm - A=30

**6421/45**

52,5 x 11 x 7,5 cm - A=45

**6421/60**

67,5 x 11 x 7,5 cm - A=60

**6421/90**

97,5 x 11 x 7,5 cm - A=90

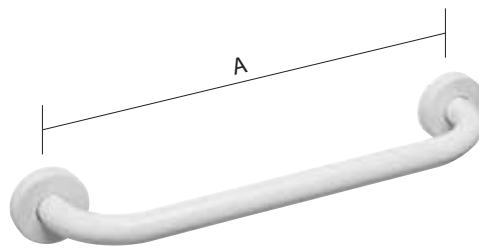
**6490/00**

A 36 x B 65 x 11 cm

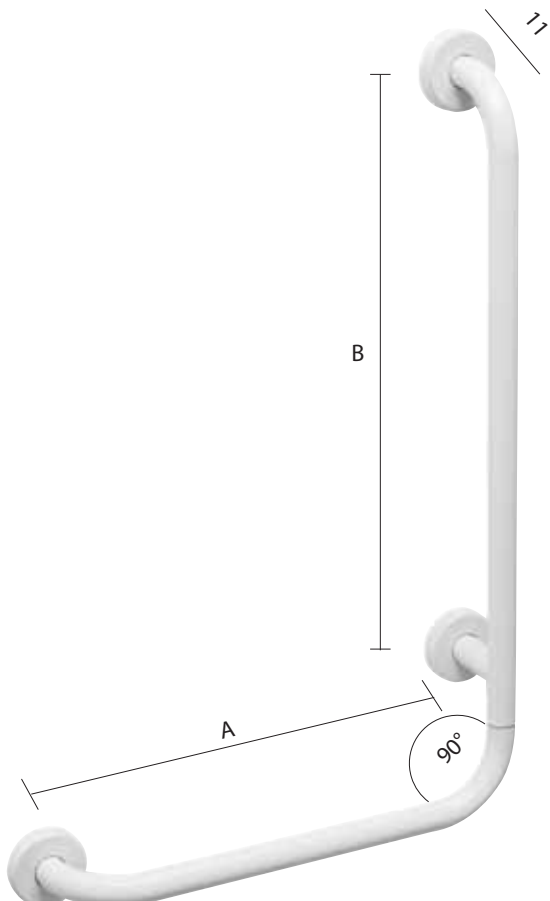
**6490/01**

A 36 x B 65 x 11 cm

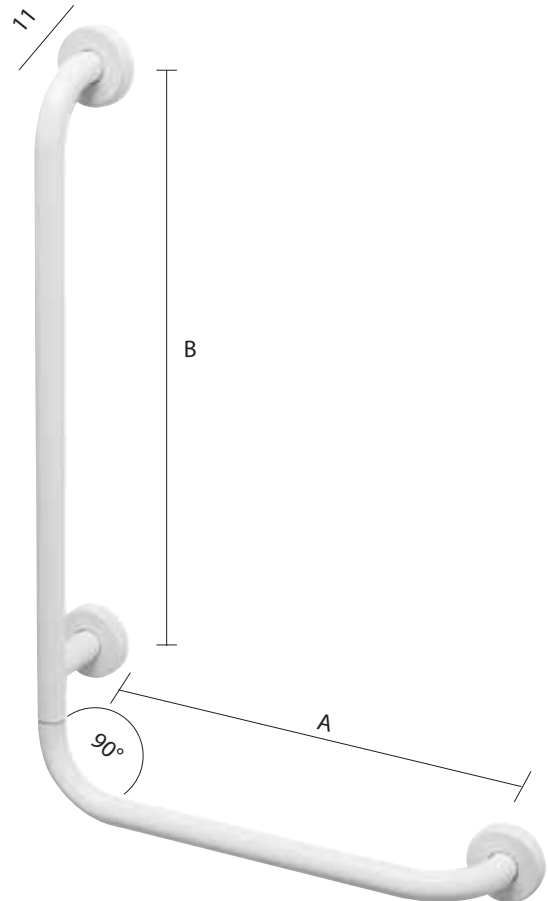



6445

58,5 x 11 x 39 cm

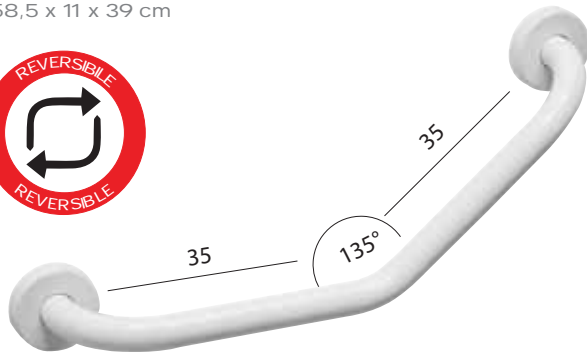

6450

7,5 x 16,5 x 187,5 cm



6466\*

8,5 x 67 x 25 cm

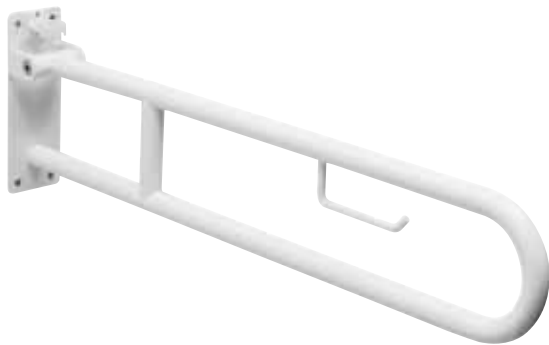

6465\*

8,5 x 67 x 25 cm

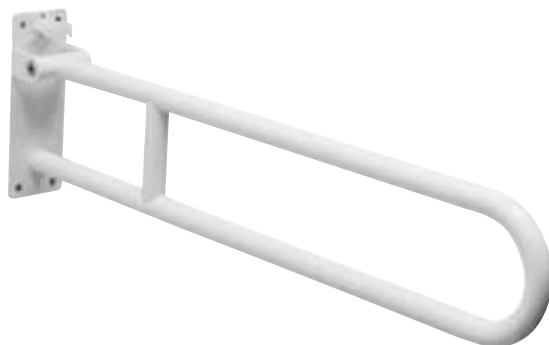

\* **Meccanismo di ribaltamento in posizione orizzontale e verticale**

Collapsible mechanism in horizontal and vertical position

Mécanisme de basculement en position horizontale et verticale

Kippmechanismus in waagerechter und in senkrechter Position

Mecanismo de abatimiento en posición horizontal y vertical

Откидной механизм в вертикальном и горизонтальном положении



Gedy S.p.A.  
Via dell'Industria, 6  
21040 Origgio (VA) - Italia  
Tel. +39.02.96.95.01  
Fax +39.02.96.73.43.01  
[www.gedy.com](http://www.gedy.com) - [info@gedy.com](mailto:info@gedy.com)

