

loomma

STEP BEYOND

BOMMA STORY

BOMMA is a modern dynamic glass-lighting producer based in the Czech Republic, a glassmaking hub with centuries of tradition. However, many stars had to align for this young company's fast rise to worldwide recognition in the interior design field. BOMMA brought together an unusual blend of vision, talent, craft, technical know-how and passion, all at a particular moment in time.

Beginnings

In 1992, Jiří Trtík founded *Bohemia Machine* - a company focused on developing advanced in-house glass technologies, particularly automated machines for robotic cutting. The post-communist economic turmoil affected traditional glassmaking centers, including *Bohemia Machine's* region of Světlá nad Sázavou. Many large factories failed to adapt to changed market conditions. Thus this new and progressive company began attracting much of the industry's best talent, many from families with generations of glassmakers.

In 2016, BOMMA was launched as a brand specializing in the original design and manufacture of modern glass lighting. Unlike its parent company, BOMMA is solely focused on hand-production that preserves traditional craftsmanship. Even so, it supports its craftsmen with high-precision technical know-how, a company-culture of innovation and collaboration, as well as the chance to work with top-quality materials in ultra-modern facilities.

Next-Level Craft

Martin Wichterle, the owner of BOMMA, explains, *"Every manager says they are proud of their team, and all glassmaking is fascinating to watch. But seeing our craftsmen handle oversized pieces or cut glass with extreme precision is an otherworldly experience. You never get used to it."*

BOMMA quickly became known for producing hand-blown glass lighting in monumental sizes. Due to the craft's complexity and physical demands, only a few such large-scale pieces are produced each day. Individual crystal products are then handled by various experienced craftsmen, each shaping them closer to the desired perfection.

Collections and Collaborations

This spirit of creativity, courage and innovation is now visible in lighting collections that incorporate unconventional materials, daring colors, and the latest industry-wide technological advancements. Enabled by continual investment, BOMMA's current glassworks in Světlá nad Sázavou, Czech Republic, is among the most modern facilities in Europe, leveraging its proprietary technologies.

These unique production capabilities, specialized talent and open approaches attracted both local and international architects and designers. BOMMA also continues to create bespoke products for renowned luxury brands, as well as components that have proven too demanding for other glassworks. Special projects challenge BOMMA's collaborative designers, craftsmen and technicians to push the boundaries of what is possible.













COLLECTIONS

Dew Drops
Lantern
Pyrite
Shibari
Soap Mini
Lens
Umbra
Tim
Dark & Bright Star
Pebbles
Tied-Up Romance
Orbital
Pendulum
Soap
Disc
Blimp
Phenomena

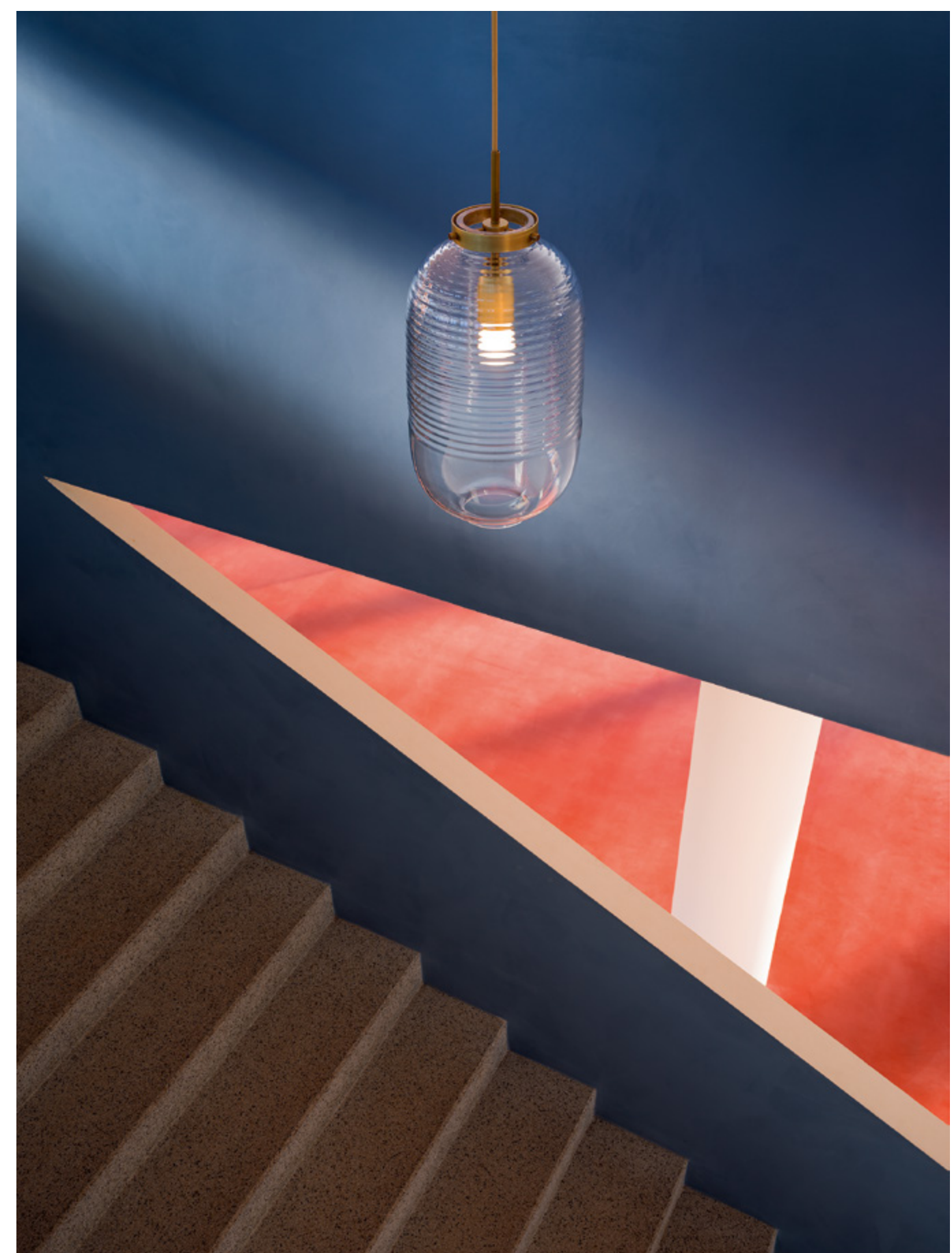

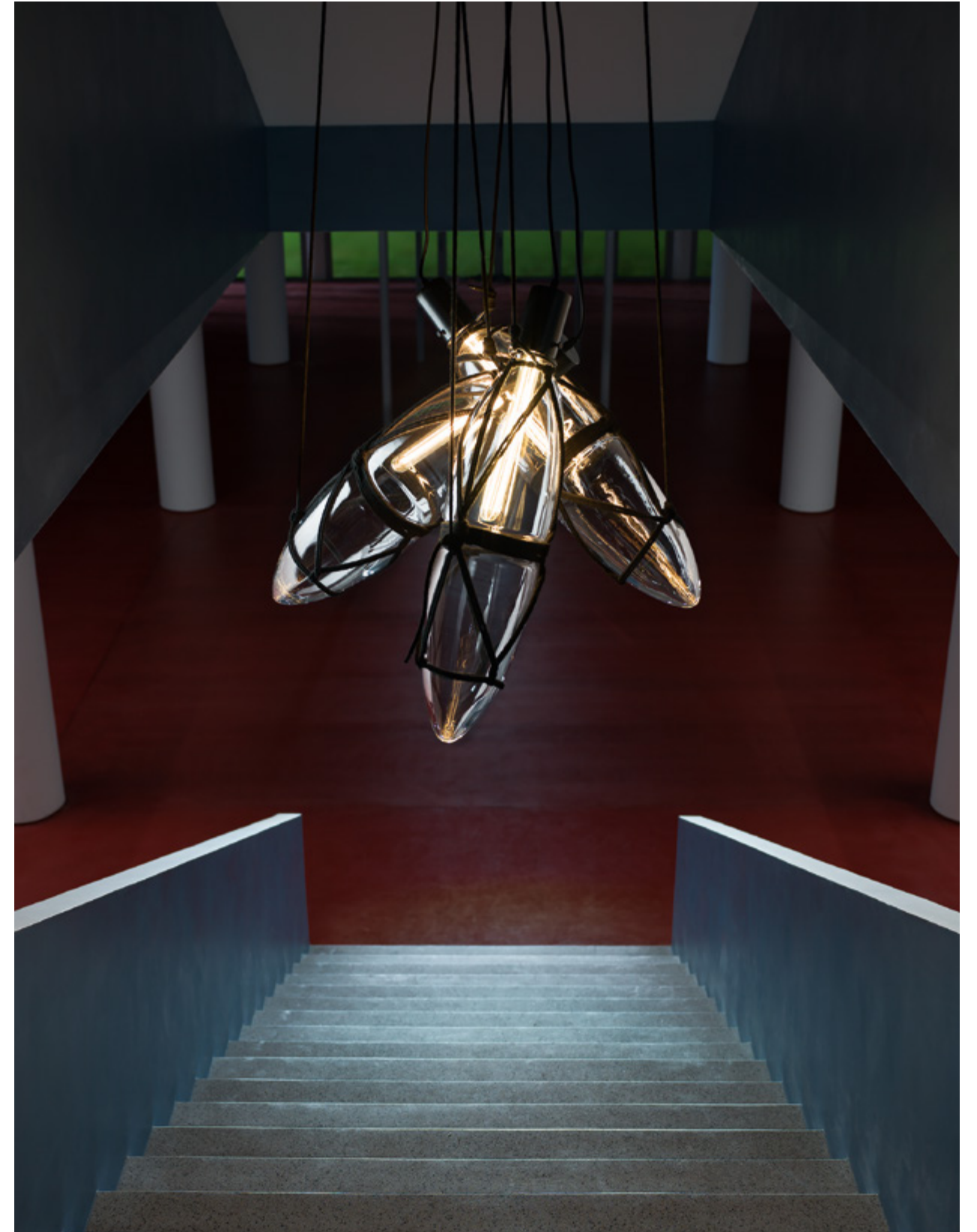







Dark & Bright Star p. 82

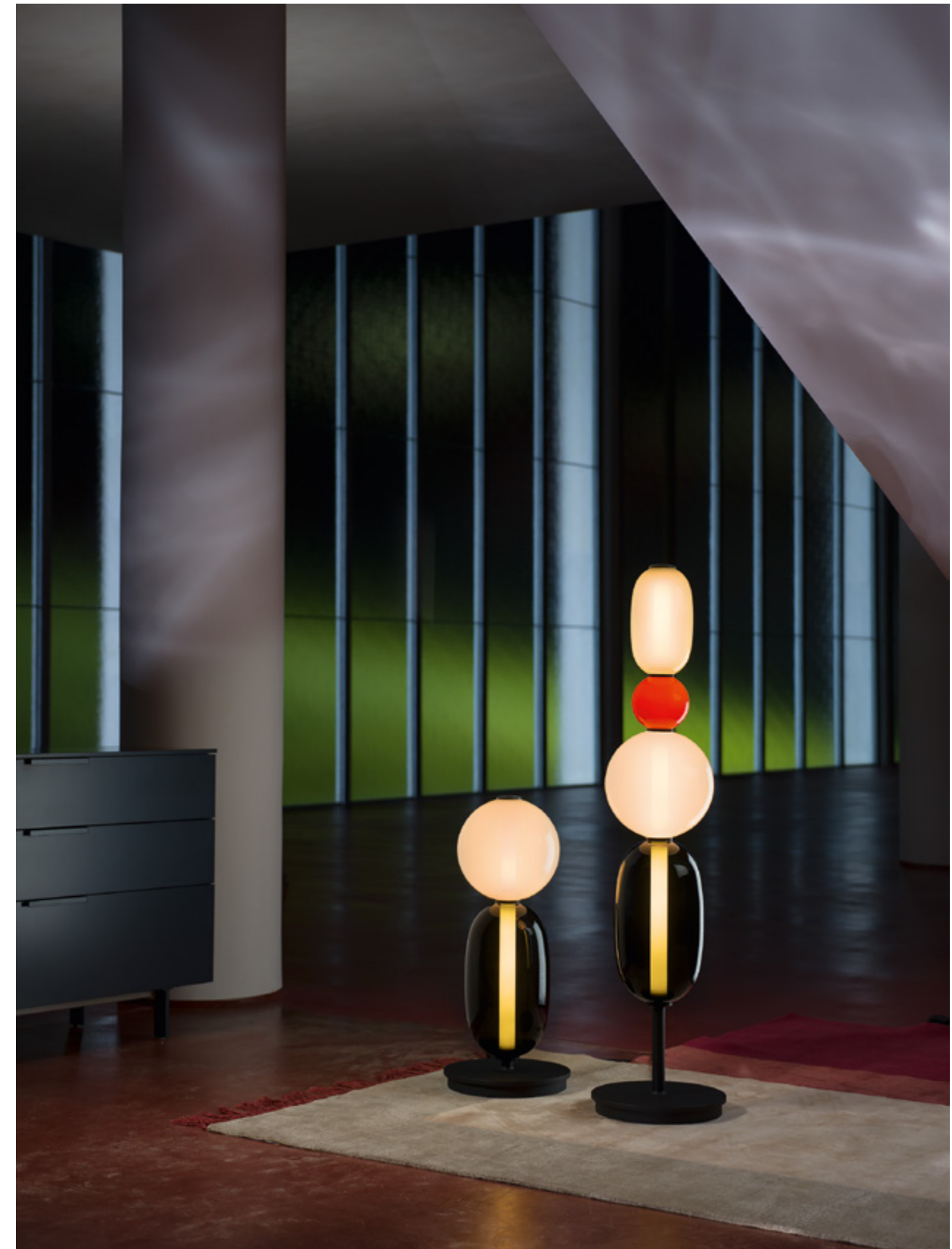

Pebbles p. 88









STEP BEYOND

BOMMA consistently pushes the boundaries of glassmaking beyond expected limits, dancing on the edge of what is humanly and technically possible. From free-form blowing of oversized pieces to extremely precise glass cutting, our team thrives on innovation and welcomes challenge. We invite you to step beyond your expectations of design, craft and technical skill.

This catalog presents our lighting collections for private and public interiors. From small to oversized, BOMMA products are designed to bring emotion, delight and beauty to traditional and modern spaces. These products impress through their inventiveness, quality and, often, their improbable size.

Several collections are specifically designed to enable an easy gathering of individual lighting elements into groups that best suit your interiors and aesthetic intent. Create your own BOMMA Constellation that will light up a corner of a room, serve as a centerpiece or fill an entire space. We welcome collaborations with architects and designers worldwide to meet specific requirements, whether by adapting existing pieces or creating a bespoke design just for your special purposes.

Although we take pride in our own product line, we continue to manufacture custom glass for renowned brands, as well as designers or other glassmakers in need of specialized components. At your direction, we can easily *step beyond* the realm of glass lighting and produce crystal vases for limousine interiors or luxury liqueur bottles. Within BOMMA's state-of-the-art facilities, skilled designers, exceptionally gifted craftsmen and reliable technicians can participate in bringing your ideas into practical reality.



Dew Drops

by Boris Klimek

NATURE'S GEMS ON BLADES OF GRASS

Dew drops sparkling on a thin blade of grass expose the elemental beauty of nature that continues to fascinate us. The intimately familiar, yet still charming, shape of dew drops inspired this collection with its precise details. Lit by an internal light source offering an exceptional esthetic experience, the crystal objects show hints of iridescence. They adhere tightly to hand-sewn bands from handcrafted leather or an innovative vegan leather. The BOMMA Dew Drops Collection will surprise you with its variable installation possibilities and the option to create unique compositions in space. The result is always a distinct and artistic installation, the centerpiece gleaming from every angle of an interior.







Lantern

by Jan Plecháč & Henry Wielgus

WHEN GLASS EMBODIES PAPER

The ancient shape of the lantern, transformed by BOMMA and recast into glass, maintains its age-old symbolism of a messenger. The essential shape of the crystal Chinese lantern is replicated by hand-blowing into a wooden form. The resulting precise craft, despite its minimalist appearance, accentuates our prime devotion to traditional glassmaking principles in both top quality and perfect details. In their basic clear version, these lighting objects can be easily combined, forming random or even geometric groups. In smoke or white colors, Lantern adds soft ambient light to any interior.







Pyrite

by Dechem Studio

THE FIERY STONE FROM THE CORE OF THE EARTH

The sculptural structures of minerals and their perfectly smooth surfaces are among the most precious treasures from the very core of the Earth, only revealing their optical magic once they encounter a source of light. This BOMMA collection was inspired by pyrite, the golden fire-stone in the shape of a perfect cube, while the silver version of the shade reflects its inspiration in salt crystals. By blowing a molten organic substance into a precise cold form, the skilled hands of our glassmakers create a unique light fixture of elemental, yet perfect shape. The gleaming surface of this hand-blown crystal cube is enclosed from three sides by a polished metal component in either silver or gold tones. The Pyrite Collection excels in both exceptional design and top-quality materials. Easily combined, it invites you to create your own unique lighting constellations.







Shibari

by Kateřina Handlová

THE SECRET LANGUAGE OF ROPE-KNOTS

Shibari is not simply the technique of tying objects with ropes, but a method of communication within hidden systems of lines and loops. In Japanese it's called Kinbaku: the beauty of tight binding. This sophisticated collection places crystal centerpieces amidst the knots to draw our attention and create variable compositions. Thanks to BOMMA's daring design, Shibari may be considered a work of art, whether as a stand-alone piece or in a grouping that resembles a sculpture.

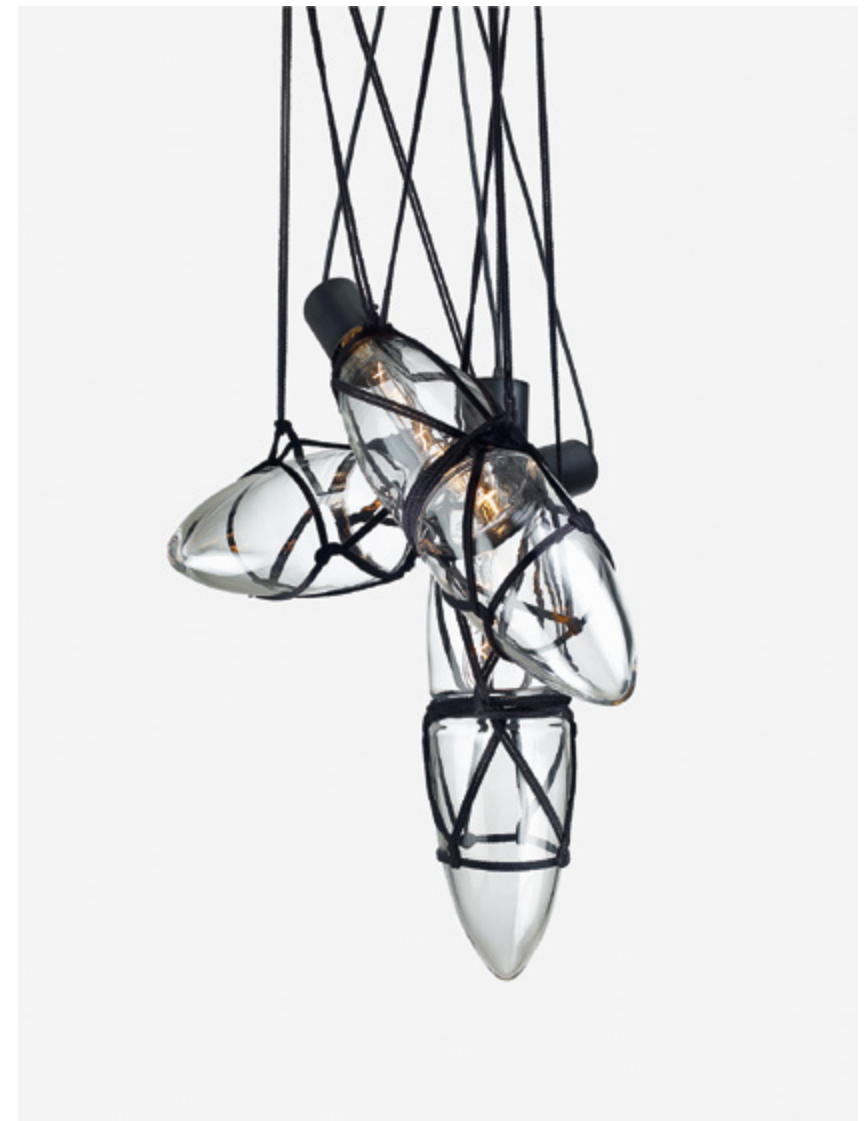





Soap Mini

by Ota Svoboda

THE MAGICAL QUALITY OF IRIDESCENCE

Varied colors, transparency and continuously changing shapes – the characteristic features of soap bubbles – inspired this BOMMA collection. When lighted, the metallic sheen of its surface transforms to iridescent and translucent, exposing its crystal character. The entire collection is produced using the technique of hand-blowing without a form. The seemingly perfect droplet of molten glass is given a unique shape as well as a unique color spectrum. The Soap Mini collection allows unlimited space for your creativity, with the option to create as large groups of crystal drops as you fancy – from smaller compositions to expansive light constellations.





BEYOND TRADITION

While fully grounded in Czech glassmaking history, BOMMA focuses on constant invention and innovation.

BEYOND CRAFT

BOMMA supports its exceptional master craftsmen with modern facilities and proprietary technologies.





Lens

by Studio deFORM

THE PERFECT OPTICS OF PURE CRYSTAL

Light refracted through a lens is a fundamental principle of optics. Here, two lenses harmoniously encapsulate their interior source, playing a monumental symphony of lights, tone by tone. This BOMMA collection is exceptional in its design and material selections, as well as its potential to create unique lighting constellations. Thanks to our special hand-painting technique, the predefined colors of the Lens Collection may be additionally expanded to meet a color variation of your choice. The lighting's hypnotic design, along with the delicate detail of its canopy, ensures that the collection forms a notable and supremely elegant interior element.

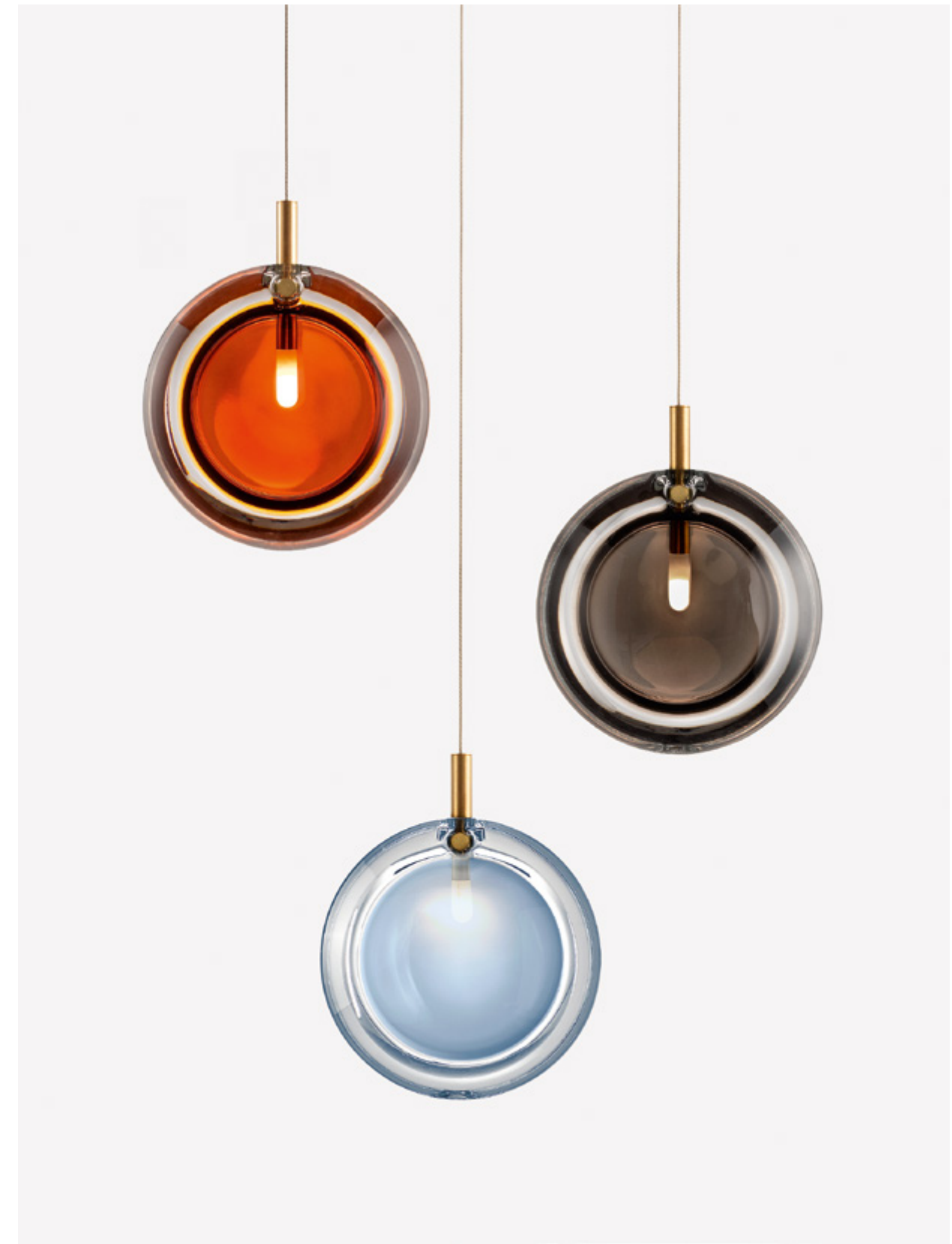





Umbra

by Dechem Studio

WITHOUT LIGHT, THERE IS NO SHADOW

Every detail of this lighting collection embodies the relation of geometric objects and their shadows with sophisticated elegance. Its metal plate derives from the perfectly elliptical shadow cast by a crystal ball and mirrors the refined color scheme of the mouth-blown piece. BOMMA's traditional glassmaking techniques ensure that each piece from this collection is truly an original. Its combination of perfect details, elemental shapes and delicate pastel colors makes Umbra a true jewel for your interiors.







Tim

by Studio Olgoj Chorchoj

THE MASTERY OF CLARITY

The inspiration for this unique collection was a collaboration with the world-renowned director Tim Burton, during one of his exhibitions. The Tim Collection was among our earliest efforts, based on the shapes of the glass cloches covering Burton's artworks. These monumental pieces marked BOMMA's entry to the world of top-level lighting design and set us on our path. Free-blown glass without the use of a form, literally reaches the limits of this size and weight. Unique in the world-wide scale, these lights combine minimalistic design with the greatest examples of glassmaking mastery.







Dark & Bright Star

by Dechem Studio

THE ENDLESS DUEL OF LIGHT AND DARKNESS

Like distant stars, these seemingly small lighted objects impress with both their design and craft. The light source is placed within a mouth-blown piece, shining from the center of a precisely cut crystal star. This BOMMA collection is characterized by combining seemingly incompatible contrasts - light and darkness in an exact vision of the creator as it combines the irregularity of traditional hand production, along with crystal luster and a smooth matte cut. These individual light fixtures may be combined as you wish, creating unique one-off clusters. Dark & Bright Star is impressive as a solitaire, but even stronger in constellations.

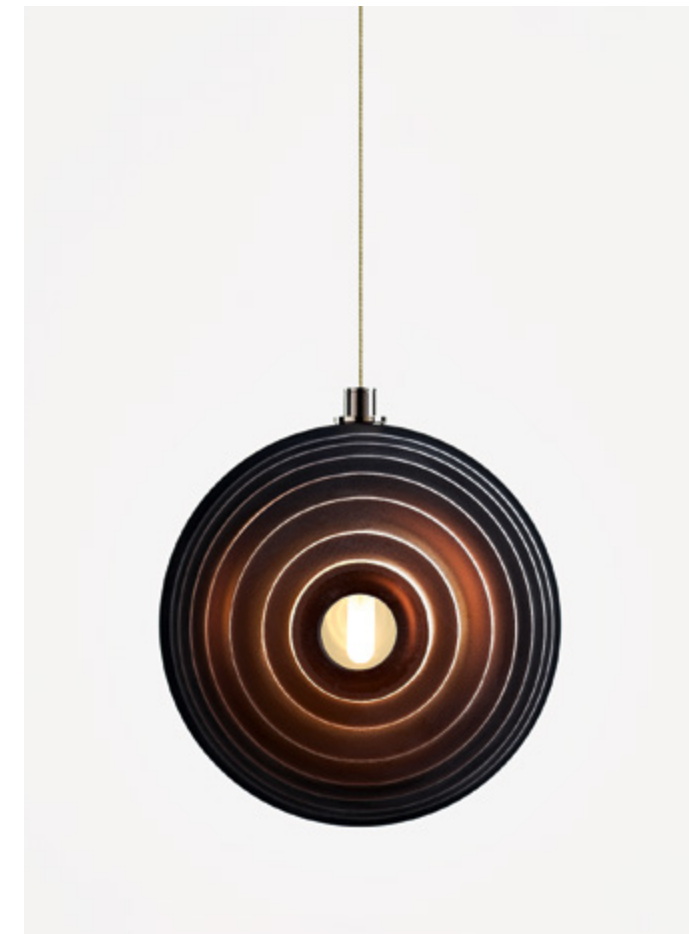
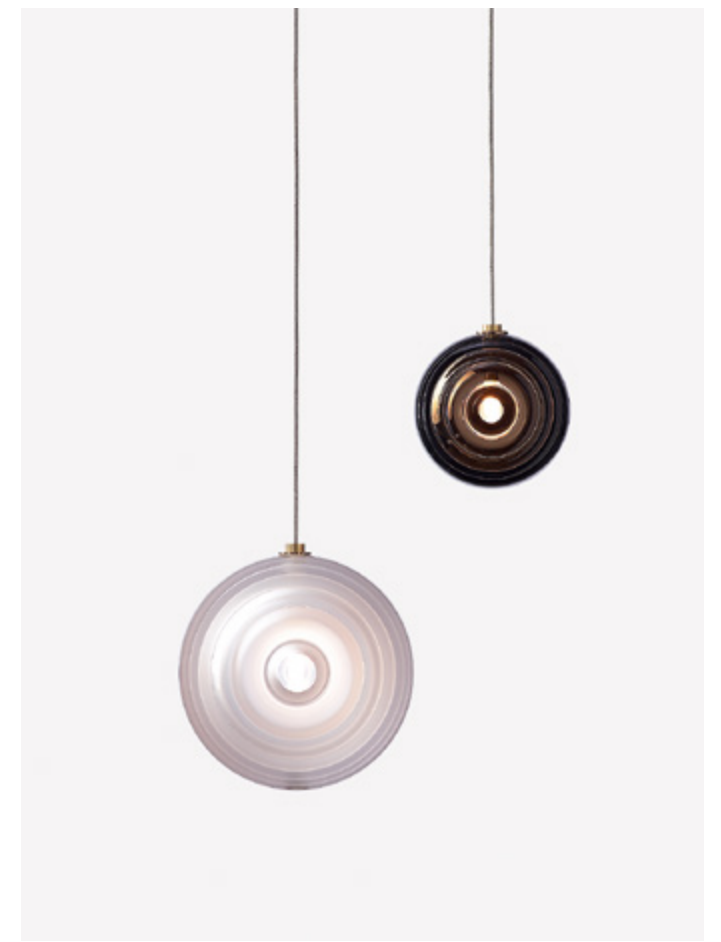





Pebbles

by Boris Klimek

KEEPSAKES OF TREASURED MEMORIES

Pebbles are reminders of exceptional moments or favorite places. Their diverse shapes and colors inspired BOMMA's playful collection that invites you to express your creativity. It provides options for creating distinctive combinations. Just as with stones, the crystal components of the Pebbles Collection are absolute originals, thanks to hand-blowing. String the colorful shapes onto its inner light source as you wish and create elegant objects that transform into artworks in any interior.







Tied-Up Romance

by Kateřina Handlová

THE BEAUTY IN CONTRADICTION

BOMMA's meticulously crafted leather and horsehair surrounding firmly embraces its hand-blown crystal elements. This unconventional romantic bond celebrates a world of contradictions and the permanent essence of glass. The original design of this collection combines two absolutely precise crafts - perfect leather processing and traditional glassmaking. While the object encased in black leather provokes with its strong bondage aesthetic, the natural-brown version at once highlights both the solidity and fragility of glass. Tied-Up Romance transcends the meaning of lighting to yet another level.



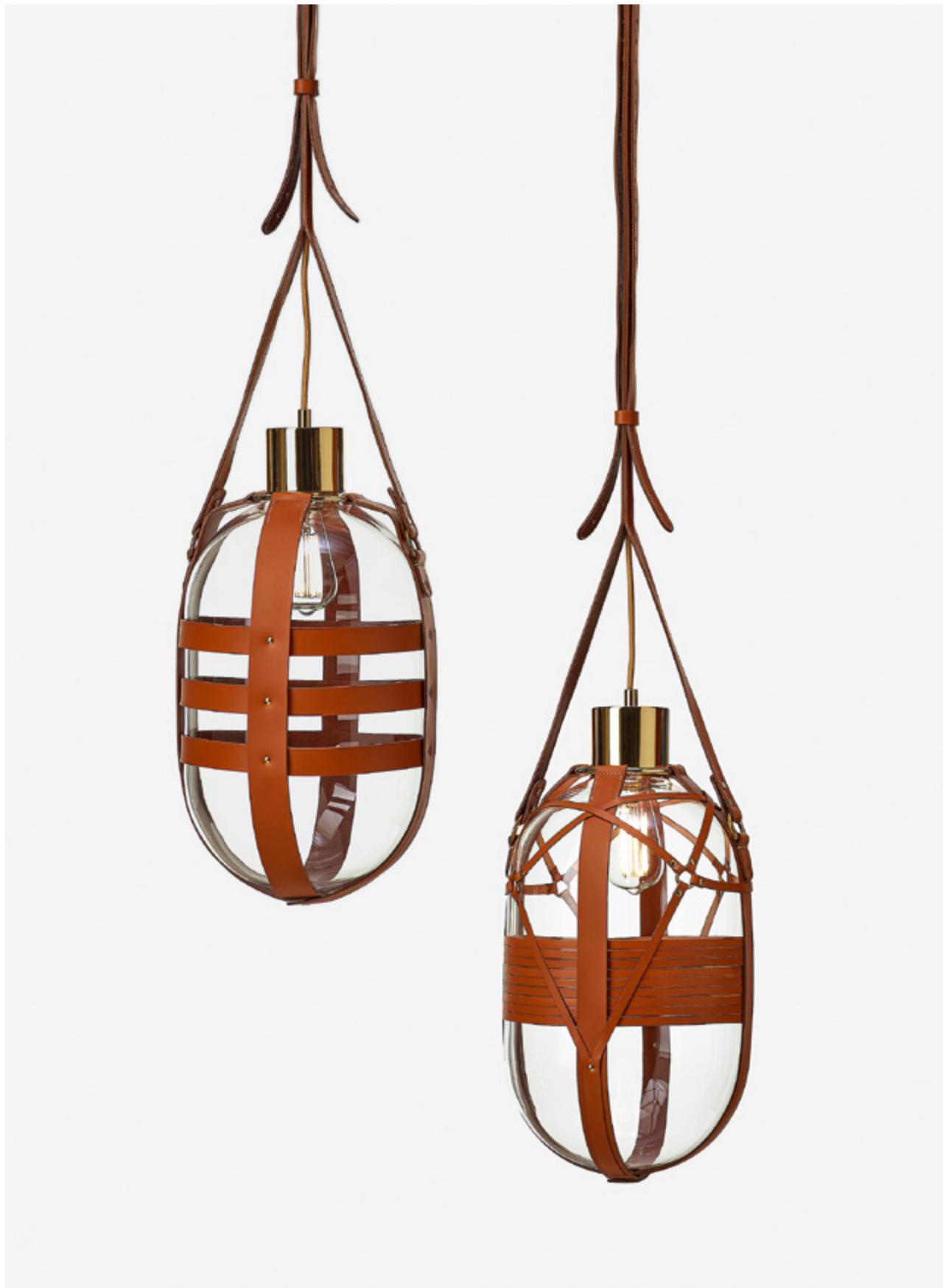



Orbital

by Studio deFORM

BRAVELY CROSSING GALACTIC PATHS

BOMMA's Orbital traces paths of multicolored celestial bodies that glow with hypnotically red-hot cores. This ingenious design of mouth-blown glass lenses, held together by a metal mounting, creates a fascinating visual experience from many different angles. Our unique lighting objects in Moon clear, Venus pink, Pluto green, Neptune blue, Polaris white and Mercury black, lend a truly magical atmosphere to any sophisticated interior.









Pendulum

by Studio deFORM

THE TIMELESS PLAY OF BALANCE

A BOMMA collection inspired by Newton's cradle, capturing the moment of an object in motion. The playful and colorful Pendulum combines the laws of physics and high esthetic requirements with top-quality craft, reminding us that the world is in continual motion. Each crystal object in the collection is hand-blown, contributing to a one-of-a-kind piece. Yet, thanks to an exceptional attention to detail, their combination with other components creates an almost spiritual sense of harmony. Color variations, along with the option to combine a greater number of shapes, enable you to express your own creativity and advance your individual approach to a new level.







Soap

by Ota Svoboda

THE MAGICAL QUALITY OF IRIDESCENCE

Varied colors, transparency and continuously changing shapes – the characteristic features of soap bubbles-inspired this BOMMA collection. When lighted, the metallic sheen of its surface transforms to iridescent and translucent, exposing its crystal character. The entire collection is produced using the technique of hand-blowing without a form. The seemingly perfect droplet of molten glass is given a unique shape, as well as a unique color spectrum. Among Soap Collection's main advantages are the options to create impressive compositions from a larger number of individual light fixtures or combining their color schemes.

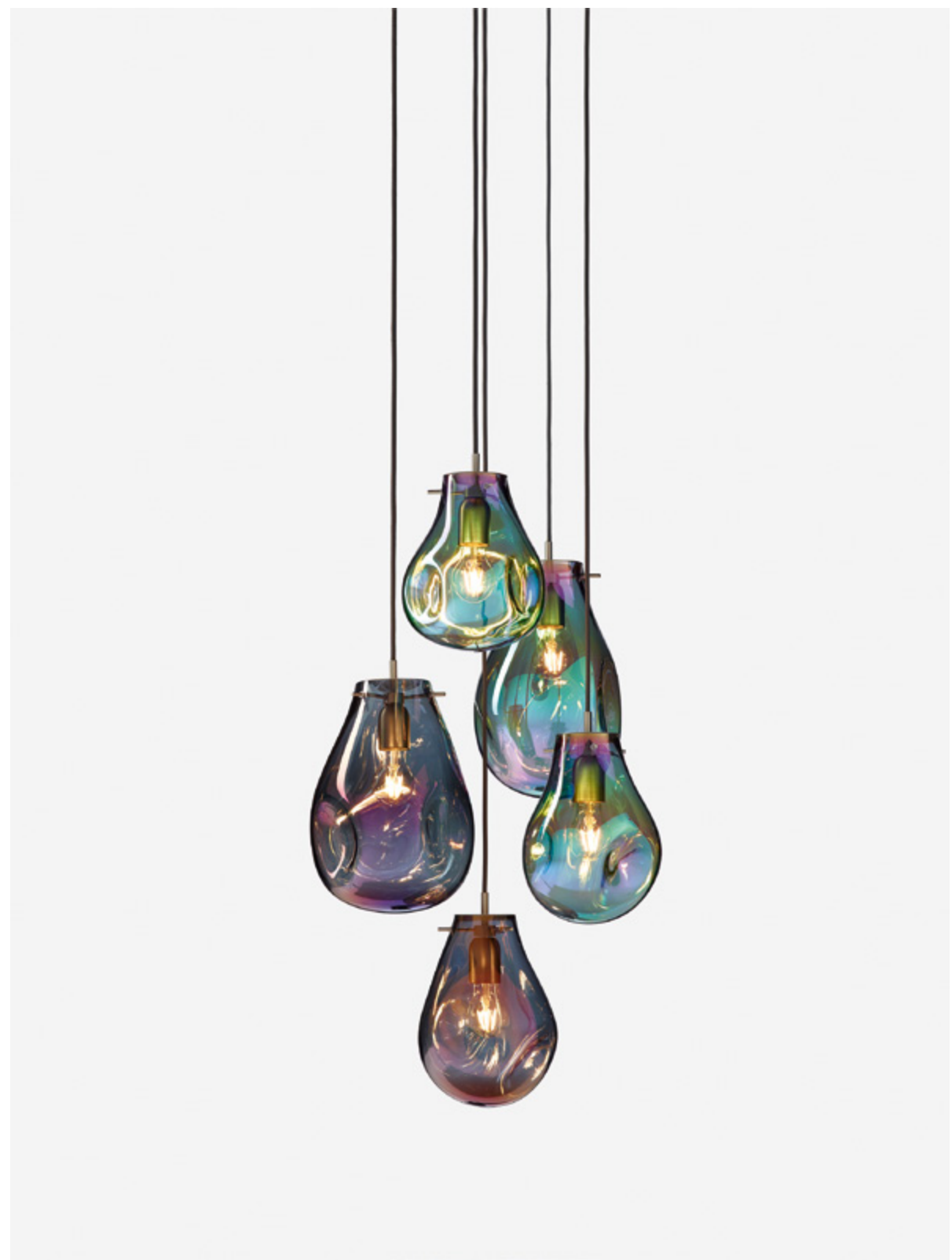



BEYOND LIMITS

BOMMA is renowned for constantly pushing the boundaries of what is humanly and technically possible.

BEYOND PASSION

Passion for glassmaking is a given, BOMMA is also dedicated to reliable quality, technical precision and excellent customer support.





Disc

by Studio Olgoj Chorchoj

A VISIT FROM THE OUTER-SPACE

The minimalist design of BOMMA's Disc Collection combines metal with the highest-quality crystal, shaped by master glassmakers to absolute perfection and hand-blown into wooden forms. The elemental shape is reminiscent of a flying saucer, floating through space. The friendly familiar form of this light fixture in clear, silver or copper finish adds its strong esthetic character to any interior. Metallic reflections add a further perspective to the object and shift our concepts about the possibilities of glass to a higher level.







Blimp

by Big-Game Studio

THE UNBEARABLE LIGHTNESS OF GLASS

This stunning and massive crystal cloud floats in space with the lightness of a zeppelin. Blimp is the largest lighting piece our master glassmakers are capable of creating by hand. Blowing into a metal form produces a graceful giant that is a testimony to human ingenuity and top-level craftsmanship. Although this creation is a dominant element in any interior, the clear version feels both light and airy. Its honey-golden version then fills the interior with a pleasant ambient light. The Blimp Collection is the result of BOMMA's first international collaboration with a team of Swiss designers who masterminded it upon their first experience with designing glass. The success of this double premier exceeded all expectations.







Phenomena

by Dechem Studio

TRANSIENT IMAGES OF THE ETERNAL

The name chosen for this BOMMA collection, inspired by basic geometric shapes, comes from the Greek word for 'appearances'. According to Plato's teachings, phenomena are mere transient images of eternal and perfect forms and thus inherently unreal. A fitting name for objects made of glass - a material that is both rigid and flexible, as well as strong, yet fragile. These lighting fixtures, in an array of fascinating sizes, are hand-blown into custom-made forms that combine both clear and colored glass. The color gradient is created by being gradually blown into the molten mass, as if breathing life into this collection. The flawlessly smooth shape of the crystal light is accented by a sophisticated polished mounting, highlighting a perfect blend of materials and aesthetics.





LIGHTING COLLECTIONS,
CONSTELLATIONS AND BESPOKE PROJECTS

Each space is unique and we are ready to work with you to create a one-of-a-kind solution. Cherishing our founding values of original design, high quality and traditional craftsmanship, we proudly present three options that enable owners, creators, architects and designers to transform their interiors.

BOMMA Collections

BOMMA crystal lighting collections are designed to bring emotion, delight and beauty to both traditional and modern spaces. They draw attention thanks to their inventiveness, quality and, often, an awe-inspiring size. BOMMA lights are intended to impress as stunning centerpieces, creative groups or, if you wish, large clusters that fill entire rooms.

BOMMA Constellations

BOMMA Constellations is a special concept, working with designers to arrange smaller lighting pieces into variably sized groups. Project your boldest creative visions into space - from smaller compositions to unlimited constellations. Choose among four original collections: *Pyrite*, *Dark & Bright Star*, *Lens* or *Soap Mini*. Like distant stars, these seemingly small lighted objects shine when installed alone and become even stronger in groups. Each single pendant is remarkable in its aesthetics, quality, design and craft. These four BOMMA Collections are available to be combined, customized and mixed according to your vision.

BOMMA Bespoke

Aside from original BOMMA Collections, our designers seek out creative collaborations and challenging bespoke projects. Together, we can produce one-of-a-kind installations specifically for your interiors. As a progressive glass manufacturer with our own highly modern production facility, we are able to create custom designs based on your vision and technical requirements. Our team provides hands-on support from your initial sketches to our final production.

COLOR AND SIZE OPTIONS

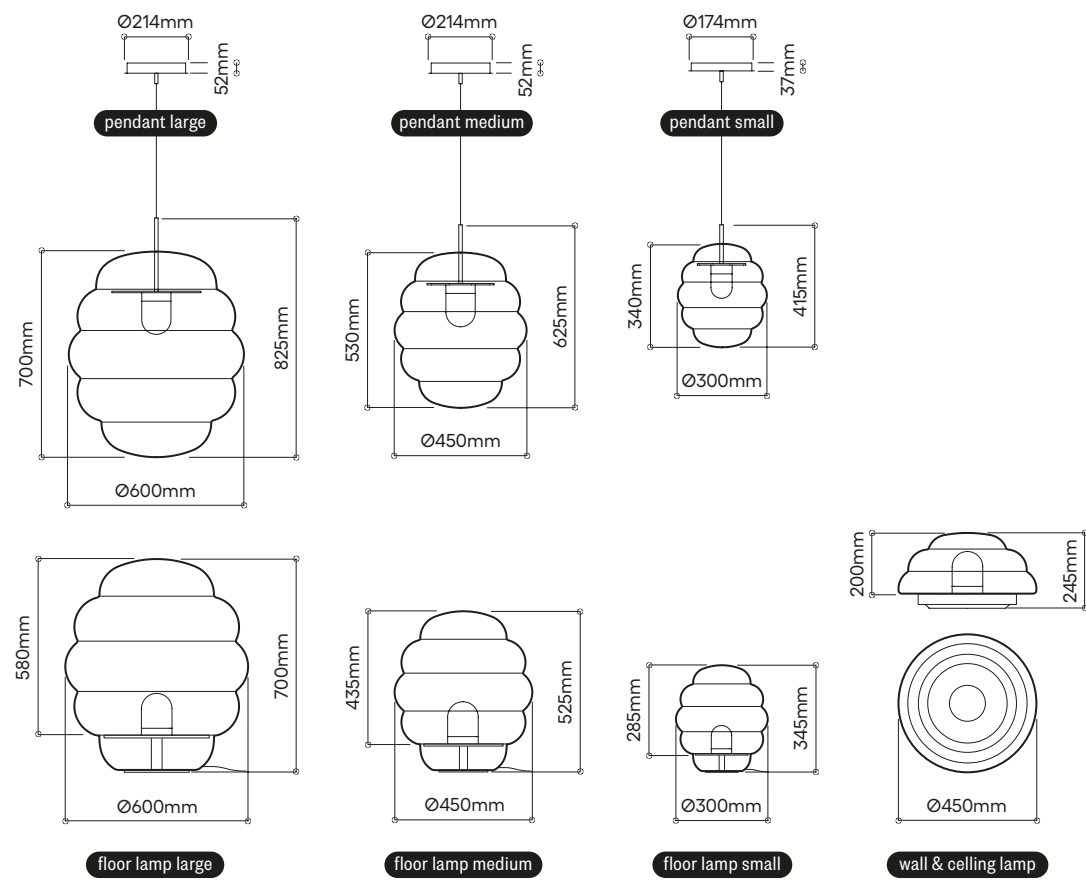

Blimp p. 128-133

- glass options
 • clear
 • amber
- mounting color
 • black

The glass parts of Blimp are mouth-blown thus the intensity of color may slightly vary.

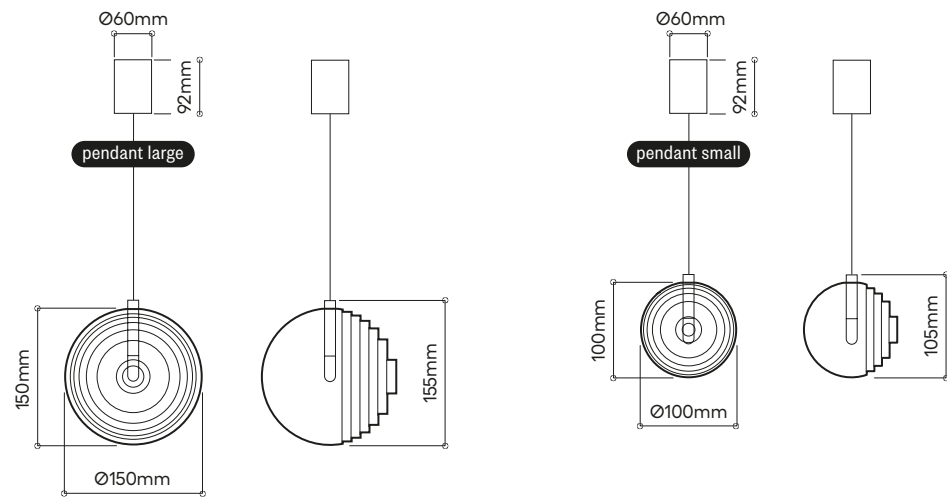

Dark & Bright Star p. 82-87

- glass options
 • dark
 • bright
- mounting colors
 • brushed gold
 • anthracite

The Stars are mouth-blown, then defined by precise cut.

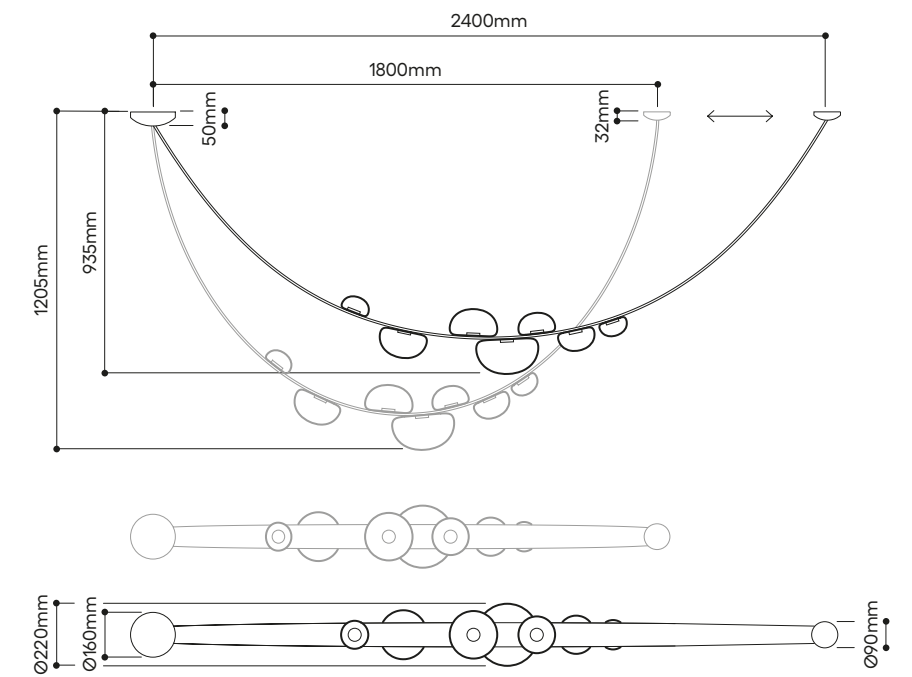
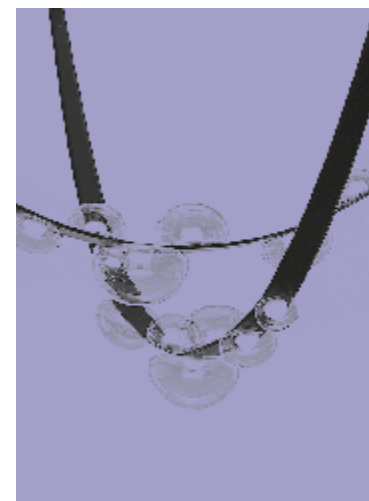

Dew Drops p. 32-37

- glass option
 • iridescent
 metal-coating
- band materials
 • vegan leather
 • leather

The glass parts of Dew Drops are mouth-blown thus the intensity of the iridescent metal-coating may slightly vary.

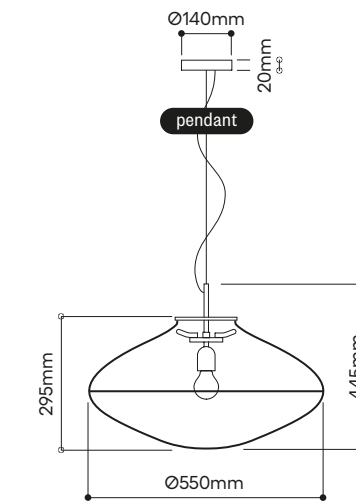

Disc p. 121-127

- glass option
 • clear
- mounting colors
 • silver
 • copper
 • black
- glass option
 • silver
- mounting color
 • silver
- glass option
 • copper
- mounting color
 • copper

The glass parts of Discs are mouth-blown. The colored Discs are then metal-coated, thus the intensity of color may slightly vary.



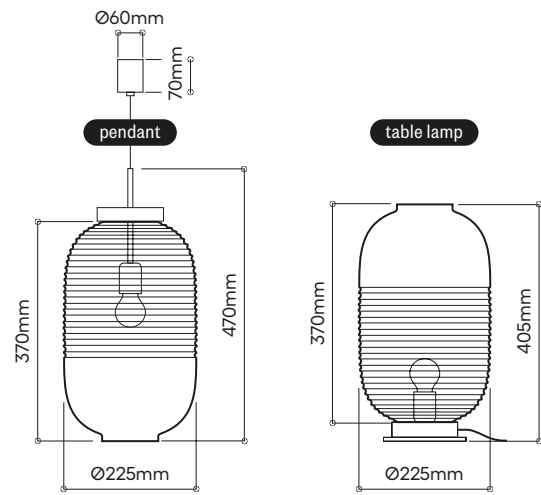

Lantern

p. 38-43

- glass options
- clear
 - white
 - smoke grey
- mounting colors
- patina gold
 - black

The glass parts of Lantern are mouth-blown thus the intensity of color and gradient may slightly vary.

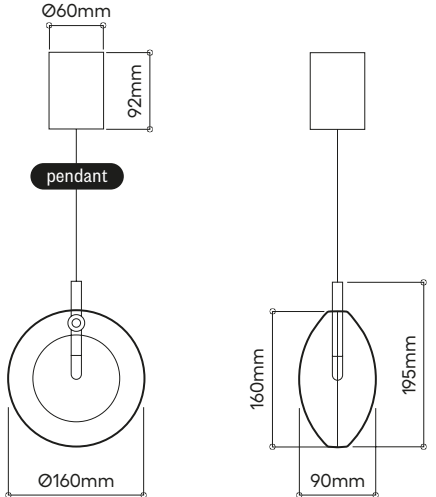

Lens

p. 63-69

- glass options
- clear
 - white
 - amber
 - smoke
 - blue grey
- mounting color
- brushed gold

Thanks to the special hand-painting technique, we can produce the Lens collection in any tone that suits your specific needs.

The glass parts of Lens are hand-painted thus the intensity of color may slightly vary.

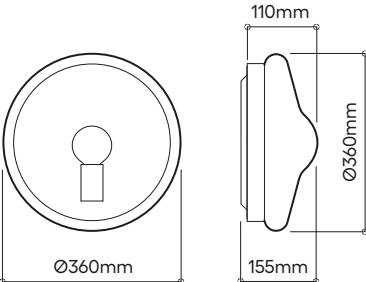
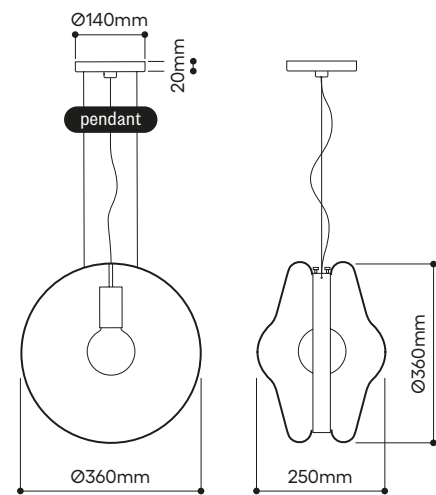
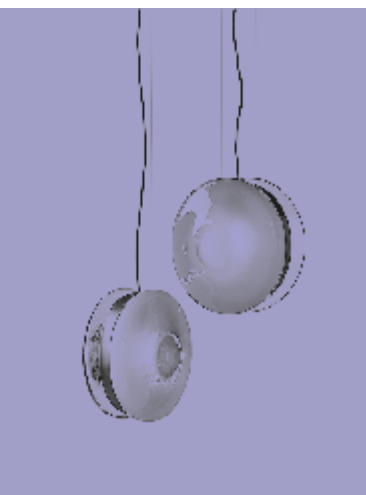

wall & ceiling lighting

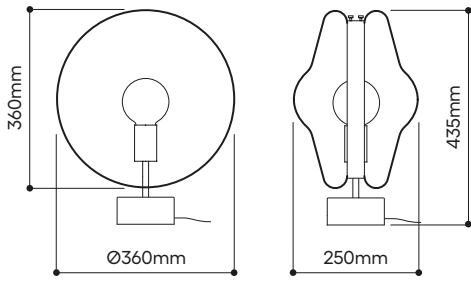
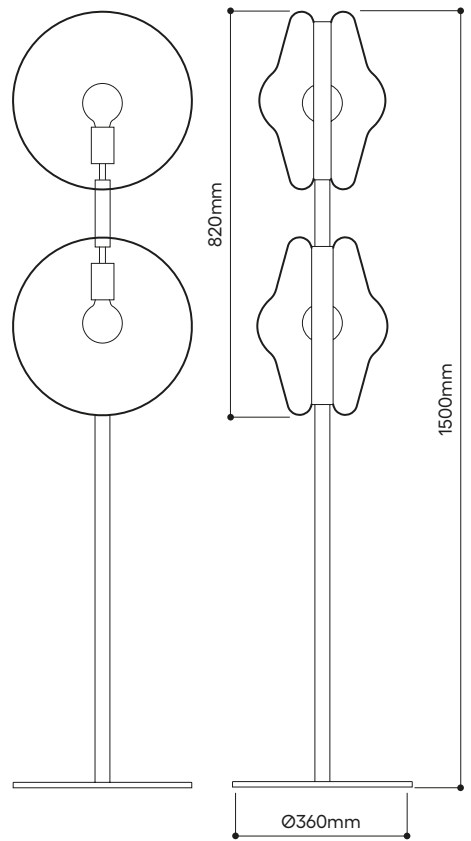

table lamp



floor lamp

Orbital

p. 100-107

pendant	wall & ceiling lighting	table lamp	floor lamp
<p>glass options</p> <ul style="list-style-type: none"> • moon clear • polaris white • neptune blue • mercury black • venus pink • pluto green <p>mounting colors</p> <ul style="list-style-type: none"> • patina gold • silver 	<p>glass options</p> <ul style="list-style-type: none"> • moon clear • polaris white • neptune blue • mercury black • venus pink • pluto green <p>mounting colors</p> <ul style="list-style-type: none"> • patina gold • silver 	<p>glass options</p> <ul style="list-style-type: none"> • moon clear • polaris white • neptune blue • mercury black • venus pink • pluto green <p>mounting colors</p> <ul style="list-style-type: none"> • patina gold • silver 	<p>glass options</p> <ul style="list-style-type: none"> • moon clear • polaris white • neptune blue • mercury black • venus pink • pluto green <p>mounting colors</p> <ul style="list-style-type: none"> • black • gold

The glass parts of Orbital are mouth-blown thus the intensity of color and gradient may slightly vary.



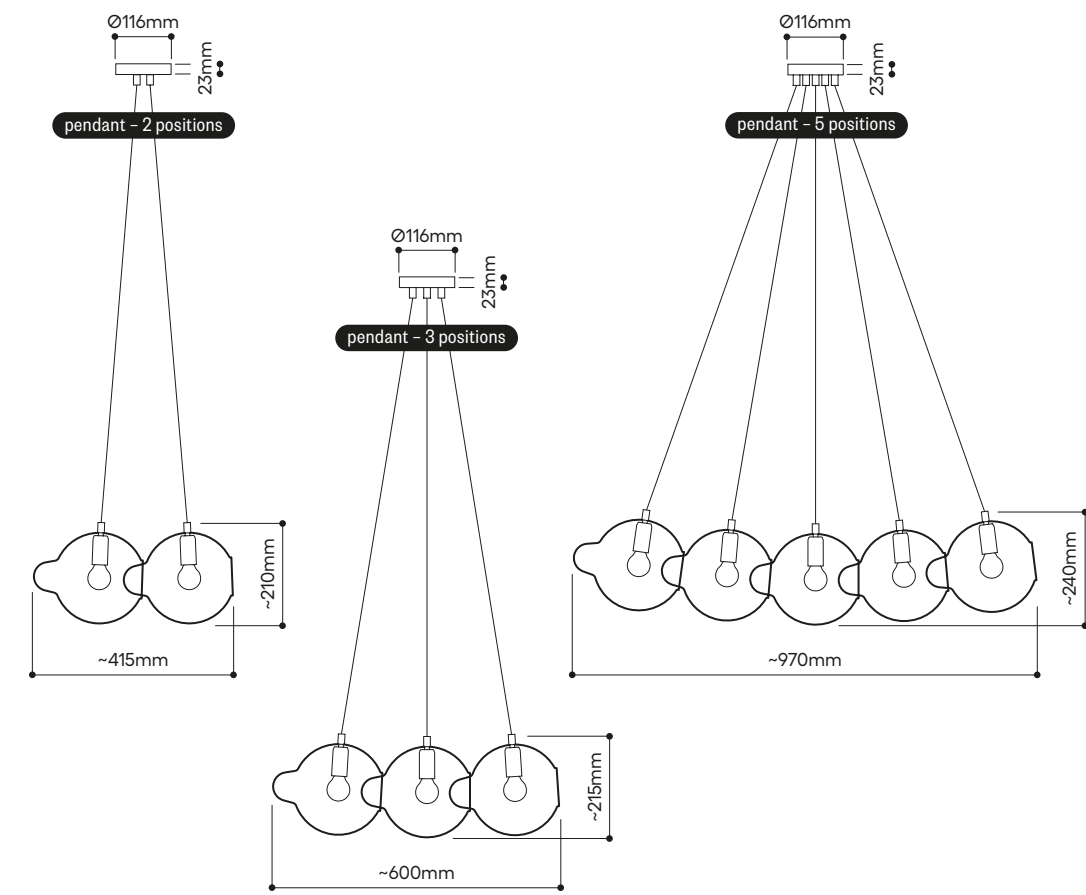
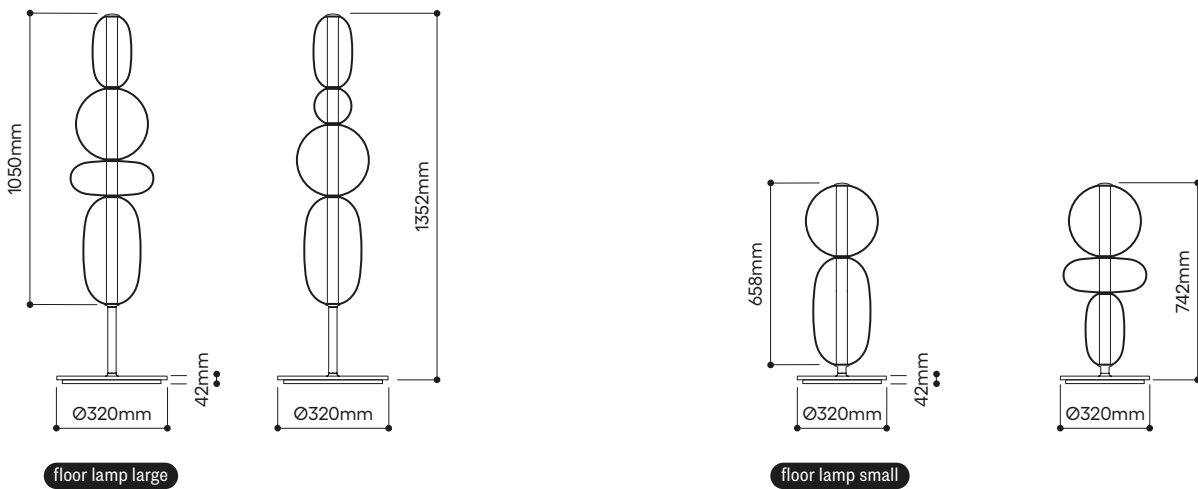
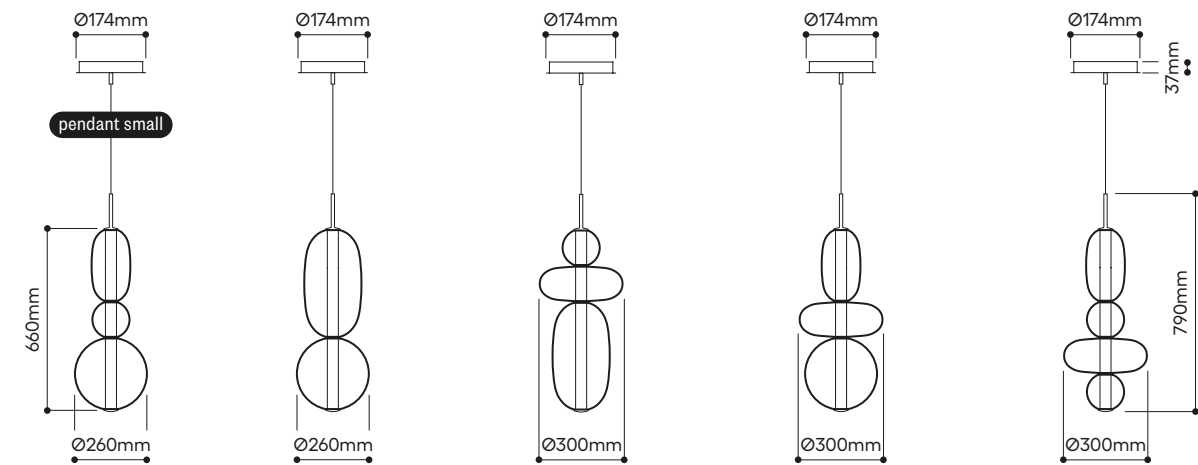
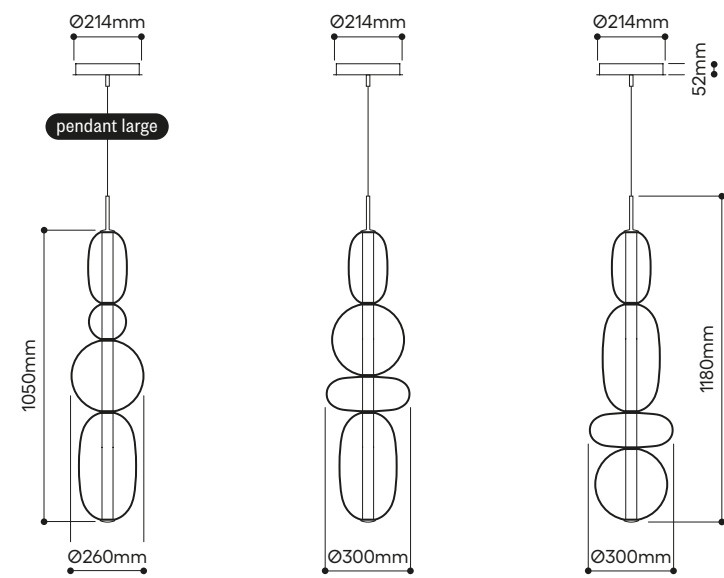

Pendulum p. 108-113

glass options
 • light grey
 • dark red
 • flamingo pink
 • pigeon blue

mounting colors
 • black
 • white

Pick from standard configurations or select the colors of glass components according to your imagination.

The glass parts of Pendulum are mouth-blown thus the intensity of color and gradient may slightly vary.



Pebbles p. 88-93

glass options
 • black
 • light grey
 • white
 • green
 • red

mounting color
 • black

Pick from standard configurations or use the Pebbles Configurator to compose your own.

The glass parts of Pebbles are mouth-blown thus the intensity of color and gradient may slightly vary.



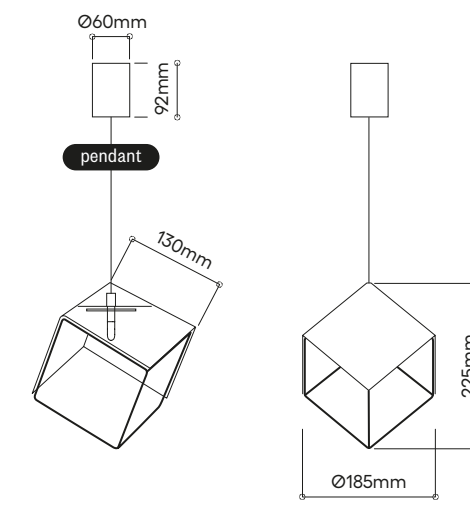
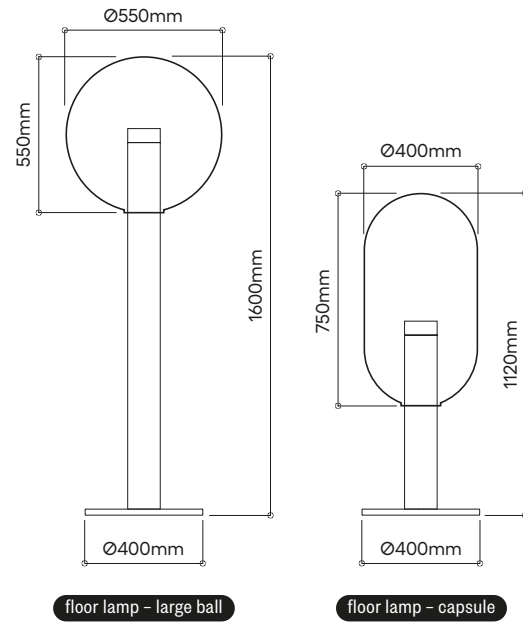
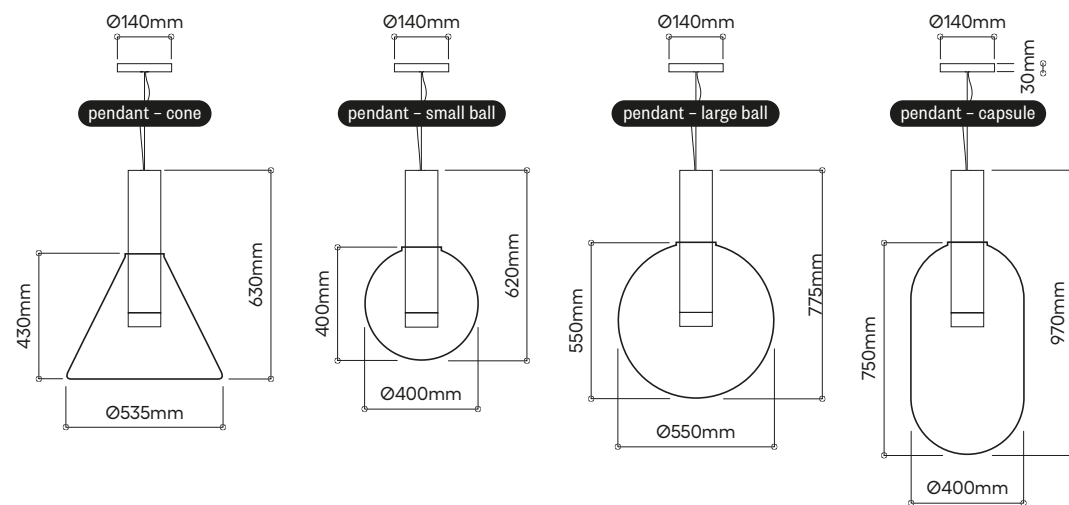

Pyrite p. 44-49

- glass option
- clear
- mounting colors
- gold
 - silver

The glass parts of Pyrite are mouth-blown thus the surface structure may slightly vary.



Phenomena p. 134-139

<p>pendant - cone</p> <p>glass option</p> <ul style="list-style-type: none"> • smoke grey <p>mounting colors</p> <ul style="list-style-type: none"> • silver • gold 	<p>pendant - small ball</p> <p>glass options</p> <ul style="list-style-type: none"> • ferrari red • smoke grey <p>mounting colors</p> <ul style="list-style-type: none"> • silver • gold 	<p>pendant - large ball</p> <p>glass options</p> <ul style="list-style-type: none"> • flamingo pink • smoke grey <p>mounting colors</p> <ul style="list-style-type: none"> • silver • gold 	<p>pendant - capsule</p> <p>glass options</p> <ul style="list-style-type: none"> • mint green • smoke grey <p>mounting colors</p> <ul style="list-style-type: none"> • silver • gold
--	--	--	--

The glass parts of Phenomena are mouth-blown thus the intensity of color and gradient may slightly vary.



<p>floor lamp - large ball</p> <p>glass options</p> <ul style="list-style-type: none"> • flamingo pink • smoke grey <p>mounting colors</p> <ul style="list-style-type: none"> • silver • gold 	<p>floor lamp - capsule</p> <p>glass options</p> <ul style="list-style-type: none"> • mint green • smoke grey <p>mounting colors</p> <ul style="list-style-type: none"> • silver • gold
---	---

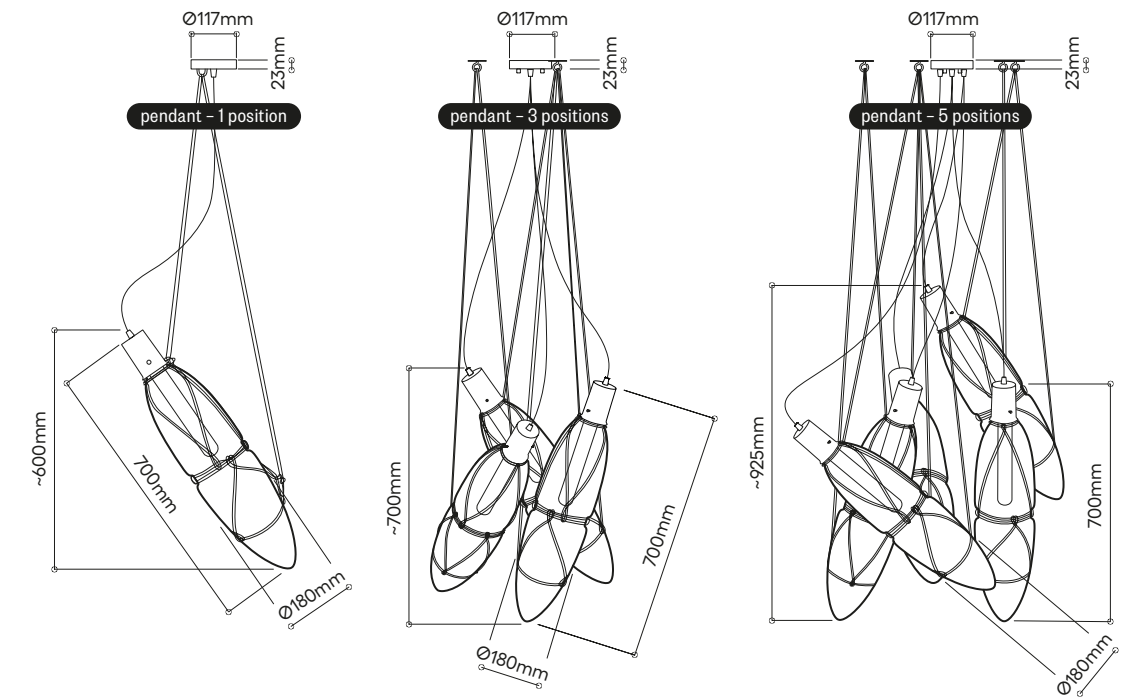

Shibari p. 50-55

- glass option
- clear
- mounting color
- black

The glass parts of Shibari are mouth-blown.



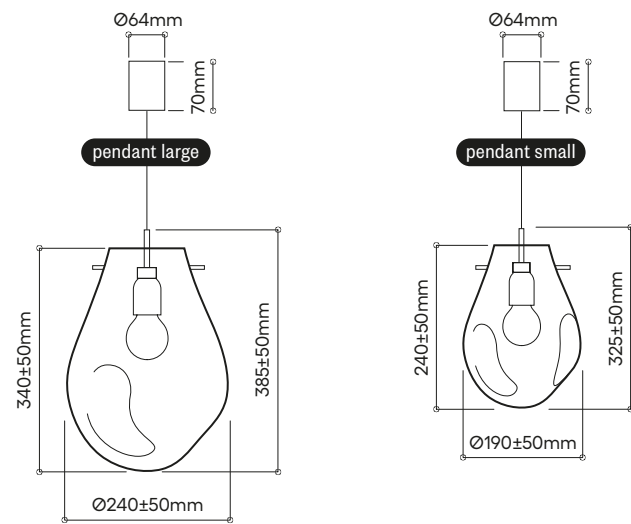

Soap p. 114–118

- | | |
|---------------|------------------|
| glass options | mounting color |
| • silver | • brushed silver |
| • gold | |
| • blue | |
| • purple | |
| • green | |
| • clear | |
| • frosted | |

The glass parts of Soap are mouth-blown without a mould thus the shape and size may slightly vary.

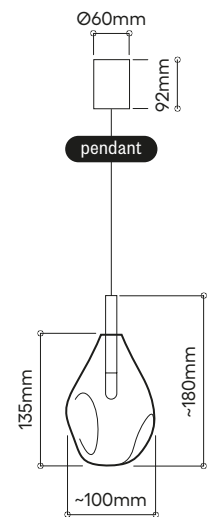

Soap Mini p. 56–60

- | | |
|---------------|-----------------|
| glass options | mounting colors |
| • silver | • anthracite |
| • gold | • brushed gold |
| • blue | |
| • clear | |
| • frosted | |

The glass parts of Soap Mini are mouth-blown into a mould thus the intensity of color may slightly vary.

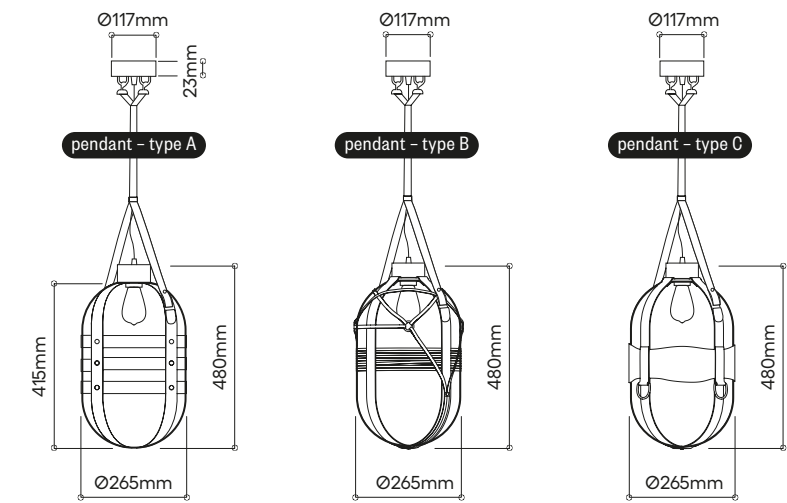
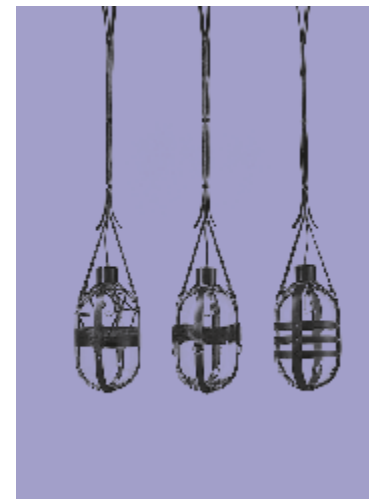

Tied-Up Romance p. 94–99

- | | |
|--------------|------------------------------------|
| glass option | mounting colors |
| • clear | • black leather with black details |
| | • brown leather with gold details |

The glass parts of Tied-Up Romance are mouth-blown.

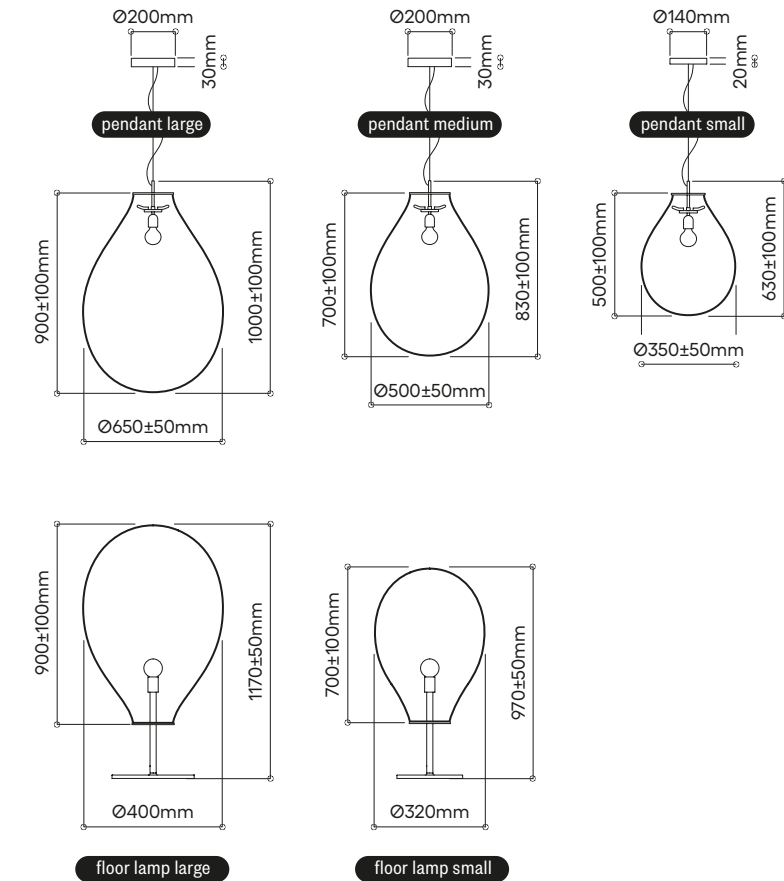

Tim p. 76–81

- | | |
|-----------------|----------------|
| pendant | floor lamp |
| glass options | glass options |
| • clear | • clear |
| • smoke grey | • smoke grey |
| mounting colors | mounting color |
| • silver | • black |
| • copper | |
| • black | |

The glass parts of Tim are mouth-blown without a mould thus the size and shape may slightly vary.



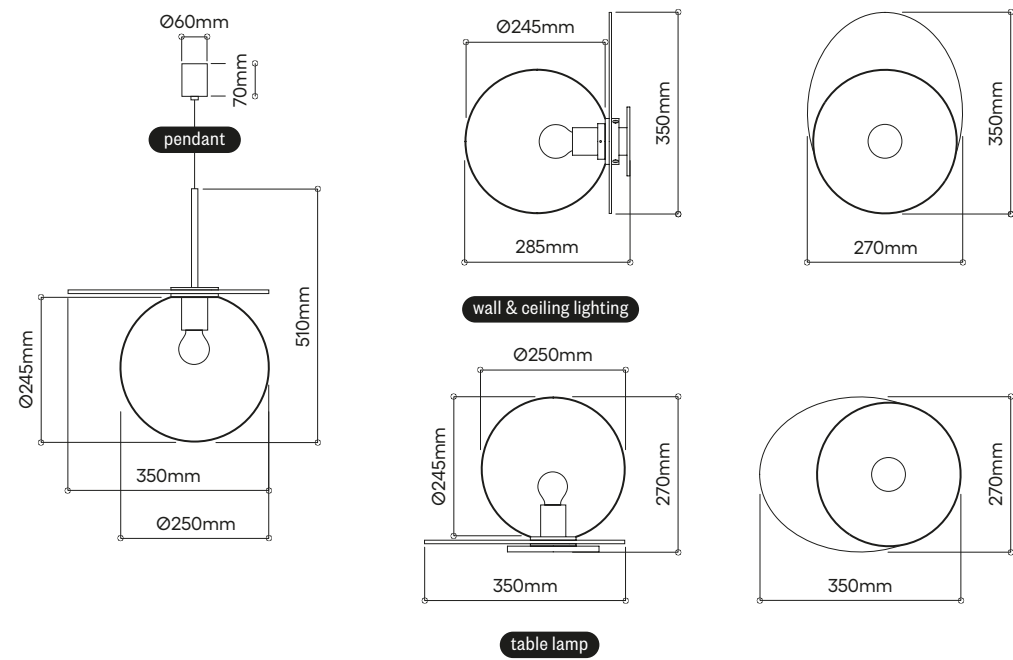

Umbra p. 70-75

- | | | |
|--|--|--|
| <p>glass options</p> <ul style="list-style-type: none"> • smoke grey • pink • blue • clear • light grey | <p>mounting color</p> <ul style="list-style-type: none"> • gold | <p>glass-mirror color</p> <ul style="list-style-type: none"> • reversible blue / gold |
|--|--|--|

The glass parts of Umbra are mouth-blown thus the intensity of color and gradient may slightly vary.



CHANDELIERS

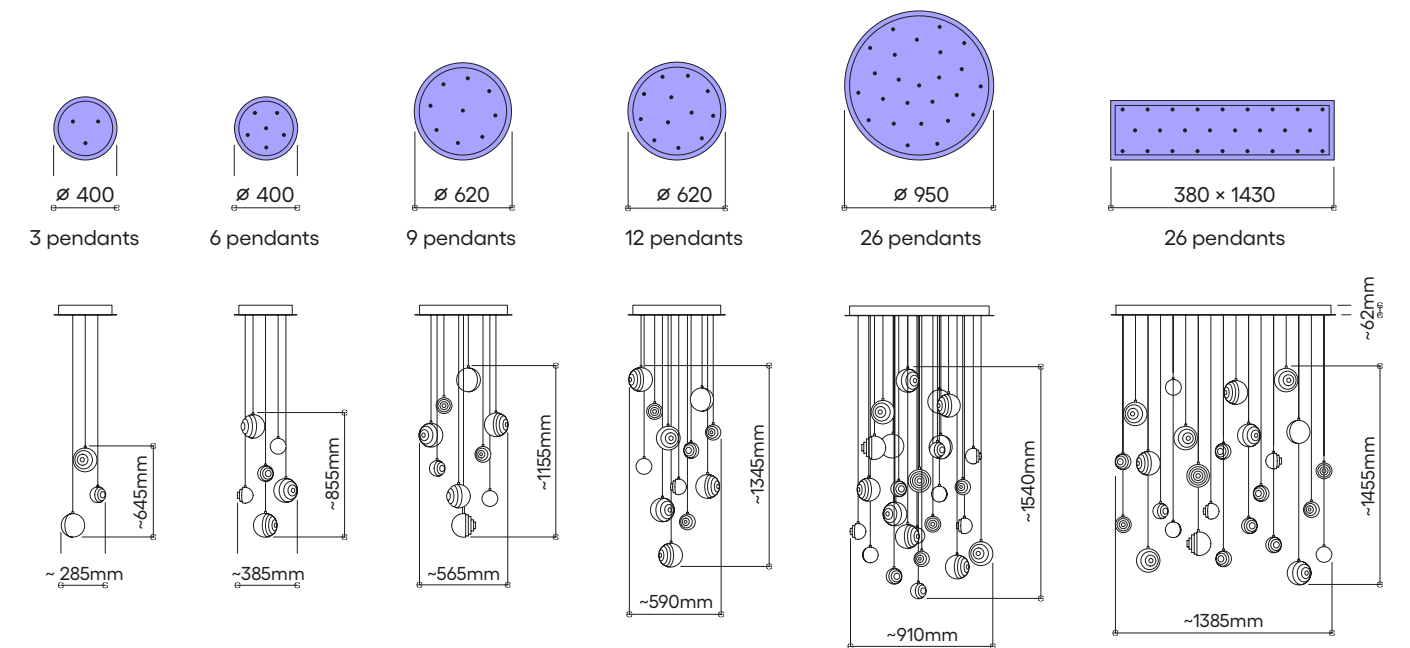
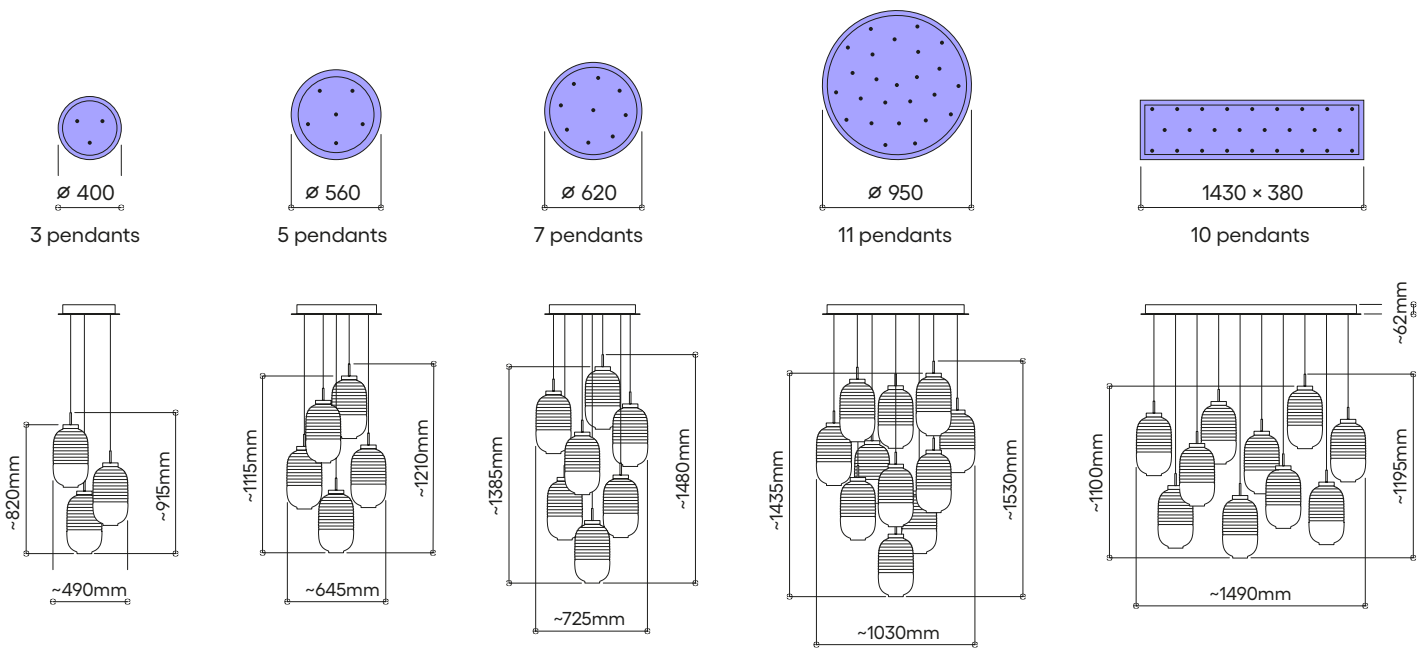

Lantern p. 38-43

The standard color of the canopy is white.
The color, metal-coating material and sizes
of the canopy are customizable upon request.

Dark & Bright Star p. 82-87

The standard color of the canopy is white.
The color, metal-coating material and sizes
of the canopy are customizable upon request.

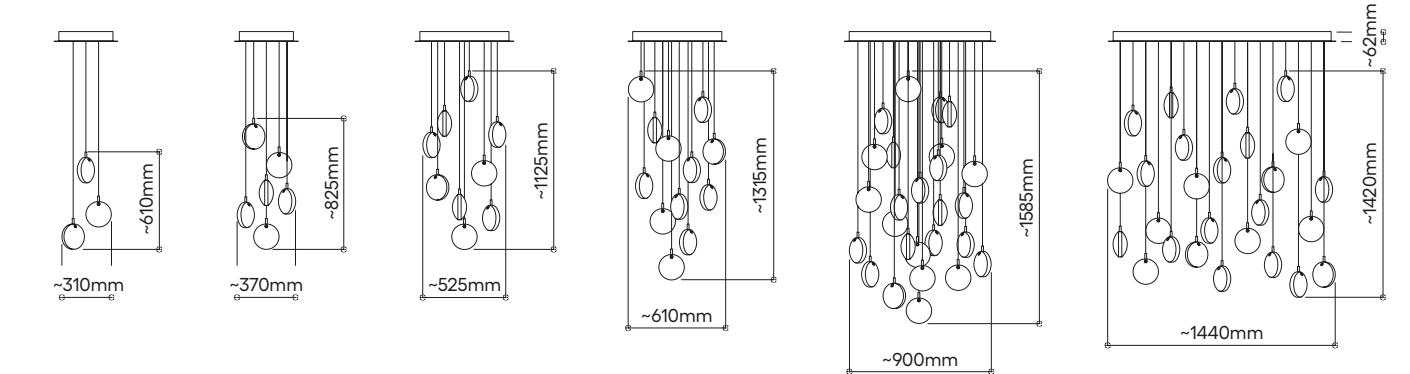
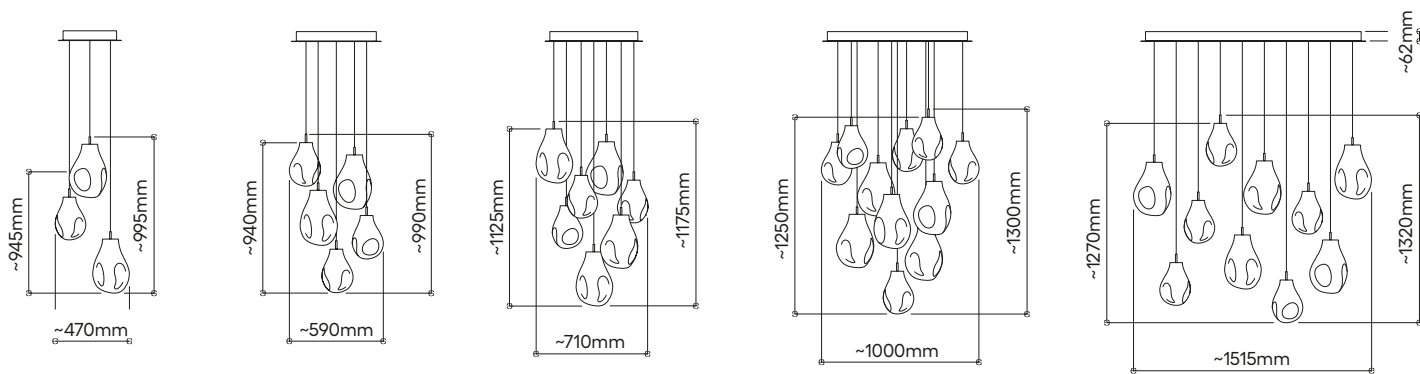

Soap p. 114-118

The standard color of the canopy is white.
The color, metal-coating material and sizes
of the canopy are customizable upon request.

Lens p. 63-69

The standard color of the canopy is white.
The color, metal-coating material and sizes
of the canopy are customizable upon request.

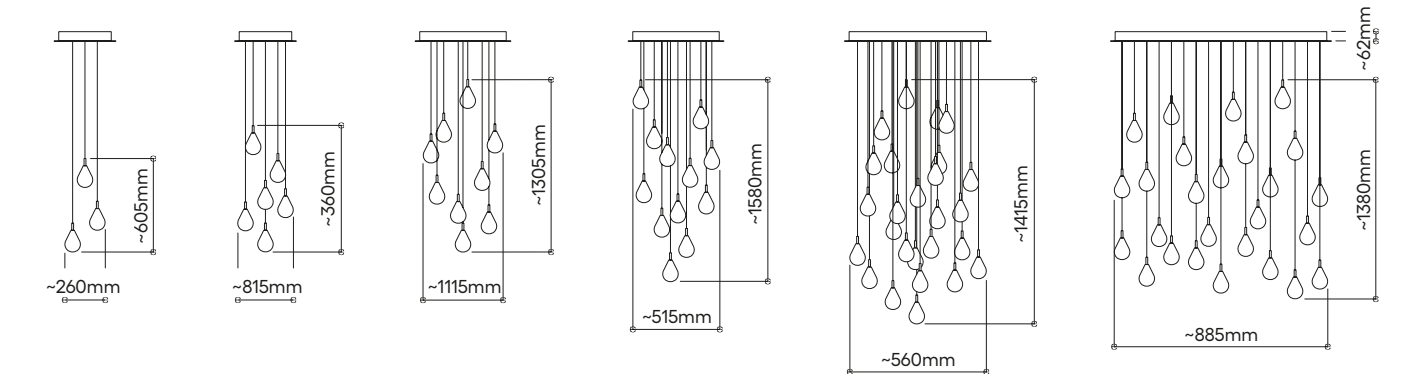
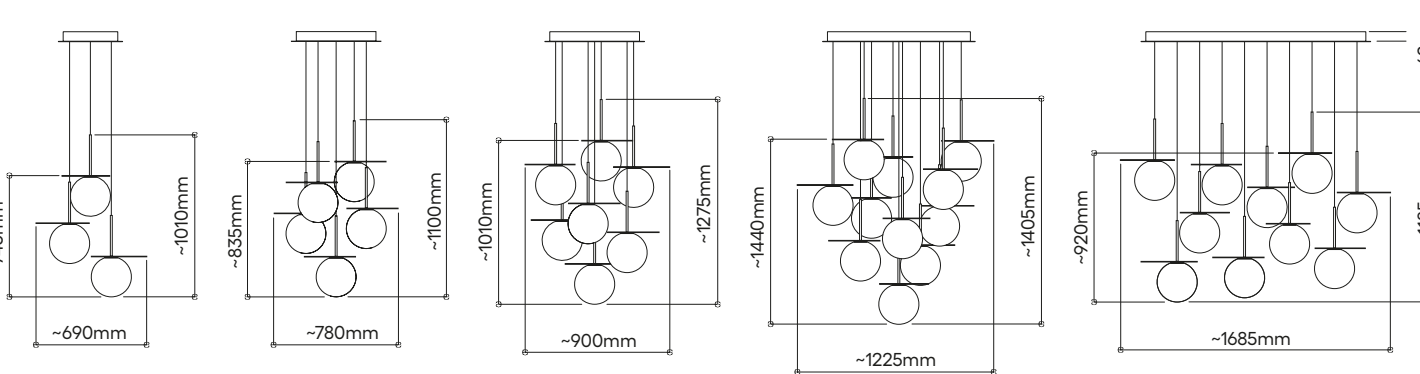

Umbra p. 70-75

The standard color of the canopy is white.
The color, metal-coating material and sizes
of the canopy are customizable upon request.

Soap Mini p. 56-60

The standard color of the canopy is white.
The color, metal-coating material and sizes
of the canopy are customizable upon request.

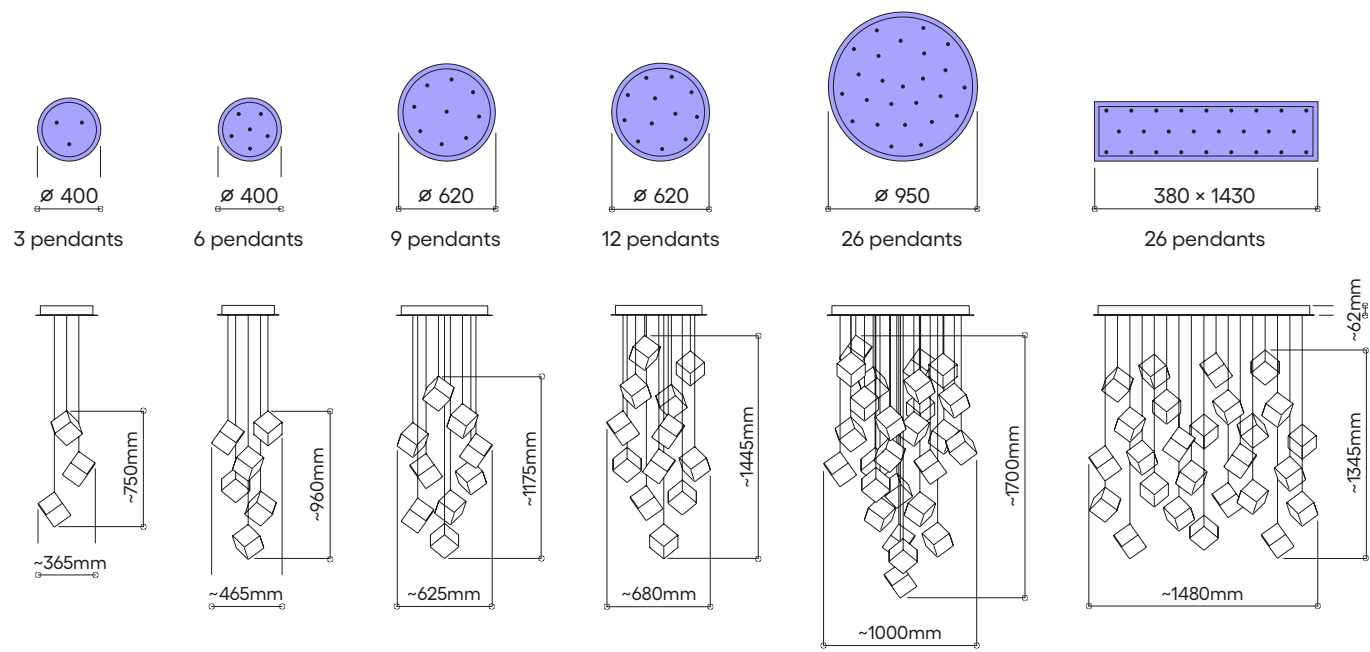

Pyrite p. 44-49

The standard color of the canopy is white.
 The color, metal-coating material and sizes
 of the canopy are customizable upon request.

OBJECTS

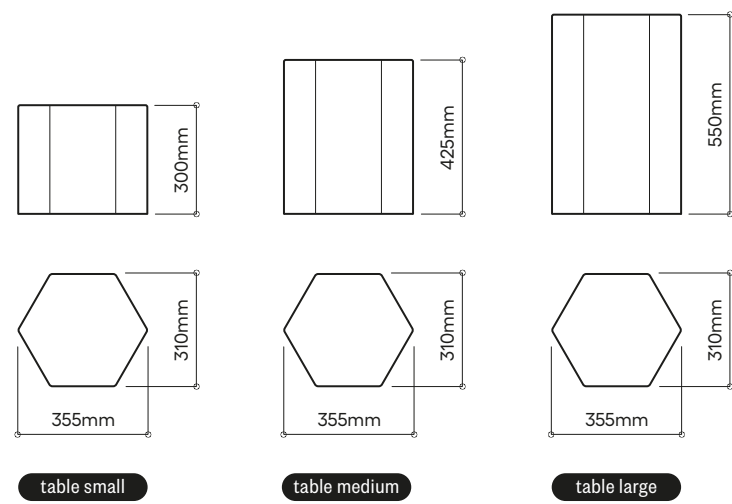

table small

table medium

table large

Hex Table

table small

glass option
• clear

table medium

glass options
• clear
• ocean blue
• fire red

table large

glass option
• clear

The Hex Tables are mouth-blown thus the intensity of color may slightly vary.

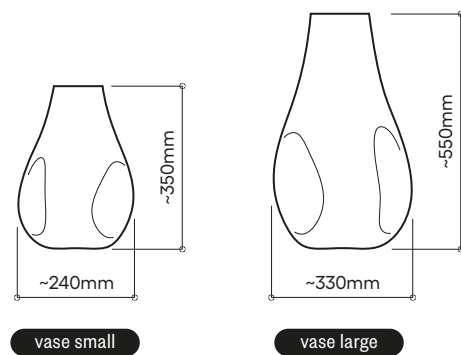

vase small

vase large

Soap Vase

glass options
• blue
• silver
• gold

The glass part of Soap Vase is mouth-blown without a mould thus the shape and size might slightly vary.

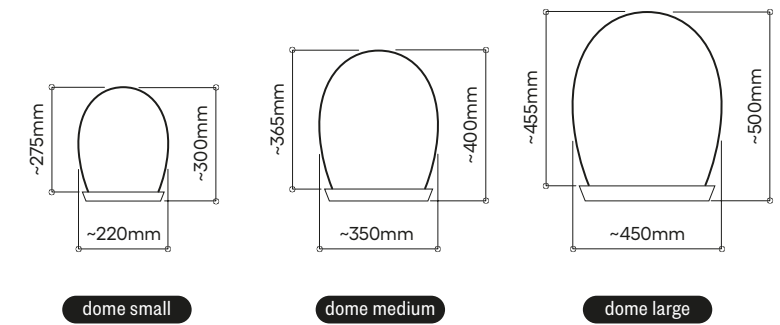

dome small

dome medium

dome large

Tim Dome

option

• clear glass with oak wood

The glass part of Tim Dome is mouth-blown without a mould thus the size and shape might slightly vary.



BOMMA

Catalog Creative Director: Václav Mlynář
Image Photography: Luboš Rezler, Filip Marek,
Janek Palovský
Product Photography: Martin Chum, Petr Krejčí,
Salim Issa, Anna Pleslová
Production Photography: Martin Faltejsek
Graphic Design: Anymade Studio
Copy and Translations: Michaela and Jim Freeman
Special Thanks to: Agapecasa, DeCastelli, Ligne Roset,
Masopust Store, Palermo Uno, Warli
© Bomma 2021

Contact Bomma
Zámecká 1177
58291 Světlá nad Sázavou
Czech Republic
info@bomma.cz

Follow www.bomma.cz
[Instagram@bomma_cz](https://www.instagram.com/bomma_cz)
[Facebook @bommacz](https://www.facebook.com/bommacz)
[YouTube @Bomma Lighting](https://www.youtube.com/channel/UCBommaLighting)
[Pinterest @bommacz](https://www.pinterest.com/bommacz)

LIGHTING COLLECTIONS

Dew Drops	Nature's Gems on Blades of Grass
Lantern	When Glass Embodies Paper
Pyrite	The Fiery Stone from the Core of the Earth
Shibari	The Secret Language of Rope-Knots
Soap Mini	The Magical Quality of Iridescence
Lens	The Perfect Optics of Pure Crystal
Umbra	Without Light, There Is No Shadow
Tim	The Mastery of Clarity
Dark & Bright Star	The Endless Duel of Light and Darkness
Pebbles	Keepsakes of Treasured Memories
Tied-Up Romance	The Beauty in Contradiction
Orbital	Bravely Crossing Galactic Paths
Pendulum	The Timeless Play of Balance
Soap	The Magical Quality of Iridescence
Disc	A Visit from the Outer-Space
Blimp	The Unbearable Lightness of Glass
Phenomena	Transient Images of the Eternal